

 MITSUBISHI MATERIALS

WIERTŁA



DIA  **EDGE**

NEW

MITSUBISHI MATERIALS

PRZEDSTAWIA SWÓJ NOWY KATALOG GENERALNY C009 – 2022/2023

DEDYKOWANY, KOMPAKTOWY, PORECZNY.

Bogate portfolio produktów Mitsubishi Materials zostało podzielone na małe katalogi, poświęcone poszczególnym obszarom zastosowań, oferując użytkownikom szybki i łatwy dostęp do potrzebnych informacji o produktach.

Zestaw katalogów dostępny jest w małych, praktycznych rozmiarach i jest podzielony na 5 tomów:

- **NARZĘDZIA TOKARSKIE**
- **WIERTŁA**
- **FREZY MONOLITYCZNE**
- **FREZY SKŁADANE**
- **MPLUS**

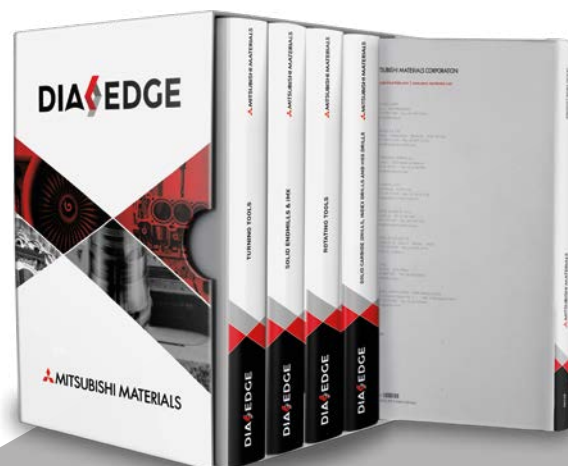

NOWY UKŁAD

ŁATWE KORZYSTANIE

WIĘKSZA ELASTYCZNOŚĆ

PODZIAŁ NA OBSZARY ZASTOSOWAŃ

Sztywny futerał zapewnia potrzebną przestrzeń do przechowywania wszystkich tomów katalogu oraz suplementu z nowymi produktami, który wydawany jest w czasie dwuletniego cyklu obowiązywania katalogu generalnego. Każdy nowy suplement w pełni zastępuje poprzednią wersję suplementu, dzięki czemu każdorazowo można pozbyć się starej wersji.

INFORMACJE:

- Wraz z niniejszą publikacją, wszystkie poprzednie wersje katalogu generalnego i suplementów tracą swoją ważność.
- Suplement "Nowe Produkty" wydawany jest dwa razy do roku: w kwietniu i październiku.
- Nowy katalog generalny może być zamawiany wyłącznie jako zestaw 5 tomów. **Numer zamówieniowy to C009P.**



CYFROWA WERSJA KATALOGU

Aby uzyskać cyfrową wersję katalogu, zeskanuj kod QR lub odwiedź nas na www.mhg-mediastore.net

WIERTŁA



WYDAJNOŚĆ – REDEFINICJA PARAMETRÓW SKRAWANIA

Nowoczesny przemysł wytwórczy podlega bardzo szybkim zmianom, a Mitsubishi pragnie być blisko rynku i klientów.

Dzięki bliskiej współpracy z partnerami i klientami, oferujemy rozwiązania do każdej aplikacji.

Począwszy od wiertel z płytkami wieloostrowymi MVX, o głębokości wiercenia do $6 \times D$, po wiertła do głębokich otworów MPS1 - Mitsubishi Materials oferuje indywidualne rozwiązania dla wszystkich aplikacji wiercenia.

DIA EDGE

TWORZYĆ LEPSZĄ,
PRZYSZŁOŚĆ
WSPÓLNIE Z NASZYM
KLIENTAMI

Prezentujemy DIAEDGE, nową markę naszych narzędzi, która łączy najnowsze technologie, ekscytując wszystkich, którzy z nich korzystają.

Naszym celem jest nie tylko uzyskanie przez klientów wartości dodanej dzięki naszym narzędziom, ale także bliska współpraca z nimi, dzielenie się inspiracjami i podejmowanie wciąż nowych wyzwań.



MITSUBISHI MATERIALS

INDEKS

WIERTŁA



WIERCENIE	M001
CZĘŚCI ZAPASOWE	N001
INFORMACJE TECHNICZNE	P001
INDEKS	1
INFORMACJE OGÓLNE	

PROGRAM PRODUKCYJNY NARZĘDZI DO WIERCENIA - OBJAŚNIENIA

● Sposób organizacji strony w tym rozdziale

① Organizacja według zastosowania wiertła.

FOTOGRAFIA WYROBU

NAZWA WYROBU

TYP WYROBU

TOLERANCJA ŚREDNICY

RODZAJ PRODUKTU

GEOMETRIA

WIERCENIE (WIERTŁA PEŁNOWĘGLIKOWE)

MPS1

Nowa wzmocniona powłoka PVD bazująca na specjalnym karbidzie AlTiN-CrN.
 MPS1 to typ wiertła z podłożną listwą, co umożliwia dodatkową obróbkę.

3-DCDC58 6-DCDC10 10-DCDC16 14-DCDC20

Chłodzenie wewnętrzne

● Typ 1 Typ z chwytem walowym ze szlókową szczyłką
 ● Typ 2 Typ z chwytem walowym
 ● Typ 3 Chwył Whistle-Notch ze szlókową szczyłką
 ● Typ 4 Chwył Whistle-Notch

MPS1—SIL-DIN-CL-RC-L-40C
 MPS1—SIL-DIN-CL-RC-L-40C
 MPS1—SIL-DIN (Whistle notch)

DC (mm)	Dł. całkowita (mm)	Dł. roboczej (mm)	Wymiary (mm)						
			LU	LCF	LH	LF	LP	PC	
3	15,0	19,0	24,0	61,0	61,0	61,0	61,0	61,0	61,0
5	15,0	19,0	24,0	61,0	61,0	61,0	61,0	61,0	61,0
8	20,0	24,0	28,0	65,0	65,0	65,0	65,0	65,0	65,0
10	20,0	24,0	28,0	65,0	65,0	65,0	65,0	65,0	65,0
12	20,0	24,0	28,0	65,0	65,0	65,0	65,0	65,0	65,0
15	20,0	24,0	28,0	65,0	65,0	65,0	65,0	65,0	65,0
20	20,0	24,0	28,0	65,0	65,0	65,0	65,0	65,0	65,0
25	20,0	24,0	28,0	65,0	65,0	65,0	65,0	65,0	65,0
30	20,0	24,0	28,0	65,0	65,0	65,0	65,0	65,0	65,0
35	20,0	24,0	28,0	65,0	65,0	65,0	65,0	65,0	65,0
40	20,0	24,0	28,0	65,0	65,0	65,0	65,0	65,0	65,0

M044 ● Standard magazynowy. □ Niestandardowy, produkowany na specjalne zamówienie.

WIERCENIE (WIERTŁA Z PŁYTKĄ CENTRALNA)

TAW

Falista krawędź skręcająca zapewnia dobre formowanie wióra.
 Kształt umożliwiający precyzyjne mocowanie płytki.
 Łatwa wymiana płytki.

(Zastosowanie uniwersalne)

OPRAWKI

DC (mm)	Dł. całkowita (mm)	Dł. roboczej (mm)	Wymiary (mm)						Dł. całkowita (mm)	Dł. roboczej (mm)	Dł. całkowita (mm)	Dł. roboczej (mm)	
			LU	LCF	LH	LF	LP	PC					
3	58,0	71,4	102,4	158,8	155,0	25	WS304017T	TKY10T	WP74405	MK	KS	18,6	18,6
5	95,0	110,4	137,4	193,4	190,0	25	WS304017T	TKY10T	WP74405	MK	KS	18,7	18,7
8	151,4	165,4	188,4	244,4	241,0	25	WS304017T	TKY10T	WP74405	MK	KS	18,8	18,8
10	151,4	165,4	188,4	244,4	241,0	25	WS304017T	TKY10T	WP74405	MK	KS	18,9	18,9
12	151,4	165,4	188,4	244,4	241,0	25	WS304017T	TKY10T	WP74405	MK	KS	19,0	19,0
15	151,4	165,4	188,4	244,4	241,0	25	WS304017T	TKY10T	WP74405	MK	KS	19,1	19,1
20	151,4	165,4	188,4	244,4	241,0	25	WS304017T	TKY10T	WP74405	MK	KS	19,2	19,2
25	151,4	165,4	188,4	244,4	241,0	25	WS304017T	TKY10T	WP74405	MK	KS	19,3	19,3
30	151,4	165,4	188,4	244,4	241,0	25	WS304017T	TKY10T	WP74405	MK	KS	19,4	19,4
35	151,4	165,4	188,4	244,4	241,0	25	WS304017T	TKY10T	WP74405	MK	KS	19,5	19,5
40	151,4	165,4	188,4	244,4	241,0	25	WS304017T	TKY10T	WP74405	MK	KS	19,6	19,6

Uwaga 1) Wymiary oznaczone (*) dotyczą wiertła z zamontowaną płytką.
 Uwaga 2) Gdy geometria wiertła nie odpowiada wartościom podanym w tabeli (np. inna średnica i długość wiertła), prosimy o skontaktowanie się z naszą firmą.

M150 ● Standard magazynowy. □ Niestandardowy, produkowany na specjalne zamówienie. (Uwaga: w opakowaniu znajduje się 1 płytki)

PROGRAM PRODUKCYJNY podaje średnice, numery zamówieniowe, dostępność, liczbę krawędzi skręcających, wymiary i części pasowe dla wyrobu.

OBJAŚNIENIE SYMBOLI DOSTĘPNOŚCI podane na lewej stronie każdego dwustronicowego opisu.

NARZĘDZIA DO WIERCENIA

SPOSÓB OZNACZANIA WYROBÓW	M002
OBJAŚNIENIA SYMBOLI	M003
WYTYCZNE DOBORU WIERTEŁ	M004

WYTYCZNE DOBORU WIERTEŁ

PEŁNOWĘGLIKOWE

MSE	[Mikrowiertła]	M008
MSP	[Nawiertak]	M011
DLE	[Nawiertaki pełnowęglkowe do nawiercania nakiełków i fazowania]	M012
MINI-MFE	[Wiertła pełnowęglkowe z płaskim czołem]	M018
NEW MINI-DWAE	[Do automatów tokarskich i małych tokarek CNC]	M020
NEW DWAE	[Do automatów tokarskich i małych tokarek CNC]	M021
MINI-MVS	[Wiertła z podwójną łysinką z chłodzeniem wewnętrznym]	M036
MINI-MWS	[Wiertła z łysinką standardową/pojedyńczą i chłodzeniem wewnętrznym]	M040
MPS1	[Wiertła z podwójną łysinką i wiertła super długie]	M044
MPS	[Wiertła z podwójną łysinką i wiertła super długie]	M062
MSL	[Wiertła z łysinką standardową, super długie]	M074
MICRO-MGS	[Mikrowiertła lufowe z chłodzeniem wewnętrznym]	M079
MMS	[Wiertła z chłodzeniem wewnętrznym do stali nierdzewnych]	M082
NEW DSAS	[Do obróbki stopów żaroodpornych]	M096
MNS	[Wiertła z 4 kanałami doprowadzenia chłodziwa, do obróbki aluminium]	M100
MAE/MAS	[Wiertła o podwyższonej dokładności do obróbki aluminium]	M124
MHS	[Wiertła o podwyższonej dokładności do obróbki materiałów twardych]	M130

DO KOMPOZYTÓW CFRP

MCC	[Do obróbki pakietów CFRP na obrabiarkach CNC]	M188
MCA	[Do obróbki pakietów CFRP / aluminium na obrabiarkach CNC]	M189
MCT	[Do obróbki pakietów CFRP / tytan na obrabiarkach CNC]	M190
MCW	[Do wiercenia dokładnych otworów w pakietach CFRP na obrabiarkach CNC]	M191
MCCH	[Do obróbki ręcznej CFRP]	M192
MCAH	[Do obróbki ręcznej pakietów CFRP/ Aluminium]	M193

WIERTŁA Z PŁYTKAMI WIELOOSTRZOWYMI

STAW	[Wiertła z płytką centralną]	M141
TAW	[Wiertła z płytką centralną]	M150
MX	[Wiertła z płytkami wielostrzowymi]	M160
TULEJA MIMOŚRODOWA "JUST FIT"		M172

WIERTŁA HSS

WIERTŁA VIOLET

VAPDS	[Wiertła ze stali szybko tnącej (wykonane metalurgią proszków, bez kobaltu)]	M174
VAPDM	[Wiertła ze stali szybko tnącej (wykonane metalurgią proszków, bez kobaltu)]	M179
VSD	[Wiertła z długim rowkiem wiórowym, ze stali szybko tnącej, do stali nierdzewnych]	M183
VAPDSCB	[Wiertła ze stali szybko tnącej kobaltowej do pogłębiania czołowego]	M185

*Indeks alfabetyczny

M012 DLE
M096 DSAS
M021 DWAE
M172 JFS (TULEJA MIMOŚRODOWA)
M124 MAE
M124 MAS
M189 MCA
M193 MCAH
M188 MCC
M192 MCCH
M190 MCT
M191 MCW

M130 MHS
M079 MICRO-MGS
M020 MINI-DWAE
M018 MINI-MFE
M036 MINI MVS
M040 MINI MWS
M082 MMS
M100 MNS
M062 MPS
M044 MPS1
M008 MSE
M074 MSL

M011 MSP
M160 MVX
M168 MVX (PŁYTKI)
M141 STAW
M144 STAW (PŁYTKI)
M150 TAW
M155 TAW (PŁYTKI)
M179 VAPDM
M174 VAPDS
M185 VAPDSCB
M183 VSD



Prosimy o natychmiastową zmianę wszystkich nadchodzących zamówień, obejmujących pozycje zaznaczone na szaro (MPS, MSL) na serię MPS1. Produkcja serii MPS i MSL jest wygaszana i od marca 2023 zostanie całkowicie zakończona.

SPOSÓB OZNACZANIA WYROBÓW

SPOSÓB OZNACZANIA WIERTEŁ

M
WIERCENIE

MV

S

0300

X

S

Nazwa wiertła	Typ chłodzenia	Średnica	L/D	Typ średnicy chwytu
DLE : WIERTŁA DLE	E : Chłodzenie zewnętrzne	Np.	S : 2D	A : Średnica chwytu równa średnicy wiertła
DSA : WIERTŁA DSAS	S : Chłodzenie wewnętrzne	0050 → ϕ 0.5	M : 3D	B : Średnica chwytu - patrz dane katalogowe
DWA : WIERTŁA DWAE		0300 → ϕ 3.0	L : 5D (Typ MAE / MAS = 6D)	C : Typ z chwytym walcowym
MPS1 : WIERTŁA MPS1			L8C : 8D	S*** : Średnica chwytu
MV : WIERTŁA MVS			L10C : 10D	
MW : WIERTŁA MWS			L12C : 12D	
MF : WIERTŁA MFE			L15C : 15D	
MG : WIERTŁA MGS			L20C : 20D	
MSL : WIERTŁA MSL			L25C : 25D	
MP : WIERTŁA MPS			L30C : 30D	
MA : WIERTŁA MAE/MAS			L40C : 40D	
MS : WIERTŁA MSE			X : 12D	
MM : WIERTŁA MMS			X8DB : 8D	
MN : WIERTŁA MNS			X10DB : 10D	
MH : WIERTŁA MHS			X15DB : 15D	
MC : WIERTŁA MC			X20DB : 20D	
			X25DB : 25D	
			X30DB : 30D	

* Inne.

VA

PD

S

D0050

Nazwa wiertła	Zastosowanie	Długość rowka wiórowego	Średnica
VA : Wiertła o podwyższonej dokładności z powłoką VIOLET (Wysokogatunkowa stal szybko tnąca)	SD : Wiertło cylindryczne uniwersalne	S : Krótki	Np.
V : Wiertła VIOLET	PD : Do obróbki wysokodokładnej	M : Średni	D0300 → ϕ 3.0
			D0050 → ϕ 0.5

* Inne.



Prosimy o natychmiastową zmianę wszystkich nadchodzących zamówień, obejmujących pozycje zaznaczone na szaro (MPS, MSL) na serię MPS1. Produkcja serii MPS i MSL jest wygaszana i od marca 2023 zostanie całkowicie zakończona.

OBJAŚNIENIA SYMBOLI

Materiał narzędzia



Węgiel o strukturze ultra drobnoziarnistej
Materiałem podłoża jest węgiel o strukturze drobnoziarnistej.



Wysokostopowa stal szybko tnąca (HSS)
Materiałem podłoża jest wysokostopowa stal szybko tnąca.



Stal szybko tnąca kobaltowa
Materiałem podłoża jest stal szybko tnąca kobaltowa.



Stal szybko tnąca
Materiałem podłoża jest stal szybko tnąca.

Korekcja ścina



Korekcja ścina – szlif krzyżowy (X)
Szlif krzyżowy jest jednym z rodzajów korekcji ostrza wiertła.



Korekcja ścina – szlif krzyżowy (Z)
Szlif krzyżowy jest jednym z rodzajów korekcji ostrza wiertła.



Korekcja ścina – szlif krzyżowy (XR)
Szlif krzyżowy (XR) jest jednym z rodzajów korekcji ostrza wiertła.



Korekcja ścina – szlif krzyżowy (N)
Szlif krzyżowy (N) jest jednym z rodzajów korekcji ostrza wiertła.

Tolerancja



Tolerancja średnicy wiertła



Tolerancja średnicy chwytu

Kanał chłodziwa



Z kanałem chłodziwa

Zakres zastosowań pod względem materiału obrabianego

Zalecane



Nie Zalecane



Rodzaj powłoki



Powłoka MIRACLE

Konwencjonalna powłoka MIRACLE (Al,Ti)N.
Zalecana również do obróbki na sucho (bez chłodziwa).



Powłoka PVD

DP102A to gatunek węgla spiekane pokrywany metodą PVD (fizycznie), przeznaczony do wiertel o małej średnicy, o znacznie zwiększonej odporności na ścieranie.



Powłoka PVD

Wykazuje doskonałą odporność na ścieranie podczas obróbki wielu gatunków stali, żeliw i stopów aluminium.



Powłoka PVD

Węgiel spiekany o strukturze ultradrobnoziarnistej, do obróbki stali nierdzewnych; powłoka PVD o doskonałej odporności cieplnej, zapewnia doskonały poślizg



Powłoka PVD

DP9020 zapewnia zarówno wysoką odporność na ścieranie i złamanie, dłuższą trwałość wiertła.



Powłoka VIOLET

Powłoka nowej generacji odpowiednia do wszystkich rodzajów materiałów.



Powłoka diamentowa CVD

Unikatowa, drobnoziarnista, wielowarstwowa powłoka diamentowa w technologii kontrolowanego wzrostu kryształów, zapewniająca znacznie wyższą odporność na ścieranie i gładkość.

Kąt wierzchołkowy









Kąt wierzchołkowy

Określa kąt wierzchołkowy wiertła.

WYTYCZNE DOBORU WIERTEŁ

WIERCENIE

M

Materiał narzędzia	Zakres Wymiarów	Głębokość otworu (L/D)	Oznaczenie wyrobu	Chłodzenie	Rodzaj powłoki	Materiał przedmiotu obrabianego						Kształt	Numer strony	
						P	M	K	N	S	H		Wymiary	Parametry skrawania
						Stal węglowa, Stal stopowa	Stal nierdzewna	Żeliwo	Stopy lekkie	Stop żaroodporny	Stal hartowana			
Wiertła Pełnowęglkowe	φ0.1 - φ0.99	5 - 12	MSE	Zewnętrzne	VP	○	○	○	○	○	○		M008	M009
	MSP = Nawiertak do wiertła MSE													
	φ1.0 - φ16.0	-	DLE	Zewnętrzne	DP1 DP1A	○	○	○					M012	M016
	SIG=60°, 90°, 120°, 145°													
	φ0.75 - φ2.95	2	MINI-MFE	Zewnętrzne	DP1A	○	○	○	○				M018	M019
	φ1.0 - φ2.9	2,4	MINI-DWAE	Zewnętrzne	DP1A	○	○	○					M020	M027
	φ3.0 - φ14.0	2,4	DWAE	Zewnętrzne	DP1A	○	○	○					M021	M027
	φ1.0 - φ2.9	*2 - 30	MINI-MVS	Wewnętrzne	DP1	○	○	○	○	○			M036	M038
	φ0.5 - φ0.99	1 - 12	MINI-MWS	Wewnętrzne	VP	○	○	○	○	○			M040	M042
	φ3.0 - φ20.0	3 - 40	MPS1	Wewnętrzne	DP1	○	○	○					M044	M059
	MPS1-xxxx-PC=Nawiertak do wiertła MPS1													
	φ3.0 - φ20.0	3 - 40	MPS	Wewnętrzne	VP	○	○	○		○			M062	M077
	φ3.0 - φ14.0	20 - 30	MSL	Wewnętrzne	VP	○	○	○		○			M074	M077
	φ0.95 - φ12.0	1 - 30	MHS	Wewnętrzne	VP	○	○			○	○		M130	M138
φ3.0 - φ20.0	3, 5	MMS	Wewnętrzne	DP7		○						M082	M094	
φ3.0 - φ12.0	3	DSAS	Wewnętrzne	DP9					○			M096	M099	
φ0.7 - φ3.0	-80	MICRO-MGS	Wewnętrzne	-	○	○	○	○				M079	M080	

*2=Wiertło pilotowe. Tolerancja: +0.014, głębokość otworu: DCx2.



Prosimy o natychmiastową zmianę wszystkich nadchodzących zamówień, obejmujących pozycje zaznaczone na szaro (MPS, MSL) na serię MPS1. Produkcja serii MPS i MSL jest wygaszana i od marca 2023 zostanie całkowicie zakończona.

Materiał narzędzia	Zakres Wymiarów	Głębokość otworu (L/D)	Oznaczenie wyrobu	Chłodzenie	Rodzaj powłoki	Materiał przedmiotu obrabianego						Kształt oprawki	Numer strony						
						P	M	K	N	S	H		Wymiary	Parametry skrawania					
						Stal węglowa, Stal stopowa	Stal nierdzewna	Żeliwo	Stopy lekkie	Stop żaroodporny	Stal hartowana								
Wiertła Pełnowęglkowe	φ3.0 – φ16.0	3	MAE	Zewnętrzne	–			○	○										
	φ3.0 – φ16.0	3, 6	MAS	Wewnętrzne	–			○	○										
	φ3.0 – φ20.0	3–30	MNS	Wewnętrzne	–				○										
	φ4.76 – φ11.14	3	MCC	Zewnętrzne		Do Kompozytów CFRP							M188	M188					
	φ6.38 – φ9.55	5	MCA	Wewnętrzne		Do Kompozytów CFRP + Al							M189	M189					
	φ6.38 – φ9.55	5	MCT	Wewnętrzne	–	Do Kompozytów CFRP + Ti							M190	M190					
	φ6.38 – φ9.55	5	MCW	Wewnętrzne		Do wiercenia dokładnych otworów w pakietach CFRP							M191	M191					
	φ2.5 – φ9.55	2–15	MCCH	Zewnętrzne	–	Do Kompozytów CFRP							M192	Narzędzie ręczne					
	φ2.5 – φ9.55	3–15	MCAH	Zewnętrzne	–	Do Kompozytów CFRP + Al							M193	Narzędzie ręczne					
Stal szybko tnąca	φ0.5 – φ13.0	2–3	VAPDS	Zewnętrzne		○	○	○											
	φ0.5 – φ32.0	3–6	VAPDM	Zewnętrzne		○	○	○											
	φ0.5 – φ13.0	3–6	VSD	Zewnętrzne		○	○												
	φ2.0 – φ32.0	2–3	VAPDSCB	Zewnętrzne		○	○	○	○										
Wiertła z płytkami wielostronowymi/wymienialnymi	φ10.0 – φ18.4	1.5–8	STAW	Wewnętrzne		○	○	○											
	φ18.5 – φ30.4	3–8	TAW	Wewnętrzne		○	○	○											
	φ17.0 – φ63.0	2–6	MVX	Wewnętrzne	–	○	○	○	○		○								

○ : Pierwszy wybór / ○ : Drugi wybór

TYPOSZEREGI WIERTEL

Pierwszy wybór

P M K N S H

Drugi wybór

P M K N S H

■ WIERTŁA PEŁNOWĘGLIKOWE

MPS (Typ z podwójną łysinką)

P M K S

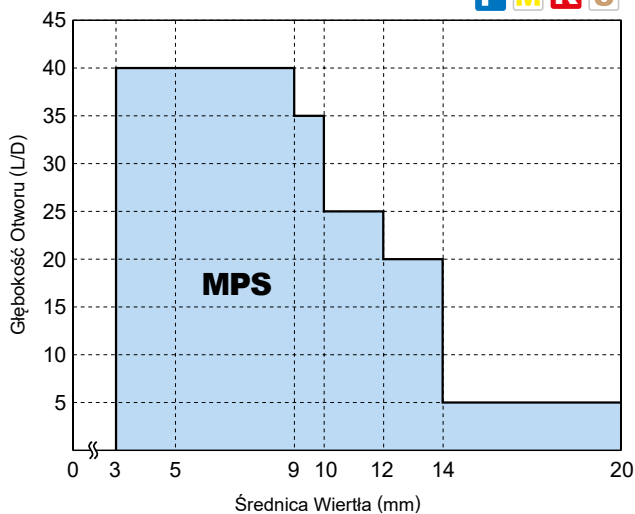

MPS1 (Typ z podwójną łysinką)

P M K

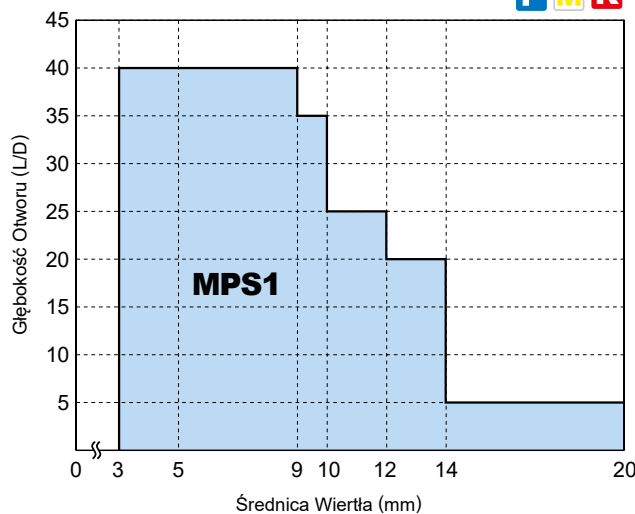

MICRO-MGS

P M K N

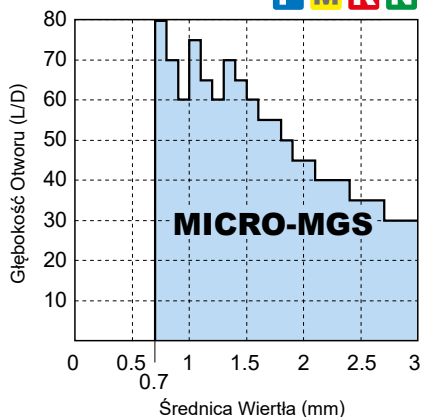

MINI-MVS, MINI-MWS

P M K N S

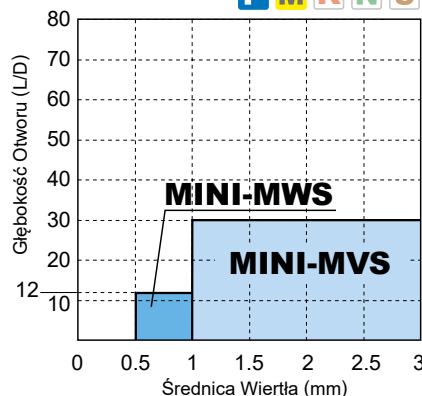

MINI-DWAE, DWAE

P M K

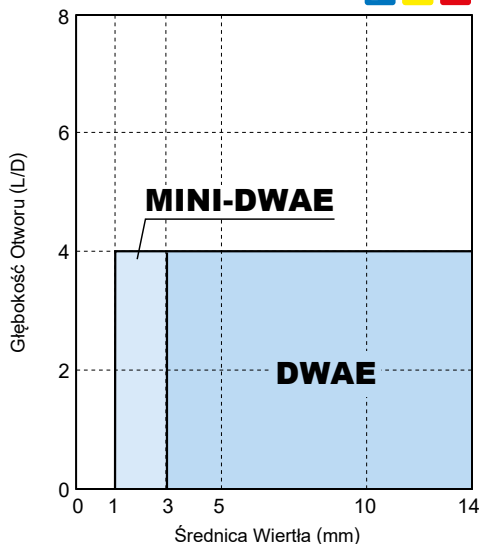

MINI-MFE

P M K N

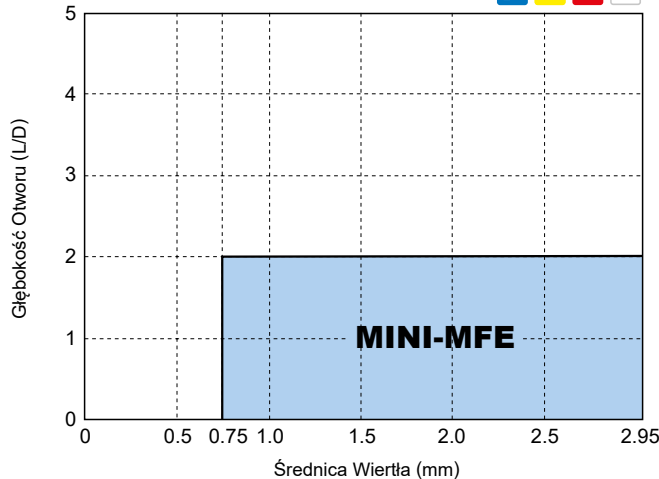

Pierwszy wybór

P M K N S H

Drugi wybór

P M K N S H

■ WIERTŁA PEŁNOWĘGLIKOWE

MMS (Stale nierdzewne)

M

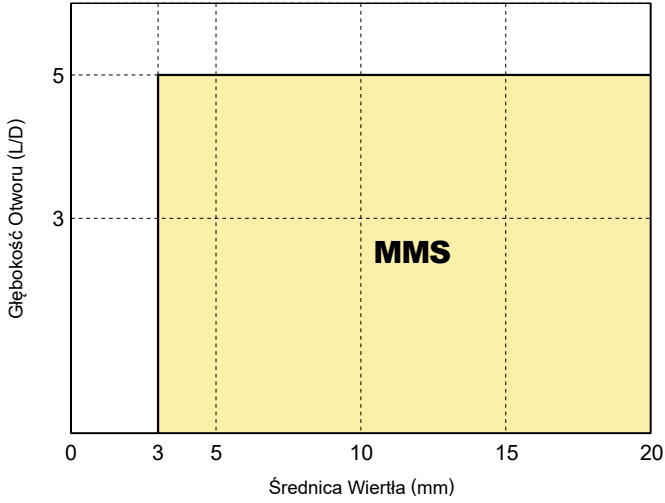

DSAS (Do obróbki stopów żaroodpornych)

S

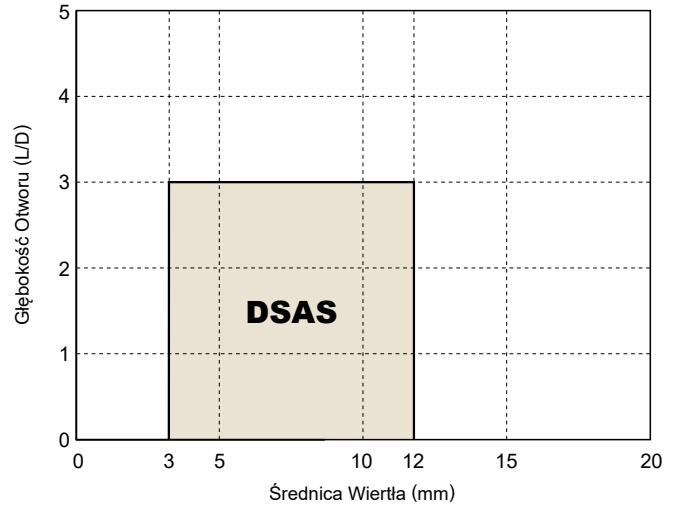

M
WIERCENIE

MNS (Do obróbki stopów aluminium)

N

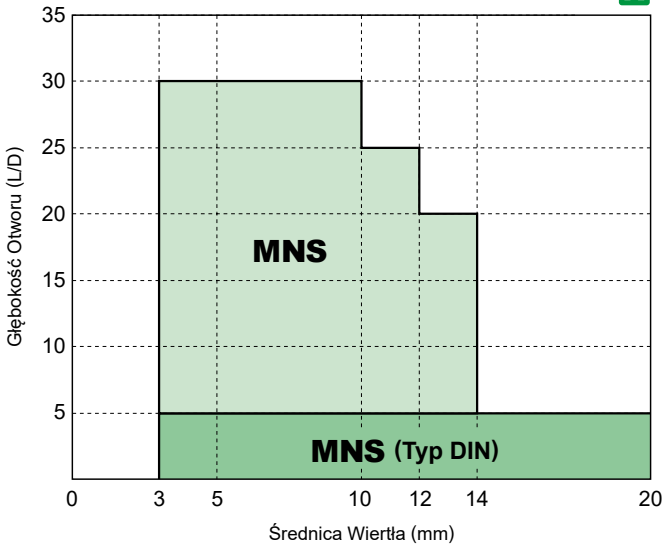

MHS (Do obróbki form i matryc)

P M S H

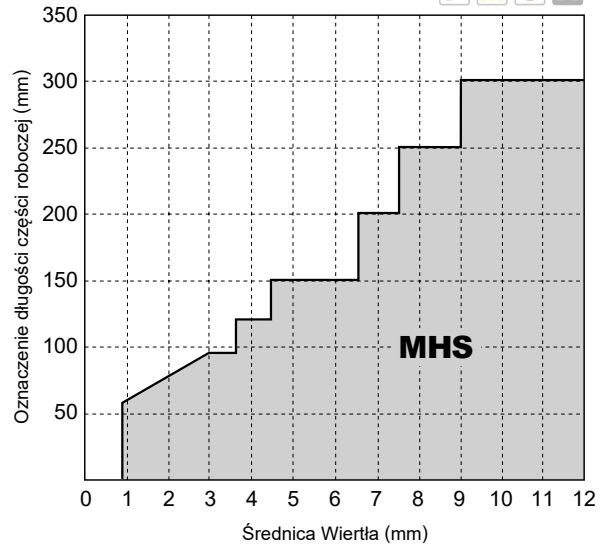

■ WIERTŁA Z PŁYTKĄ CENTRALNĄ

S-TAW, TAW

P M K

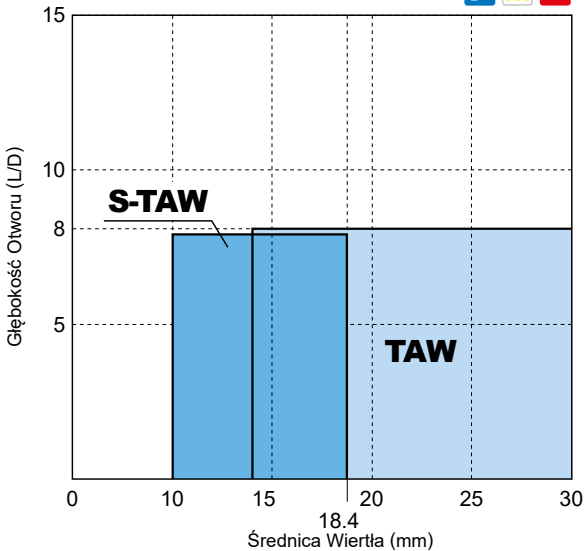

MVX

P M K N H

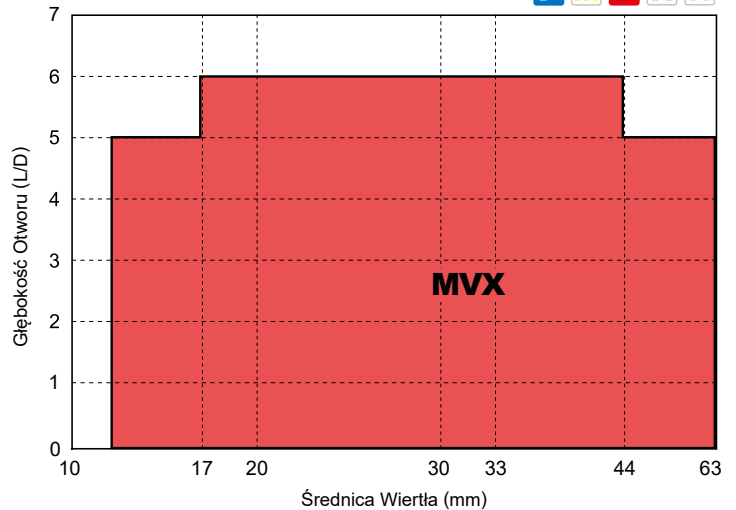

WIERCENIE (WIERTŁA PEŁNOWĘGLIKOWE)

MSE

- Szeroki rowek wiórowy, zapobiegający zakleszczeniu się wióra.
- Stabilne wiercenie otworów o małej średnicy.



WĘGLIKI
SPIEKANE



Chłodzenie zewnętrzne

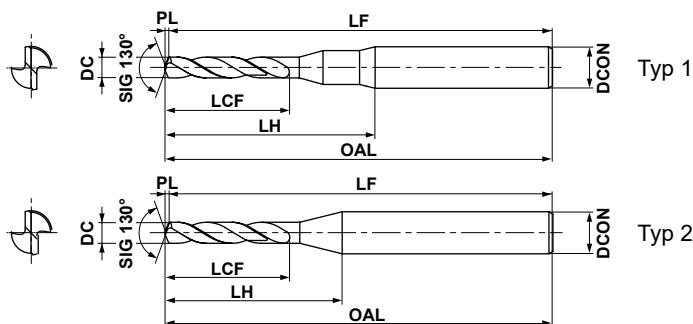

M

WIERCENIE

	$0.10 \leq DC \leq 0.99$
	0 -0.009
	DCON=3
	0 -0.006

● Wiertła MSE można stosować z oprawkami termokurczliwymi.

DC (mm)	VP20MF	VP15TF	Numer zamówieniowy	Wymiary (mm)						Typ
				LCF	LH	OAL	LF	PL	DCON	
0.10	●		MSE0010SB	1.2	9.7	38.0	38	0.02	3	1
0.11	●		MSE0011SB	1.2	9.7	38.0	38	0.03	3	1
0.12	●		MSE0012SB	1.4	9.7	38.0	38	0.03	3	1
0.13	●		MSE0013SB	1.4	9.7	38.0	38	0.03	3	1
0.14	●		MSE0014SB	2.0	9.7	38.0	38	0.03	3	1
0.15	●		MSE0015SB	2.0	9.7	38.0	38	0.03	3	1
0.16	●		MSE0016SB	2.0	9.7	38.0	38	0.04	3	1
0.17	●		MSE0017SB	2.0	9.7	38.0	38	0.04	3	1
0.18	●		MSE0018SB	2.0	9.7	38.0	38	0.04	3	1
0.19	●		MSE0019SB	2.0	9.7	38.0	38	0.04	3	1
0.20	●		MSE0020SB	2.6	9.8	38.1	38	0.05	3	1
0.21	●		MSE0021SB	2.6	9.8	38.1	38	0.05	3	1
0.22	●		MSE0022SB	2.6	9.8	38.1	38	0.05	3	1
0.23	●		MSE0023SB	2.6	9.8	38.1	38	0.05	3	1
0.24	●		MSE0024SB	3.1	9.8	38.1	38	0.06	3	1
0.25	●		MSE0025SB	3.1	9.8	38.1	38	0.06	3	1
0.26	●		MSE0026SB	3.1	9.8	38.1	38	0.06	3	1
0.27	●		MSE0027SB	3.1	9.8	38.1	38	0.06	3	1
0.28	●		MSE0028SB	3.1	9.8	38.1	38	0.07	3	1
0.29	●		MSE0029SB	3.1	9.8	38.1	38	0.07	3	1
0.30	●		MSE0030SB	5.1	10.3	38.1	38	0.07	3	2
0.31	●		MSE0031SB	5.1	10.3	38.1	38	0.07	3	2
0.32	●		MSE0032SB	5.1	10.3	38.1	38	0.07	3	2
0.33	●		MSE0033SB	5.1	10.3	38.1	38	0.08	3	2
0.34	●		MSE0034SB	6.1	11.3	38.1	38	0.08	3	2
0.35	●		MSE0035SB	6.1	11.2	38.1	38	0.08	3	2
0.36	●		MSE0036SB	6.1	11.2	38.1	38	0.08	3	2
0.37	●		MSE0037SB	6.1	11.2	38.1	38	0.09	3	2
0.38	●		MSE0038SB	6.1	11.2	38.1	38	0.09	3	2
0.39	●		MSE0039SB	6.1	11.2	38.1	38	0.09	3	2
0.40	●		MSE0040SB	7.1	12.2	38.1	38	0.09	3	2
0.41	●		MSE0041SB	7.1	12.1	38.1	38	0.10	3	2
0.42	●		MSE0042SB	7.1	12.1	38.1	38	0.10	3	2
0.43	●		MSE0043SB	7.1	12.1	38.1	38	0.10	3	2

DC (mm)	VP20MF	VP15TF	Numer zamówieniowy	Wymiary (mm)						Typ
				LCF	LH	OAL	LF	PL	DCON	
0.44	●		MSE0044SB	7.1	12.1	38.1	38	0.10	3	2
0.45	●		MSE0045SB	7.1	12.1	38.1	38	0.10	3	2
0.46	●		MSE0046SB	7.1	12.0	38.1	38	0.11	3	2
0.47	●		MSE0047SB	7.1	12.0	38.1	38	0.11	3	2
0.48	●		MSE0048SB	7.1	12.0	38.1	38	0.11	3	2
0.49	●		MSE0049SB	7.1	12.0	38.1	38	0.11	3	2
0.50	●		MSE0050SB	7.1	12.0	38.1	38	0.12	3	2
0.51	●		MSE0051SB	7.1	11.9	38.1	38	0.12	3	2
0.52	●		MSE0052SB	7.1	11.9	38.1	38	0.12	3	2
0.53	●		MSE0053SB	7.1	11.9	38.1	38	0.12	3	2
0.54	●		MSE0054SB	7.1	11.9	38.1	38	0.13	3	2
0.55	●		MSE0055SB	7.1	11.9	38.1	38	0.13	3	2
0.56	●		MSE0056SB	7.1	11.9	38.1	38	0.13	3	2
0.57	●		MSE0057SB	7.1	11.8	38.1	38	0.13	3	2
0.58	●		MSE0058SB	7.1	11.8	38.1	38	0.14	3	2
0.59	●		MSE0059SB	7.1	11.8	38.1	38	0.14	3	2
0.60	●		MSE0060SB	7.1	11.8	38.1	38	0.14	3	2
0.61	●		MSE0061SB	7.1	11.8	38.1	38	0.14	3	2
0.62	●		MSE0062SB	7.1	11.7	38.1	38	0.14	3	2
0.63	●		MSE0063SB	7.2	11.8	38.2	38	0.15	3	2
0.64	●		MSE0064SB	7.2	11.8	38.2	38	0.15	3	2
0.65	●		MSE0065SB	7.2	11.8	38.2	38	0.15	3	2
0.66	●		MSE0066SB	7.2	11.8	38.2	38	0.15	3	2
0.67	●		MSE0067SB	7.2	11.7	38.2	38	0.16	3	2
0.68	●		MSE0068SB	7.2	11.7	38.2	38	0.16	3	2
0.69	●		MSE0069SB	7.2	11.7	38.2	38	0.16	3	2
0.70	●		MSE0070SB	8.2	12.7	38.2	38	0.16	3	2
0.71	●		MSE0071SB	8.2	12.7	38.2	38	0.17	3	2
0.72	●		MSE0072SB	8.2	12.7	38.2	38	0.17	3	2
0.73	●		MSE0073SB	8.2	12.6	38.2	38	0.17	3	2
0.74	●		MSE0074SB	8.2	12.6	38.2	38	0.17	3	2
0.75	●		MSE0075SB	8.2	12.6	38.2	38	0.17	3	2
0.76	●		MSE0076SB	8.2	12.6	38.2	38	0.18	3	2
0.77	●		MSE0077SB	8.2	12.6	38.2	38	0.18	3	2

Uwaga 1) Gdy geometria wiertła nie odpowiada wartościom podanym w tabeli (np. inna średnica i długość wiertła), prosimy o skontaktowanie się z naszą firmą.

● : Standard magazynowy. ★ : Na specjalne zamówienie z magazynu w Japonii.

DC (mm)	VP20MF	VP15TF	Numer zamówieniowy	Wymiary (mm)						Typ
				LCF	LH	OAL	LF	PL	DCON	
0.78	●	●	MSE0078SB	8.2	12.5	38.2	38	0.18	3	2
0.79	●	●	MSE0079SB	8.2	12.5	38.2	38	0.18	3	2
0.80	●	●	MSE0080SB	10.2	14.5	38.2	38	0.19	3	2
0.81	●	●	MSE0081SB	10.2	14.5	38.2	38	0.19	3	2
0.82	●	●	MSE0082SB	10.2	14.5	38.2	38	0.19	3	2
0.83	●	●	MSE0083SB	10.2	14.5	38.2	38	0.19	3	2
0.84	●	●	MSE0084SB	10.2	14.4	38.2	38	0.20	3	2
0.85	●	●	MSE0085SB	10.2	14.4	38.2	38	0.20	3	2
0.86	●	●	MSE0086SB	10.2	14.4	38.2	38	0.20	3	2
0.87	●	●	MSE0087SB	10.2	14.4	38.2	38	0.20	3	2
0.88	●	●	MSE0088SB	10.2	14.4	38.2	38	0.21	3	2

DC (mm)	VP20MF	VP15TF	Numer zamówieniowy	Wymiary (mm)						Typ
				LCF	LH	OAL	LF	PL	DCON	
0.89	●	●	MSE0089SB	10.2	14.3	38.2	38	0.21	3	2
0.90	●	●	MSE0090SB	10.2	14.3	38.2	38	0.21	3	2
0.91	●	●	MSE0091SB	10.2	14.3	38.2	38	0.21	3	2
0.92	●	●	MSE0092SB	10.2	14.3	38.2	38	0.21	3	2
0.93	●	●	MSE0093SB	10.2	14.3	38.2	38	0.22	3	2
0.94	●	●	MSE0094SB	10.2	14.2	38.2	38	0.22	3	2
0.95	●	●	MSE0095SB	10.2	14.2	38.2	38	0.22	3	2
0.96	●	●	MSE0096SB	10.2	14.2	38.2	38	0.22	3	2
0.97	●	●	MSE0097SB	10.2	14.2	38.2	38	0.23	3	2
0.98	●	●	MSE0098SB	10.2	14.2	38.2	38	0.23	3	2
0.99	●	●	MSE0099SB	10.2	14.2	38.2	38	0.23	3	2

ZALECANE PARAMETRY SKRAWANIA

Materiał przedmiotu obrabianego	P										
	Stal konstrukcyjna (≤180HB) Ck10						Stal węglowa, Stal stopowa (180–280HB) Ck45, 41CrMo4				
Średnica wiertła DC (mm)	Prędkość skrawania (m/min)	Obroty (min ⁻¹)	Posuw (min. – maks.) (mm/obr.)	Odległość po jakiej należy przetrwać wiercenie "odwirować" narzędzie (mm)	Posuw stołu (mm/min)	Prędkość skrawania (m/min)	Obroty (min ⁻¹)	Posuw (min. – maks.) (mm/obr.)	Odległość po jakiej należy przetrwać wiercenie "odwirować" narzędzie (mm)	Posuw stołu (mm/min)	
0.10	6	20000	0.002 (0.001–0.003)	0.02	40	6	20000	0.002 (0.001–0.003)	0.02	40	
0.12	8	20000	0.002 (0.001–0.003)	0.02	40	8	20000	0.002 (0.001–0.003)	0.02	40	
0.16	10	20000	0.002 (0.001–0.003)	0.02	40	10	20000	0.002 (0.001–0.003)	0.02	40	
0.20	13	20000	0.003 (0.002–0.004)	0.04	60	13	20000	0.003 (0.002–0.004)	0.04	60	
0.25	16	20000	0.003 (0.002–0.004)	0.04	60	16	20000	0.003 (0.002–0.004)	0.04	60	
0.32	20	20000	0.004 (0.003–0.005)	0.05	80	20	20000	0.004 (0.003–0.005)	0.05	80	
0.40	25	20000	0.004 (0.003–0.005)	0.05	80	25	20000	0.004 (0.003–0.005)	0.05	80	
0.50	31	20000	0.006 (0.005–0.007)	0.10	120	31	20000	0.006 (0.005–0.007)	0.10	120	
0.63	40	20000	0.008 (0.006–0.010)	0.10	160	40	20000	0.008 (0.006–0.010)	0.10	160	
0.80	50	20000	0.020 (0.015–0.025)	0.30	400	50	20000	0.015 (0.012–0.018)	0.30	300	
0.99	62	20000	0.040 (0.030–0.050)	0.30	800	62	20000	0.020 (0.015–0.025)	0.30	400	

Materiał przedmiotu obrabianego	P										
	Stal węglowa, Stal stopowa (280–350HB) 36CrNiMo4						Stal hartowana (35–45HRC) X36CrMo17				
Średnica wiertła DC (mm)	Prędkość skrawania (m/min)	Obroty (min ⁻¹)	Posuw (min. – maks.) (mm/obr.)	Odległość po jakiej należy przetrwać wiercenie "odwirować" narzędzie (mm)	Posuw stołu (mm/min)	Prędkość skrawania (m/min)	Obroty (min ⁻¹)	Posuw (min. – maks.) (mm/obr.)	Odległość po jakiej należy przetrwać wiercenie "odwirować" narzędzie (mm)	Posuw stołu (mm/min)	
0.10	6	20000	0.002 (0.001–0.003)	0.02	40	6	20000	0.002 (0.001–0.003)	0.02	40	
0.12	8	20000	0.002 (0.001–0.003)	0.02	40	8	20000	0.002 (0.001–0.003)	0.02	40	
0.16	10	20000	0.002 (0.001–0.003)	0.02	40	10	20000	0.002 (0.001–0.003)	0.02	40	
0.20	13	20000	0.003 (0.002–0.004)	0.04	60	13	20000	0.003 (0.002–0.004)	0.04	60	
0.25	16	20000	0.003 (0.002–0.004)	0.04	60	16	20000	0.003 (0.002–0.004)	0.04	60	
0.32	20	20000	0.004 (0.003–0.005)	0.05	80	20	20000	0.004 (0.003–0.005)	0.05	80	
0.40	25	20000	0.004 (0.003–0.005)	0.05	80	25	20000	0.004 (0.003–0.005)	0.05	80	
0.50	31	20000	0.006 (0.005–0.007)	0.10	120	31	20000	0.006 (0.005–0.007)	0.10	120	
0.63	40	20000	0.008 (0.006–0.010)	0.10	160	40	20000	0.008 (0.006–0.010)	0.10	160	
0.80	50	20000	0.015 (0.012–0.018)	0.30	300	50	20000	0.015 (0.012–0.018)	0.30	300	
0.99	62	20000	0.020 (0.015–0.025)	0.30	400	62	20000	0.020 (0.015–0.025)	0.30	400	

Uwaga 1) Wierząc otwory o średnicy do $\phi 0.3$ mm zaleca się użycie nawiertaka.

Uwaga 2) Dostosować parametry skrawania do sztywności obrabiarki i przedmiotu obrabianego.

Uwaga 3) Podczas wiercenia otworów o głębokości powyżej DCx5 należy zmniejszyć podaną wyżej odległość po jakiej należy przetrwać wiercenie i "odwirować" narzędzie.

Uwaga 4) Przy podanych wyżej parametrach skrawania zalecane jest użycia chłodziwa wodorozcieńczalnego (rozcieńczonego w stosunku 1:20). W razie użycia emulsji lub mgły olejowej zmniejszyć obroty wrzeciona.

Uwaga 5) W powyższych tabelach kreska "–" w kolumnie dotyczącej danego materiału oznacza, że wiercenie z chłodzeniem zewnętrznym jest niezalecane.

WIERCENIE (WIERTŁA PEŁNOWĘGLIKOWE)

- Szeroki rowek wiórowy, zapobiegający zakleszczaniu się wióra.
- Stabilne wiercenie otworów o małej średnicy.

MSE

WĘGLIKI
SPIEKANE

ZALECANE PARAMETRY SKRAWANIA

M
WIERCENIE

Materiał przedmiotu obrabianego	M					K					
	Średnica wiertła DC (mm)	Prędkość skrawania (m/min)	Obroty (min ⁻¹)	Posuw (min. – maks.) (mm/obr.)	Odległość po jakiej należy przerwać wiercenie "odwirować" narzędzie (mm)	Posuw stołu (mm/min)	Prędkość skrawania (m/min)	Obroty (min ⁻¹)	Posuw (min. – maks.) (mm/obr.)	Odległość po jakiej należy przerwać wiercenie "odwirować" narzędzie (mm)	Posuw stołu (mm/min)
Austenityczna stal nierdzewna (≤200HB) X5CrNi1810, X5CrNiMo17-12-2											
Żeliwo szare (≤350MPa) GG30											
0.10	6	20000	20000	0.002 (0.001–0.003)	0.02	40	6	20000	0.002 (0.001–0.003)	0.02	40
0.12	8	20000	20000	0.002 (0.001–0.003)	0.02	40	8	20000	0.002 (0.001–0.003)	0.02	40
0.16	10	20000	20000	0.002 (0.001–0.003)	0.02	40	10	20000	0.002 (0.001–0.003)	0.02	40
0.20	11	18000	18000	0.003 (0.002–0.004)	0.04	54	13	20000	0.003 (0.002–0.004)	0.04	60
0.25	14	18000	18000	0.003 (0.002–0.004)	0.04	54	16	20000	0.003 (0.002–0.004)	0.04	60
0.32	15	15000	15000	0.004 (0.003–0.005)	0.05	60	20	20000	0.004 (0.003–0.005)	0.05	80
0.40	19	15000	15000	0.004 (0.003–0.005)	0.05	60	25	20000	0.004 (0.003–0.005)	0.05	80
0.50	16	10000	10000	0.006 (0.005–0.007)	0.10	60	31	20000	0.006 (0.005–0.007)	0.10	120
0.63	20	10000	10000	0.008 (0.006–0.010)	0.10	80	40	20000	0.008 (0.006–0.010)	0.10	160
0.80	15	6000	6000	0.015 (0.012–0.018)	0.20	90	50	20000	0.020 (0.015–0.025)	0.30	400
0.99	19	6000	6000	0.020 (0.015–0.025)	0.20	120	62	20000	0.040 (0.030–0.050)	0.30	800

Materiał przedmiotu obrabianego	N					S					
	Średnica wiertła DC (mm)	Prędkość skrawania (m/min)	Obroty (min ⁻¹)	Posuw (min. – maks.) (mm/obr.)	Odległość po jakiej należy przerwać wiercenie "odwirować" narzędzie (mm)	Posuw stołu (mm/min)	Prędkość skrawania (m/min)	Obroty (min ⁻¹)	Posuw (min. – maks.) (mm/obr.)	Odległość po jakiej należy przerwać wiercenie "odwirować" narzędzie (mm)	Posuw stołu (mm/min)
Stopy aluminium (Si<5%)											
Stop żaroodporny Inconel718											
0.10	6	20000	20000	0.002 (0.001–0.003)	0.05	40	2	7000	0.001 (0.0005–0.001)	0.02	7
0.12	8	20000	20000	0.003 (0.002–0.004)	0.05	60	3	7000	0.001 (0.0005–0.001)	0.02	7
0.16	10	20000	20000	0.004 (0.003–0.005)	0.05	80	4	7000	0.001 (0.0005–0.001)	0.02	7
0.20	13	20000	20000	0.006 (0.005–0.007)	0.10	120	3	5000	0.002 (0.001–0.002)	0.04	10
0.25	16	20000	20000	0.008 (0.006–0.010)	0.10	160	4	5000	0.002 (0.001–0.002)	0.04	10
0.32	20	20000	20000	0.010 (0.008–0.012)	0.30	200	4	4000	0.002 (0.001–0.002)	0.05	8
0.40	25	20000	20000	0.020 (0.015–0.025)	0.30	400	5	4000	0.002 (0.001–0.002)	0.05	8
0.50	31	20000	20000	0.030 (0.025–0.035)	0.50	600	5	3000	0.003 (0.001–0.003)	0.10	9
0.63	40	20000	20000	0.040 (0.035–0.045)	0.50	800	6	3000	0.004 (0.002–0.004)	0.10	12
0.80	50	20000	20000	0.050 (0.045–0.055)	0.80	1000	5	1800	0.006 (0.004–0.006)	0.20	10.8
0.99	62	20000	20000	0.060 (0.055–0.065)	0.80	1200	6	1800	0.010 (0.008–0.010)	0.20	18

Uwaga 1) Wierząc otwory o średnicy do $\phi 0.3\text{mm}$ zaleca się użycie nawiertaka.

Uwaga 2) Dostosować parametry skrawania do sztywności obrabiarki i przedmiotu obrabianego.

Uwaga 3) Podczas wiercenia otworów o głębokości powyżej DCx5 należy zmniejszyć podaną wyżej odległość po jakiej należy przerwać wiercenie i "odwirować" narzędzie.

Uwaga 4) Przy podanych wyżej parametrach skrawania zalecane jest użycia chłodziwa wodorozcieńczalnego (rozcieńczonego w stosunku 1:20). W razie użycia emulsji lub mgły olejowej zmniejszyć obroty wrzeciona.

Uwaga 5) W powyższych tabelach kreska "–" w kolumnie dotyczącej danego materiału oznacza, że wiercenie z chłodzeniem zewnętrznym jest niezalecane.

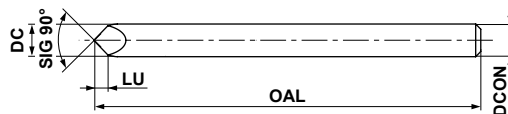

M

WIERCENIE

Numer zamówieniowy	Gatunek	Dostępność	Wymiary (mm)				Zakres średnic (mm)
			DC	LU	OAL	DCON	
MSP0300SB	VP15TF	●	3.0	1.5	38.0	3.0	0.1–3.0

ZALECANE PARAMETRY SKRAWANIA

Zakres średnic otworów (mm)	Obroty (min ⁻¹)	Posuw (min.–maks.) (mm/obr.)	Posuw stołu (mm/min)
0.1–3.0	10000	0.0005 (0.00025–0.001)	5

WIERCENIE (WIERTŁA PEŁNOWĘGLIKOWE)

DLE

Wiodąca seria nawiertaków



WĘGLIKI
SPIEKANE



Chłodzenie zewnętrzne

■ Kąt wierzchołkowy (SIG) 60°, 90°

M

WIERCENIE

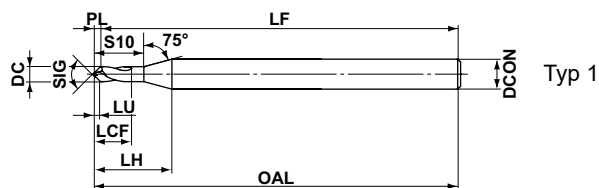

Typ 1

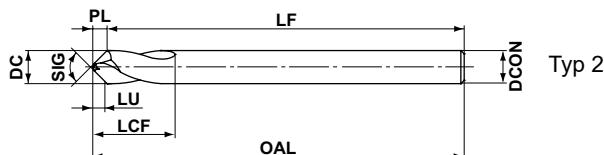

Typ 2

■ Kąt wierzchołkowy (SIG) 120°, 145°

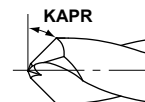

DCON=3	3 < DCON ≤ 6	6 < DCON ≤ 10	10 < DCON ≤ 16
$\begin{matrix} 0 \\ -0.010 \end{matrix}$	$\begin{matrix} 0 \\ -0.012 \end{matrix}$	$\begin{matrix} 0 \\ -0.015 \end{matrix}$	$\begin{matrix} 0 \\ -0.018 \end{matrix}$

DC (mm)	SIG	DP1020	DP102A	Numer zamówieniowy	Wymiary (mm)								Typ	
					LU	LCF	LH	S10	OAL	LF	PL	KAPR		DCON
NEW 3.0	60°	●		DLE0300S030P060	2.0	9	—	—	45	42.9	2.1	60°	3	2
NEW 4.0	60°	●		DLE0400S040P060	2.7	12	—	—	50	47.2	2.8	60°	4	2
NEW 5.0	60°	●		DLE0500S050P060	3.4	14	—	—	60	56.5	3.5	60°	5	2
NEW 6.0	60°	●		DLE0600S060P060	4.0	15	—	—	66	61.8	4.2	60°	6	2
NEW 7.0	60°	●		DLE0700S070P060	4.7	18	—	—	74	69.1	4.9	60°	7	2
NEW 8.0	60°	●		DLE0800S080P060	5.4	20	—	—	74	68.4	5.6	60°	8	2
NEW 10.0	60°	●		DLE1000S100P060	6.8	24	—	—	84	77.0	7.0	60°	10	2
NEW 12.0	60°	●		DLE1200S120P060	8.1	28	—	—	95	86.6	8.4	60°	12	2
NEW 1.0	90°	●		DLE0100S030P090	0.35	2	6.7	3.0	45	44.6	0.4	45°	3	1
NEW 1.5	90°	●		DLE0150S030P090	0.55	3	7.3	4.5	45	44.4	0.6	45°	3	1
NEW 2.0	90°	●		DLE0200S030P090	0.8	4	7.9	6.1	45	44.1	0.9	45°	3	1
NEW 2.5	90°	●		DLE0250S030P090	1.0	5	7.9	7.1	45	43.9	1.1	45°	3	1
3.0	90°	●		DLE0300S030P090	1.2	9	—	—	45	43.7	1.3	45°	3	2
4.0	90°	●		DLE0400S040P090	1.6	12	—	—	50	48.3	1.7	45°	4	2
5.0	90°	●		DLE0500S050P090	2.0	14	—	—	60	57.9	2.1	45°	5	2
6.0	90°	●		DLE0600S060P090	2.4	15	—	—	66	63.4	2.6	45°	6	2
7.0	90°	●		DLE0700S070P090	2.8	18	—	—	74	71.0	3.0	45°	7	2
8.0	90°	●		DLE0800S080P090	3.2	20	—	—	74	70.6	3.4	45°	8	2
10.0	90°	●		DLE1000S100P090	4.1	24	—	—	84	79.7	4.3	45°	10	2
12.0	90°	●		DLE1200S120P090	4.9	28	—	—	95	89.9	5.1	45°	12	2
16.0	90°	●		DLE1600S160P090	6.6	35	—	—	113	106.2	6.8	45°	16	2

Uwaga 1) Podwójny kąt wierzchołkowy (średnica ok. DC/4) powoduje, że kąt środkowej części dna otworu różny od 60° i 90°. Tej części nie można użyć do fazowania krawędzi.

Uwaga 2) Średnica nakielka powinna być mniejsza od średnicy wiertła (średnicy skrawania) DC, długość użytkowa LU jest podana orientacyjnie.

● : Standard magazynowy. ★ : Na specjalne zamówienie z magazynu w Japonii.

DC (mm)	SIG	DP1020	DP102A	Numer zamówieniowy	Wymiary (mm)								Typ	
					LU	LCF	LH	S10	OAL	LF	PL	KAPR		DCON
NEW 3.0	120°	●		DLE0300S030P120	0.8	9	—	—	45	44.1	0.9	30°	3	2
NEW 4.0	120°	●		DLE0400S040P120	1.1	12	—	—	50	48.8	1.2	30°	4	2
NEW 5.0	120°	●		DLE0500S050P120	1.3	14	—	—	60	58.6	1.4	30°	5	2
NEW 6.0	120°	●		DLE0600S060P120	1.6	15	—	—	66	64.3	1.7	30°	6	2
NEW 7.0	120°	●		DLE0700S070P120	1.9	18	—	—	74	72.0	2.0	30°	7	2
NEW 8.0	120°	●		DLE0800S080P120	2.2	20	—	—	74	71.7	2.3	30°	8	2
NEW 10.0	120°	●		DLE1000S100P120	2.8	24	—	—	84	81.1	2.9	30°	10	2
NEW 12.0	120°	●		DLE1200S120P120	3.3	28	—	—	95	91.5	3.5	30°	12	2
NEW 3.0	145°	●		DLE0300S030P145	0.4	9	—	—	45	44.5	0.5	17.5°	3	2
NEW 4.0	145°	●		DLE0400S040P145	0.5	12	—	—	50	49.4	0.6	17.5°	4	2
NEW 5.0	145°	●		DLE0500S050P145	0.7	14	—	—	60	59.2	0.8	17.5°	5	2
NEW 6.0	145°	●		DLE0600S060P145	0.8	15	—	—	66	65.1	0.9	17.5°	6	2
NEW 7.0	145°	●		DLE0700S070P145	1.0	18	—	—	74	72.9	1.1	17.5°	7	2
NEW 8.0	145°	●		DLE0800S080P145	1.1	20	—	—	74	72.7	1.3	17.5°	8	2
NEW 10.0	145°	●		DLE1000S100P145	1.4	24	—	—	84	82.4	1.6	17.5°	10	2
NEW 12.0	145°	●		DLE1200S120P145	1.7	28	—	—	95	93.1	1.9	17.5°	12	2

Uwaga 1) Średnica nakielka powinna być mniejsza od średnicy wiertła (średnicy skrawania) DC, długość użytkowa LU jest podana orientacyjnie.

M

WIERCENIE

DOBÓR ŚREDNICY NAWIERTAKA

FAZOWANIE

Dla otworu o średnicy D , średnica nawiertaka (średnica skrawania) DC powinna mieścić się w zakresie $D < DC < 2D$.

M

WIERCENIE

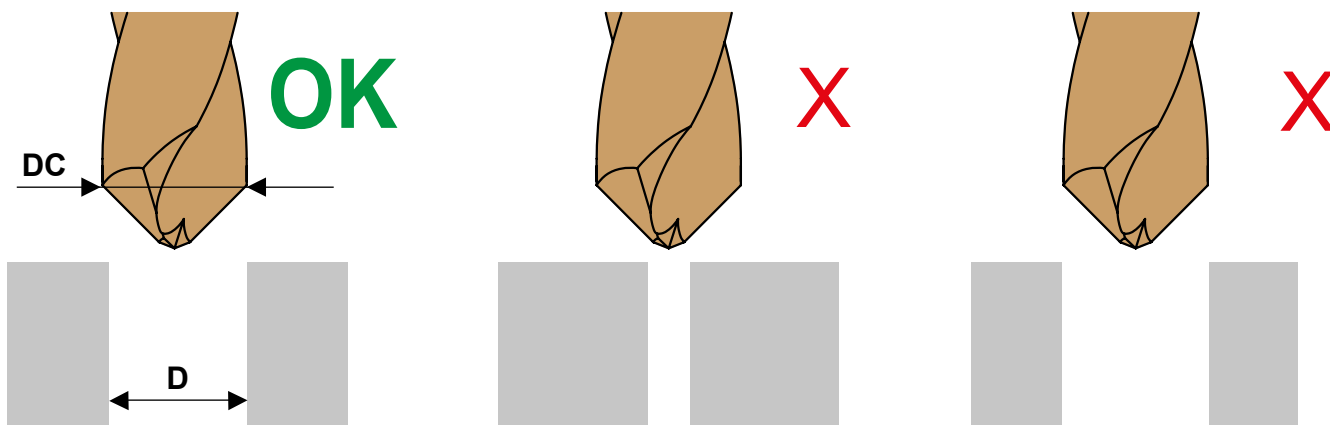

Przykład) średnica otworu D jest równa 5 mm: Średnica wiertła DC powinna być większa od 6 mm, ale mniejsza od 10 mm. Należy wybrać nawiertak o $DC = 6$ mm, 7 mm lub 8 mm.

Gdy DC jest równa lub większa od dwukrotnej średnicy otworu ($2D$):

Jeśli średnica nawiertaka DC jest za duża w porównaniu ze średnicą otworu D (większa lub równa $2D$), fazowania nie można wykonać.

Gdy średnica wiertła jest równa lub mniejsza niż D :

Fazowania nie można wykonać, gdy średnica nawiertaka DC jest równa średnicy otworu D .

NAWIERCANIE NAKIEŁKÓW

Średnica nakiełka powinna być mniejsza od średnicy wiertła (średnicy skrawania) DC , długość użytkowa LU podana orientacyjnie.

Kąt środkowej części dna otworu (ok. 25% średnicy zewn.) wykonywana końcówką wiertła o podwójnym kącie wierzchołkowym będzie różny od 60° i 90° . W części środkowej fazowania nie można wykonać.

Jeśli konieczny jest kontakt wiertła głównego ze środkiem otworu, należy użyć nawiertaka o większym kącie wierzchołkowym niż wiertła głównego.

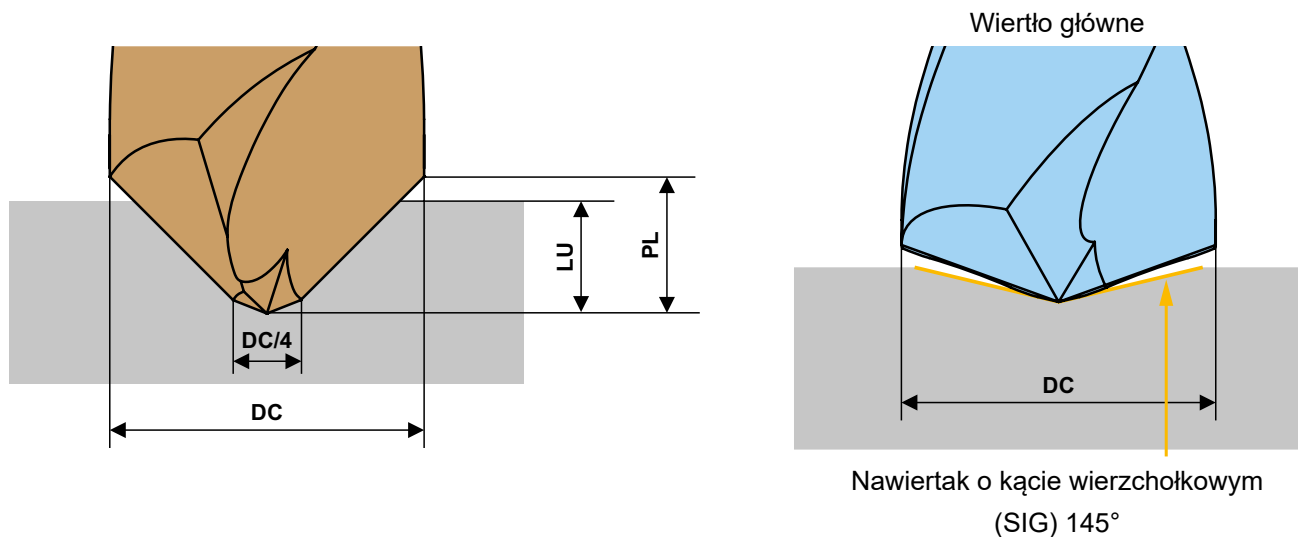

Głębokość wiercenia (L) w zależności od średnicy wiertła

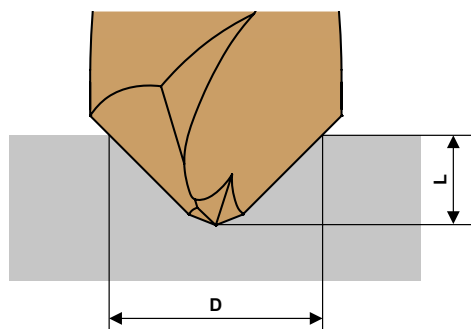

(mm)

DC	SIG 90°			
	Min.		Max.	
	D	L	D	L
1.0	0.5	0.18	0.8	0.33
1.5	0.8	0.29	1.3	0.54
2.0	1.0	0.35	1.9	0.8
2.5	1.3	0.47	2.4	1.0
3.0	1.5	0.5	2.8	1.2
4.0	2.0	0.7	3.8	1.6
5.0	2.5	0.9	4.7	2.0
6.0	3.0	1.1	5.7	2.4
7.0	3.5	1.2	6.6	2.8
8.0	4.0	1.4	7.6	3.2
10.0	5.0	1.8	9.7	4.1
12.0	6.0	2.1	11.6	4.9
16.0	8.0	2.8	15.5	6.6

M

WIERCENIE

(mm)

DC	SIG 60°				SIG 120°				SIG 145°			
	Min.		Max.		Min.		Max.		Min.		Max.	
	D	L	D	L	D	L	D	L	D	L	D	L
3.0	1.5	0.8	2.9	2.0	1.5	0.4	2.8	0.8	1.5	0.2	2.5	0.4
4.0	2.0	1.1	3.9	2.7	2.0	0.6	3.8	1.1	2.0	0.3	3.2	0.5
5.0	2.5	1.3	4.9	3.4	2.5	0.7	4.5	1.3	2.5	0.4	4.4	0.7
6.0	3.0	1.6	5.8	4.0	3.0	0.9	5.5	1.6	3.0	0.5	5.1	0.8
7.0	3.5	1.9	6.8	4.7	3.5	1.0	6.6	1.9	3.5	0.6	6.3	1.0
8.0	4.0	2.1	7.8	5.4	4.0	1.2	7.6	2.2	4.0	0.6	7.0	1.1
10.0	5.0	2.7	9.8	6.8	5.0	1.4	9.7	2.8	5.0	0.8	8.9	1.4
12.0	6.0	3.2	11.6	8.1	6.0	1.7	11.4	3.3	6.0	0.9	10.8	1.7

WIERCENIE (WIERTŁA PEŁNOWĘGLIKOWE)

DLE

Wiodąca seria nawiertaków

Kąt wierzchołkowy (SIG) 60°

ZALECANE PARAMETRY SKRAWANIA

Materiał przedmiotu obrabianego	P					
	Stal konstrukcyjna ($\leq 180\text{HB}$) DIN C10E itd.		Stal węglowa, Stal stopowa (180–280HB) DIN Ck45, 41CrMo4 itd.		Stal węglowa, Stal stopowa (280–350HB) DIN 40CrNiMoA itd.	
Średnica wiertła DC (mm)	Obroty (min^{-1})	Posuw (min.–maks.) (mm/obr.)	Obroty (min^{-1})	Posuw (min.–maks.) (mm/obr.)	Obroty (min^{-1})	Posuw (min.–maks.) (mm/obr.)
3.0	7900	0.05 (0.03–0.07)	6800	0.05 (0.03–0.07)	6300	0.04 (0.02–0.06)
4.0	5900	0.05 (0.03–0.07)	5100	0.05 (0.03–0.07)	4700	0.04 (0.02–0.06)
5.0	5000	0.06 (0.04–0.08)	4400	0.06 (0.04–0.08)	4100	0.05 (0.03–0.07)
6.0	4200	0.06 (0.04–0.08)	3700	0.06 (0.04–0.08)	3400	0.05 (0.03–0.07)
7.0	3600	0.07 (0.04–0.09)	3100	0.07 (0.04–0.09)	2900	0.05 (0.03–0.07)
8.0	3100	0.07 (0.04–0.09)	2700	0.07 (0.04–0.09)	2500	0.05 (0.03–0.07)
10.0	2700	0.08 (0.04–0.10)	2300	0.08 (0.04–0.10)	2200	0.06 (0.03–0.08)
12.0	2200	0.08 (0.04–0.10)	1900	0.08 (0.04–0.10)	1800	0.06 (0.03–0.08)

Materiał przedmiotu obrabianego	M		K			
	Austenityczna stal nierdzewna ($\leq 200\text{HB}$) DIN X5CrNi189, X5CrNiMo1810 itd.		Żeliwo szare ($\leq 350\text{MPa}$) DIN GG30 itd.		Żeliwo sferoidalne (GGG) ($\leq 450\text{MPa}$) DIN GGG40.3 itd.	
Średnica wiertła DC (mm)	Obroty (min^{-1})	Posuw (min.–maks.) (mm/obr.)	Obroty (min^{-1})	Posuw (min.–maks.) (mm/obr.)	Obroty (min^{-1})	Posuw (min.–maks.) (mm/obr.)
3.0	1500	0.03 (0.01–0.05)	7900	0.05 (0.03–0.07)	5800	0.05 (0.03–0.07)
4.0	1100	0.03 (0.01–0.05)	5900	0.05 (0.03–0.07)	4300	0.05 (0.03–0.07)
5.0	1200	0.04 (0.02–0.06)	5000	0.06 (0.04–0.08)	3800	0.06 (0.04–0.08)
6.0	1000	0.04 (0.02–0.06)	4200	0.06 (0.04–0.08)	3100	0.06 (0.04–0.08)
7.0	900	0.04 (0.02–0.06)	3600	0.07 (0.04–0.09)	2700	0.06 (0.04–0.08)
8.0	790	0.04 (0.02–0.06)	3100	0.07 (0.04–0.09)	2300	0.06 (0.04–0.08)
10.0	630	0.04 (0.02–0.06)	2700	0.08 (0.04–0.10)	1900	0.07 (0.04–0.09)
12.0	530	0.04 (0.02–0.06)	2200	0.08 (0.04–0.10)	1500	0.07 (0.04–0.09)

Uwaga 1) Podczas fazowania średnica narzędzia (DC) powinna wynosić $D < DC < 2DC$.

Uwaga 2) Podczas nawiercania krzywych lub nachylonych powierzchni należy zmniejszyć posuw.

Uwaga 3) Podczas obróbki rowków klinowych i fazowania należy zmniejszyć parametry skrawania.

Uwaga 4) W przypadku drgań narzędzia i nadmiernego hałasu, prosimy zatrzymać posuw lub zmniejszyć obroty.

Uwaga 5) Podczas nawiercania nie przekroczyć długości użytkowej narzędzia (LU).

WSKAZÓWKI EKSPLOATACYJNE

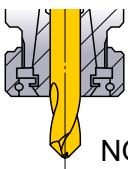
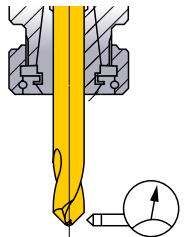
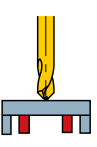
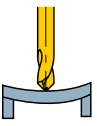
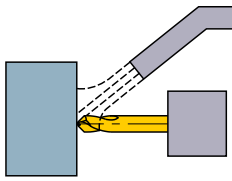
Zamocowanie wiertła	Długość wiertła	Tolerancja montażu	Cienkie przedmioty obrabiane	Metoda chłodzenia
 <p>Uchwyt z tuleją wciągana i łożyskiem oporowym silnie mocuje narzędzie.</p>	 <p>Nie mocować wiertła za rowek wiórowy.</p>	 <p>Bicie $\leq 0.03\text{mm}$</p>	 <p>OK Umieścić przedmiot obrabiany na podpórcie</p>  <p>X W razie wystąpienia zginania</p>	 <p>Dwie pozycje doprowadzenia chłodziwa, na końcu i w środku wiertła są najlepsze.</p>

Kąt wierzchołkowy (SIG) 90°, 120°, 145°

ZALECANE PARAMETRY SKRAWANIA

Materiał przedmiotu obrabianego	P					
	Stal konstrukcyjna ($\leq 180\text{HB}$) DIN C10E itd.		Stal węglowa, Stal stopowa (180–280HB) DIN Ck45, 41CrMo4 itd.		Stal węglowa, Stal stopowa (280–350HB) DIN 40CrNiMoA itd.	
Średnica wiertła DC (mm)	Obroty (min^{-1})	Posuw (min.–maks.) (mm/obr.)	Obroty (min^{-1})	Posuw (min.–maks.) (mm/obr.)	Obroty (min^{-1})	Posuw (min.–maks.) (mm/obr.)
1.0	9500	0.02 (0.01–0.03)	6300	0.02 (0.01–0.03)	4700	0.02 (0.01–0.03)
1.5	9500	0.02 (0.01–0.03)	7400	0.02 (0.01–0.03)	6300	0.02 (0.01–0.03)
2.0	9500	0.04 (0.03–0.05)	7900	0.04 (0.03–0.05)	7100	0.04 (0.03–0.05)
2.5	9500	0.04 (0.03–0.05)	8200	0.04 (0.03–0.05)	7600	0.04 (0.03–0.05)
3.0	7900	0.06 (0.04–0.08)	6800	0.06 (0.04–0.08)	6300	0.05 (0.03–0.07)
4.0	5900	0.06 (0.04–0.08)	5100	0.06 (0.04–0.08)	4700	0.05 (0.03–0.07)
5.0	5000	0.07 (0.05–0.09)	4400	0.07 (0.05–0.09)	4100	0.06 (0.04–0.08)
6.0	4200	0.07 (0.05–0.09)	3700	0.07 (0.05–0.09)	3400	0.06 (0.04–0.08)
7.0	3600	0.08 (0.05–0.10)	3100	0.08 (0.05–0.10)	2900	0.06 (0.04–0.08)
8.0	3100	0.08 (0.05–0.10)	2700	0.08 (0.05–0.10)	2500	0.06 (0.04–0.08)
10.0	2700	0.09 (0.05–0.11)	2300	0.09 (0.05–0.11)	2200	0.07 (0.04–0.09)
12.0	2200	0.09 (0.05–0.11)	1900	0.09 (0.05–0.11)	1800	0.07 (0.04–0.09)
16.0	1700	0.12 (0.10–0.14)	1500	0.12 (0.10–0.14)	1400	0.08 (0.06–0.10)

Materiał przedmiotu obrabianego	M		K			
	Austenityczna stal nierdzewna ($\leq 200\text{HB}$) DIN X5CrNi189, X5CrNiMo1810 itd.		Żeliwo szare ($\leq 350\text{MPa}$) DIN GG30 itd.		Żeliwo sferoidalne (GGG) ($\leq 450\text{MPa}$) DIN GGG40.3 itd.	
Średnica wiertła DC (mm)	Obroty (min^{-1})	Posuw (min.–maks.) (mm/obr.)	Obroty (min^{-1})	Posuw (min.–maks.) (mm/obr.)	Obroty (min^{-1})	Posuw (min.–maks.) (mm/obr.)
1.0	6300	0.01 (0.005–0.015)	9500	0.02 (0.01–0.03)	3100	0.02 (0.01–0.03)
1.5	4200	0.01 (0.005–0.015)	9500	0.02 (0.01–0.03)	5300	0.02 (0.01–0.03)
2.0	3100	0.04 (0.03–0.05)	9500	0.04 (0.03–0.05)	6300	0.04 (0.03–0.05)
2.5	2500	0.04 (0.03–0.05)	9500	0.04 (0.03–0.05)	7000	0.04 (0.03–0.05)
3.0	2100	0.04 (0.02–0.06)	7900	0.06 (0.04–0.08)	5800	0.06 (0.04–0.08)
4.0	1600	0.04 (0.02–0.06)	5900	0.06 (0.04–0.08)	4300	0.06 (0.04–0.08)
5.0	1200	0.06 (0.04–0.08)	5000	0.07 (0.05–0.09)	3800	0.07 (0.05–0.09)
6.0	1000	0.06 (0.04–0.08)	4200	0.07 (0.05–0.09)	3100	0.07 (0.05–0.09)
7.0	900	0.06 (0.04–0.08)	3600	0.08 (0.05–0.10)	2700	0.07 (0.05–0.09)
8.0	790	0.06 (0.04–0.08)	3100	0.08 (0.05–0.10)	2300	0.07 (0.05–0.09)
10.0	630	0.06 (0.04–0.08)	2700	0.09 (0.05–0.11)	1900	0.08 (0.05–0.10)
12.0	530	0.06 (0.04–0.08)	2200	0.09 (0.05–0.11)	1500	0.08 (0.05–0.10)
16.0	390	0.08 (0.06–0.10)	1700	0.12 (0.10–0.14)	1100	0.11 (0.09–0.13)

Uwaga 1) Podczas fazowania średnica narzędzia (DC) powinna wynosić $D < DC < 2DC$.

Uwaga 2) Podczas nawiercania krzywych lub nachylonych powierzchni należy zmniejszyć posuw.

Uwaga 3) Podczas obróbki rowków klinowych i fazowania należy zmniejszyć parametry skrawania.

Uwaga 4) W przypadku drgań narzędzia i nadmiernego hałasu, prosimy zatrzymać posuw lub zmniejszyć obroty.

Uwaga 5) Podczas nawiercania nie przekroczyć długości użytkowej narzędzia (LU).

WIERCENIE (WIERTŁA PEŁNOWĘGLIKOWE)

MINI-MFE

Do Małej Średnicy



WĘGLIKI
SPIEKANE

P

M

K

N

S

H

Chłodzenie zewnętrzne

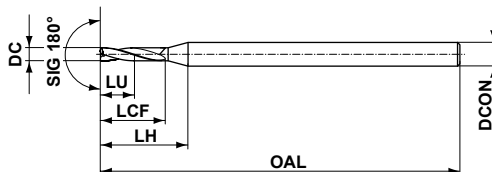

Typ 1

M

WIERCENIE

$0.75 \leq DC \leq 2.95$	
0 -0.014	
DCON=3	DCON=4
0 -0.006	0 -0.008

DC (mm)	Głębokość otworu (L/D)	DP102A	Numer zamówieniowy	Wymiary (mm)					Typ
				LU	LCF	LH	OAL	DCON	
0.75	2	★	MFE0075X02S030	1.5	3.0	7.7	45	3	1
0.80	2	★	MFE0080X02S030	1.6	3.2	7.8	45	3	1
0.85	2	★	MFE0085X02S030	1.7	3.4	7.9	45	3	1
0.90	2	★	MFE0090X02S030	1.8	3.6	8.0	45	3	1
0.95	2	★	MFE0095X02S030	1.9	3.8	8.1	45	3	1
1.00	2	★	MFE0100X02S030	2.0	4.0	8.2	45	3	1
1.05	2	★	MFE0105X02S030	2.1	4.2	8.3	45	3	1
1.10	2	★	MFE0110X02S030	2.2	4.4	8.4	45	3	1
1.15	2	★	MFE0115X02S030	2.3	4.6	8.6	45	3	1
1.20	2	★	MFE0120X02S030	2.4	4.8	8.7	45	3	1
1.25	2	★	MFE0125X02S030	2.5	5.0	8.8	45	3	1
1.30	2	★	MFE0130X02S030	2.6	5.2	8.9	45	3	1
1.35	2	★	MFE0135X02S030	2.7	5.4	9.0	45	3	1
1.40	2	★	MFE0140X02S030	2.8	5.6	9.1	45	3	1
1.45	2	★	MFE0145X02S030	2.9	5.8	9.2	45	3	1
1.50	2	★	MFE0150X02S030	3.0	6.0	9.3	45	3	1
1.55	2	★	MFE0155X02S030	3.1	6.2	9.4	45	3	1
1.60	2	★	MFE0160X02S030	3.2	6.4	9.5	45	3	1
1.65	2	★	MFE0165X02S030	3.3	6.6	9.6	45	3	1
1.70	2	★	MFE0170X02S030	3.4	6.8	9.7	45	3	1
1.75	2	★	MFE0175X02S030	3.5	7.0	9.8	45	3	1
1.80	2	★	MFE0180X02S030	3.6	7.2	9.9	45	3	1
1.85	2	★	MFE0185X02S030	3.7	7.4	10.0	45	3	1
1.90	2	★	MFE0190X02S030	3.8	7.6	10.2	45	3	1
1.95	2	★	MFE0195X02S030	3.9	7.8	10.3	45	3	1
2.00	2	★	MFE0200X02S040	4.0	8.0	12.2	50	4	1
2.05	2	★	MFE0205X02S040	4.1	8.2	12.3	50	4	1
2.10	2	★	MFE0210X02S040	4.2	8.4	12.4	50	4	1
2.15	2	★	MFE0215X02S040	4.3	8.6	12.6	50	4	1
2.20	2	★	MFE0220X02S040	4.4	8.8	12.7	50	4	1
2.25	2	★	MFE0225X02S040	4.5	9.0	12.8	50	4	1
2.30	2	★	MFE0230X02S040	4.6	9.2	12.9	50	4	1
2.35	2	★	MFE0235X02S040	4.7	9.4	13.0	50	4	1
2.40	2	★	MFE0240X02S040	4.8	9.6	13.1	50	4	1
2.45	2	★	MFE0245X02S040	4.9	9.8	13.2	50	4	1
2.50	2	★	MFE0250X02S040	5.0	10.0	13.3	50	4	1
2.55	2	★	MFE0255X02S040	5.1	10.2	13.4	50	4	1
2.60	2	★	MFE0260X02S040	5.2	10.4	13.5	50	4	1
2.65	2	★	MFE0265X02S040	5.3	10.6	13.6	50	4	1
2.70	2	★	MFE0270X02S040	5.4	10.8	13.7	50	4	1
2.75	2	★	MFE0275X02S040	5.5	11.0	13.8	50	4	1
2.80	2	★	MFE0280X02S040	5.6	11.2	13.9	50	4	1
2.85	2	★	MFE0285X02S040	5.7	11.4	14.0	50	4	1
2.90	2	★	MFE0290X02S040	5.8	11.6	14.2	50	4	1
2.95	2	★	MFE0295X02S040	5.9	11.8	14.3	50	4	1

★ : Na specjalne zamówienie z magazynu w Japonii.

ZALECANE PARAMETRY SKRAWANIA

Materiał przedmiotu obrabianego		P					
		Stal konstrukcyjna ($\leq 180\text{HB}$) C10E itd.		Stal węglowa, Stal stopowa (180–280HB) DIN Ck45, 41CrMo4 itd.		Stal węglowa, Stal stopowa (280–350HB) DIN 40CrNiMoA itd.	
Średnica wiertła DC (mm)	L/D	Obroty (min^{-1})	$\alpha=0^\circ$ Posuw (min.–maks.) (mm/obr.)	Obroty (min^{-1})	$\alpha=0^\circ$ Posuw (min.–maks.) (mm/obr.)	Obroty (min^{-1})	$\alpha=0^\circ$ Posuw (min.–maks.) (mm/obr.)
0.75	≤ 2	23300	0.030 (0.010–0.050)	19000	0.030 (0.010–0.050)	16900	0.030 (0.010–0.050)
1.0	≤ 2	17500	0.030 (0.010–0.050)	14300	0.030 (0.010–0.050)	12700	0.030 (0.010–0.050)
1.5	≤ 2	12200	0.035 (0.015–0.055)	10000	0.035 (0.015–0.055)	8400	0.035 (0.015–0.050)
2.0	≤ 2	9500	0.040 (0.020–0.060)	7900	0.040 (0.020–0.060)	6700	0.040 (0.020–0.060)
2.5	≤ 2	7900	0.050 (0.030–0.070)	6600	0.050 (0.030–0.070)	5700	0.050 (0.030–0.070)
2.95	≤ 2	7900	0.060 (0.040–0.080)	7900	0.060 (0.040–0.080)	6800	0.060 (0.040–0.080)

Materiał przedmiotu obrabianego		M		K			
		Austenityczna stal nierdzewna ($\leq 200\text{HB}$) DIN X5CrNi189, X5CrNiMo1810 itd.		Żeliwo szare ($\leq 350\text{MPa}$) DIN GG30 itd.		Żeliwo sferoidalne (GGG) ($\leq 450\text{MPa}$) DIN GGG40.3 itd.	
Średnica wiertła DC (mm)	L/D	Obroty (min^{-1})	$\alpha=0^\circ$ Posuw (min.–maks.) (mm/obr.)	Obroty (min^{-1})	$\alpha=0^\circ$ Posuw (min.–maks.) (mm/obr.)	Obroty (min^{-1})	$\alpha=0^\circ$ Posuw (min.–maks.) (mm/obr.)
0.75	≤ 2	10600	0.007 (0.003–0.011)	23300	0.030 (0.010–0.050)	16900	0.010 (0.005–0.015)
1.0	≤ 2	7900	0.007 (0.003–0.011)	17500	0.030 (0.010–0.050)	12700	0.010 (0.005–0.015)
1.5	≤ 2	5300	0.010 (0.005–0.015)	12200	0.035 (0.015–0.055)	10000	0.020 (0.010–0.030)
2.0	≤ 2	4700	0.015 (0.010–0.020)	9500	0.040 (0.020–0.060)	8700	0.030 (0.015–0.045)
2.5	≤ 2	3800	0.015 (0.010–0.020)	7900	0.050 (0.030–0.070)	7300	0.045 (0.025–0.065)
2.95	≤ 2	3100	0.020 (0.010–0.030)	7900	0.060 (0.040–0.080)	6800	0.050 (0.040–0.060)

Materiał przedmiotu obrabianego		N	
		Stopy aluminium ($\text{Si}<5\%$) JIS A6061, A7075 itd.	
Średnica wiertła DC (mm)	L/D	Obroty (min^{-1})	$\alpha=0^\circ$ Posuw (min.–maks.) (mm/obr.)
0.75	≤ 2	42400	0.020 (0.010–0.030)
1.0	≤ 2	31800	0.020 (0.010–0.030)
1.5	≤ 2	21200	0.020 (0.010–0.030)
2.0	≤ 2	17500	0.050 (0.030–0.070)
2.5	≤ 2	14000	0.060 (0.040–0.090)
2.95	≤ 2	11600	0.060 (0.040–0.090)

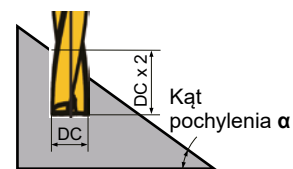

Uwaga 1) Zalecana głębokość otworu: $DC \times 2$. Głębokość otworu mierzona jest od najwyższego punktu otworu na powierzchniach ukośnych (Patrz rysunek)

Uwaga 2) Dane w tabeli powyżej dotyczą wiercenia w poziomej powierzchni.

Przy wierceniu otworów w powierzchniach nachylonych, należy dobrać posuw odpowiednio do kąta nachylenia.

Gdy kąt nachylenia α wynosi maks. 30° , należy ustawić posuw wynoszący maks. 70%.

Dla kąta nachylenia α powyżej 30° , należy ustawić posuw wynoszący 50% lub niższy.

Uwaga 3) Narzędzie służy wyłącznie do wiercenia otworów. Nie może być użyte do frezowania poprzecznego i do spiralnego.

WIERCENIE (WIERTŁA PEŁNOWĘGLIKOWE)

MINI-DWAE

NEW

Wiertła o małych średnicach



DC<2.0

P

M

K

N

S

H

Chłodzenie zewnętrzne



DC<2.0



DC≥2.0

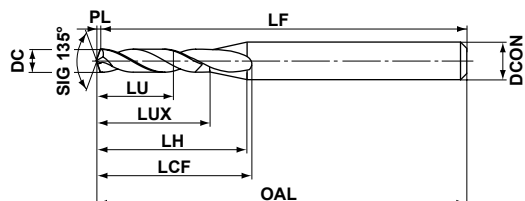

Typ 1

M

WIERCENIE



DC≤3	
0	
-0.014	



DCON=3	DCON=4
0	0
-0.006	-0.008

DC (mm)	Głębokość otworu (L/D)	DP102A	Numer zamówieniowy	Wymiary (mm)								Typ
				LU	LUX	LCF	LH	OAL	LF	PL	DCON	
1.0	2	●	DWAE0100X02S030	2.2	5.0	7.7	8.7	45.0	44.8	0.2	3	1
1.0	4	●	DWAE0100X04S030	4.2	7.0	9.9	10.7	45.0	44.8	0.2	3	1
1.1	2	★	DWAE0110X02S030	2.4	5.4	8.1	8.9	45.0	44.8	0.2	3	1
1.1	4	★	DWAE0110X04S030	4.6	7.6	10.5	11.1	45.0	44.8	0.2	3	1
1.2	2	★	DWAE0120X02S030	2.6	5.8	8.5	9.2	45.0	44.8	0.2	3	1
1.2	4	★	DWAE0120X04S030	5.0	8.2	11.1	11.6	45.0	44.8	0.2	3	1
1.3	2	★	DWAE0130X02S030	2.9	6.3	9.0	9.5	45.0	44.7	0.3	3	1
1.3	4	★	DWAE0130X04S030	5.5	8.9	11.9	12.1	45.0	44.7	0.3	3	1
1.4	2	★	DWAE0140X02S030	3.1	6.7	9.4	9.7	45.0	44.7	0.3	3	1
1.4	4	★	DWAE0140X04S030	5.9	9.5	12.5	12.5	45.0	44.7	0.3	3	1
1.5	2	●	DWAE0150X02S030	3.3	7.1	9.8	9.9	45.0	44.7	0.3	3	1
1.5	4	●	DWAE0150X04S030	6.3	10.1	13.1	12.9	45.0	44.7	0.3	3	1
1.6	2	★	DWAE0160X02S030	3.5	7.5	10.2	10.1	45.0	44.7	0.3	3	1
1.6	4	★	DWAE0160X04S030	6.7	10.7	13.7	13.3	45.0	44.7	0.3	3	1
1.7	2	★	DWAE0170X02S030	3.8	8.0	10.7	10.4	45.0	44.6	0.4	3	1
1.7	4	★	DWAE0170X04S030	7.2	11.4	14.4	13.8	45.0	44.6	0.4	3	1
1.8	2	★	DWAE0180X02S030	4.0	8.4	11.1	10.6	45.0	44.6	0.4	3	1
1.8	4	★	DWAE0180X04S030	7.6	12.0	15.1	14.2	45.0	44.6	0.4	3	1
1.9	2	★	DWAE0190X02S030	4.2	8.8	11.5	10.9	45.0	44.6	0.4	3	1
1.9	4	★	DWAE0190X04S030	8.0	12.6	15.7	14.7	45.0	44.6	0.4	3	1
2.0	2	●	DWAE0200X02S040	4.4	9.2	12.8	12.9	50.0	49.6	0.4	4	1
2.0	4	●	DWAE0200X04S040	8.4	13.2	17.2	16.9	50.0	49.6	0.4	4	1
2.1	2	★	DWAE0210X02S040	4.6	9.6	13.2	13.1	50.0	49.6	0.4	4	1
2.1	4	★	DWAE0210X04S040	8.8	13.8	17.8	17.3	50.0	49.6	0.4	4	1
2.2	2	★	DWAE0220X02S040	4.9	10.1	13.7	13.5	50.0	49.5	0.5	4	1
2.2	4	★	DWAE0220X04S040	9.3	14.5	18.5	17.9	50.0	49.5	0.5	4	1
2.3	2	★	DWAE0230X02S040	5.1	10.5	14.1	13.7	50.0	49.5	0.5	4	1
2.3	4	★	DWAE0230X04S040	9.7	15.1	19.2	18.3	50.0	49.5	0.5	4	1
2.4	2	★	DWAE0240X02S040	5.3	10.9	14.5	13.9	50.0	49.5	0.5	4	1
2.4	4	★	DWAE0240X04S040	10.1	15.7	19.8	18.7	50.0	49.5	0.5	4	1
2.5	2	●	DWAE0250X02S040	5.5	11.3	14.9	14.1	50.0	49.5	0.5	4	1
2.5	4	●	DWAE0250X04S040	10.5	16.3	20.4	19.1	50.0	49.5	0.5	4	1
2.6	2	★	DWAE0260X02S040	5.7	11.7	15.3	14.3	50.0	49.5	0.5	4	1
2.6	4	★	DWAE0260X04S040	10.9	16.9	21.0	19.5	50.0	49.5	0.5	4	1
2.7	2	★	DWAE0270X02S040	6.0	12.2	15.8	14.6	50.0	49.4	0.6	4	1
2.7	4	★	DWAE0270X04S040	11.4	17.6	21.7	20.0	50.0	49.4	0.6	4	1
2.8	2	★	DWAE0280X02S040	6.2	12.6	16.2	14.8	50.0	49.4	0.6	4	1
2.8	4	★	DWAE0280X04S040	11.8	18.2	22.4	20.4	50.0	49.4	0.6	4	1
2.9	2	★	DWAE0290X02S040	6.4	13.0	16.6	15.1	50.0	49.4	0.6	4	1
2.9	4	★	DWAE0290X04S040	12.2	18.8	23.0	20.9	50.0	49.4	0.6	4	1

● : Standard magazynowy. ★ : Na specjalne zamówienie z magazynu w Japonii.

P
M
K
N
S
H

Chłodzenie zewnętrzne

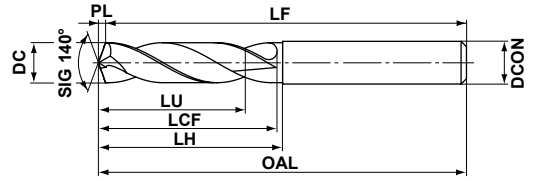

Typ 1



DC=3	3<DC≤6	6<DC≤10	10<DC≤14
$\begin{matrix} 0 \\ -0.014 \end{matrix}$	$\begin{matrix} 0 \\ -0.018 \end{matrix}$	$\begin{matrix} 0 \\ -0.022 \end{matrix}$	$\begin{matrix} 0 \\ -0.027 \end{matrix}$
DCON=3	3<DCON≤6	6<DCON≤10	10<DCON≤14
$\begin{matrix} 0 \\ -0.006 \end{matrix}$	$\begin{matrix} 0 \\ -0.008 \end{matrix}$	$\begin{matrix} 0 \\ -0.009 \end{matrix}$	$\begin{matrix} 0 \\ -0.011 \end{matrix}$



DC (mm)	Głębokość otworu (L/D)	DP102A	Numer zamówieniowy	Wymiary (mm)						Typ	
				LU	LCF	LH	OAL	LF	PL		DCON
3.0	2	●	DWAE0300X02S030	6.5	12.5	14.5	45.5	45	0.5	3	1
3.0	4	●	DWAE0300X04S030	12.5	21.5	23.5	55.5	55	0.5	3	1
3.1	2	●	DWAE0310X02S040	6.8	12.6	14.6	55.6	55	0.6	4	1
3.1	4	●	DWAE0310X04S040	13.0	21.6	23.6	60.6	60	0.6	4	1
3.2	2	●	DWAE0320X02S040	7.0	13.6	15.6	55.6	55	0.6	4	1
3.2	4	●	DWAE0320X04S040	13.4	22.6	24.6	60.6	60	0.6	4	1
3.3	2	●	DWAE0330X02S040	7.2	13.6	15.6	55.6	55	0.6	4	1
3.3	4	●	DWAE0330X04S040	13.8	23.6	25.6	60.6	60	0.6	4	1
3.4	2	●	DWAE0340X02S040	7.4	13.6	15.6	55.6	55	0.6	4	1
3.4	4	●	DWAE0340X04S040	14.2	23.6	25.6	60.6	60	0.6	4	1
3.5	2	●	DWAE0350X02S040	7.6	14.6	16.6	55.6	55	0.6	4	1
3.5	4	●	DWAE0350X04S040	14.6	24.6	26.6	60.6	60	0.6	4	1
3.6	2	●	DWAE0360X02S040	7.9	14.7	16.7	55.7	55	0.7	4	1
3.6	4	●	DWAE0360X04S040	15.1	25.7	27.7	60.7	60	0.7	4	1
3.7	2	●	DWAE0370X02S040	8.1	14.7	16.7	55.7	55	0.7	4	1
3.7	4	●	DWAE0370X04S040	15.5	25.7	27.7	60.7	60	0.7	4	1
3.8	2	●	DWAE0380X02S040	8.3	15.7	17.7	55.7	55	0.7	4	1
3.8	4	●	DWAE0380X04S040	15.9	26.7	28.7	60.7	60	0.7	4	1
3.9	2	●	DWAE0390X02S040	8.5	15.7	17.7	55.7	55	0.7	4	1
3.9	4	●	DWAE0390X04S040	16.3	27.7	29.7	60.7	60	0.7	4	1
4.0	2	●	DWAE0400X02S040	8.7	15.7	17.7	55.7	55	0.7	4	1
4.0	4	●	DWAE0400X04S040	16.7	27.7	29.7	60.7	60	0.7	4	1
4.1	2	●	DWAE0410X02S050	8.9	16.7	18.7	62.7	62	0.7	5	1
4.1	4	●	DWAE0410X04S050	17.1	28.7	30.7	80.7	80	0.7	5	1
4.2	2	●	DWAE0420X02S050	9.2	16.8	18.8	62.8	62	0.8	5	1
4.2	4	●	DWAE0420X04S050	17.6	29.8	31.8	80.8	80	0.8	5	1
4.3	2	●	DWAE0430X02S050	9.4	17.8	19.8	62.8	62	0.8	5	1
4.3	4	●	DWAE0430X04S050	18.0	30.8	32.8	80.8	80	0.8	5	1
4.4	2	●	DWAE0440X02S050	9.6	17.8	19.8	62.8	62	0.8	5	1
4.4	4	●	DWAE0440X04S050	18.4	30.8	32.8	80.8	80	0.8	5	1

WIERCENIE (WIERTŁA PEŁNOWĘGLIKOWE)

DWAE

NEW

 WĘGLIKI
SPIEKANE

M

WIERCENIE

DC (mm)	Głębokość otworu (L/D)	DP-102A	Numer zamówieniowy	Wymiary (mm)							Typ
				LU	LCF	LH	OAL	LF	PL	DCON	
4.5	2	●	DWAE0450X02S050	9.8	17.8	19.8	62.8	62	0.8	5	1
4.5	4	●	DWAE0450X04S050	18.8	31.8	33.8	80.8	80	0.8	5	1
4.6	2	●	DWAE0460X02S050	10.0	18.8	20.8	62.8	62	0.8	5	1
4.6	4	●	DWAE0460X04S050	19.2	32.8	34.8	80.8	80	0.8	5	1
4.7	2	●	DWAE0470X02S050	10.3	18.9	20.9	62.9	62	0.9	5	1
4.7	4	●	DWAE0470X04S050	19.7	32.9	34.9	80.9	80	0.9	5	1
4.8	2	●	DWAE0480X02S050	10.5	18.9	20.9	62.9	62	0.9	5	1
4.8	4	●	DWAE0480X04S050	20.1	33.9	35.9	80.9	80	0.9	5	1
4.9	2	●	DWAE0490X02S050	10.7	19.9	21.9	62.9	62	0.9	5	1
4.9	4	●	DWAE0490X04S050	20.5	34.9	36.9	80.9	80	0.9	5	1
5.0	2	●	DWAE0500X02S050	10.9	19.9	21.9	62.9	62	0.9	5	1
5.0	4	●	DWAE0500X04S050	20.9	34.9	36.9	80.9	80	0.9	5	1
5.1	2	★	DWAE0510X02S060	11.1	21.9	23.9	66.9	66	0.9	6	1
5.1	4	★	DWAE0510X04S060	21.3	35.9	37.9	80.9	80	0.9	6	1
5.2	2	●	DWAE0520X02S060	11.3	21.9	23.9	66.9	66	0.9	6	1
5.2	4	●	DWAE0520X04S060	21.7	36.9	38.9	80.9	80	0.9	6	1
5.3	2	★	DWAE0530X02S060	11.6	22.0	24.0	67.0	66	1.0	6	1
5.3	4	★	DWAE0530X04S060	22.2	37.0	39.0	81.0	80	1.0	6	1
5.4	2	●	DWAE0540X02S060	11.8	22.0	24.0	67.0	66	1.0	6	1
5.4	4	●	DWAE0540X04S060	22.6	38.0	40.0	81.0	80	1.0	6	1
5.5	2	★	DWAE0550X02S060	12.0	22.0	24.0	67.0	66	1.0	6	1
5.5	4	★	DWAE0550X04S060	23.0	39.0	41.0	81.0	80	1.0	6	1
5.6	2	●	DWAE0560X02S060	12.2	24.0	26.0	67.0	66	1.0	6	1
5.6	4	●	DWAE0560X04S060	23.4	39.0	41.0	81.0	80	1.0	6	1
5.7	2	★	DWAE0570X02S060	12.4	24.0	26.0	67.0	66	1.0	6	1
5.7	4	★	DWAE0570X04S060	23.8	39.0	41.0	81.0	80	1.0	6	1
5.8	2	●	DWAE0580X02S060	12.7	24.1	26.1	67.1	66	1.1	6	1
5.8	4	●	DWAE0580X04S060	24.3	41.1	43.1	81.1	80	1.1	6	1
5.9	2	★	DWAE0590X02S060	12.9	24.1	26.1	67.1	66	1.1	6	1
5.9	4	★	DWAE0590X04S060	24.7	41.1	43.1	81.1	80	1.1	6	1
6.0	2	●	DWAE0600X02S060	13.1	24.1	26.1	67.1	66	1.1	6	1
6.0	4	●	DWAE0600X04S060	25.1	42.1	44.1	81.1	80	1.1	6	1
6.1	2	★	DWAE0610X02S070	13.3	26.1	28.1	75.1	74	1.1	7	1
6.1	4	★	DWAE0610X04S070	25.5	44.1	46.1	84.1	83	1.1	7	1
6.2	2	●	DWAE0620X02S070	13.5	26.1	28.1	75.1	74	1.1	7	1
6.2	4	●	DWAE0620X04S070	25.9	44.1	46.1	84.1	83	1.1	7	1
6.3	2	★	DWAE0630X02S070	13.7	26.1	28.1	75.1	74	1.1	7	1
6.3	4	★	DWAE0630X04S070	26.3	44.1	46.1	84.1	83	1.1	7	1
6.4	2	●	DWAE0640X02S070	14.0	26.2	28.2	75.2	74	1.2	7	1
6.4	4	●	DWAE0640X04S070	26.8	44.2	46.2	84.2	83	1.2	7	1
6.5	2	★	DWAE0650X02S070	14.2	26.2	28.2	75.2	74	1.2	7	1
6.5	4	★	DWAE0650X04S070	27.2	44.2	46.2	84.2	83	1.2	7	1

● : Standard magazynowy. ★ : Na specjalne zamówienie z magazynu w Japonii.

DC (mm)	Głębokość otworu (L/D)	DP-102A	Numer zamówieniowy	Wymiary (mm)							Typ
				LU	LCF	LH	OAL	LF	PL	DCON	
6.6	2	●	DWAE0660X02S070	14.4	28.2	30.2	75.2	74	1.2	7	1
6.6	4	●	DWAE0660X04S070	27.6	46.2	48.2	84.2	83	1.2	7	1
6.7	2	★	DWAE0670X02S070	14.6	28.2	30.2	75.2	74	1.2	7	1
6.7	4	★	DWAE0670X04S070	28.0	46.2	48.2	84.2	83	1.2	7	1
6.8	2	●	DWAE0680X02S070	14.8	28.2	30.2	75.2	74	1.2	7	1
6.8	4	●	DWAE0680X04S070	28.4	46.2	48.2	84.2	83	1.2	7	1
6.9	2	★	DWAE0690X02S070	15.1	28.3	30.3	75.3	74	1.3	7	1
6.9	4	★	DWAE0690X04S070	28.9	46.3	48.3	84.3	83	1.3	7	1
7.0	2	●	DWAE0700X02S070	15.3	28.3	30.3	75.3	74	1.3	7	1
7.0	4	●	DWAE0700X04S070	29.3	46.3	48.3	84.3	83	1.3	7	1
7.1	2	★	DWAE0710X02S080	15.5	29.3	31.3	80.3	79	1.3	8	1
7.1	4	★	DWAE0710X04S080	29.7	51.3	53.3	91.3	90	1.3	8	1
7.2	2	●	DWAE0720X02S080	15.7	29.3	31.3	80.3	79	1.3	8	1
7.2	4	●	DWAE0720X04S080	30.1	51.3	53.3	91.3	90	1.3	8	1
7.3	2	★	DWAE0730X02S080	15.9	29.3	31.3	80.3	79	1.3	8	1
7.3	4	★	DWAE0730X04S080	30.5	51.3	53.3	91.3	90	1.3	8	1
7.4	2	●	DWAE0740X02S080	16.1	29.3	31.3	80.3	79	1.3	8	1
7.4	4	●	DWAE0740X04S080	30.9	51.3	53.3	91.3	90	1.3	8	1
7.5	2	★	DWAE0750X02S080	16.4	29.4	31.4	80.4	79	1.4	8	1
7.5	4	★	DWAE0750X04S080	31.4	51.4	53.4	91.4	90	1.4	8	1
7.6	2	●	DWAE0760X02S080	16.6	31.4	33.4	80.4	79	1.4	8	1
7.6	4	●	DWAE0760X04S080	31.8	53.4	55.4	91.4	90	1.4	8	1
7.7	2	★	DWAE0770X02S080	16.8	31.4	33.4	80.4	79	1.4	8	1
7.7	4	★	DWAE0770X04S080	32.2	53.4	55.4	91.4	90	1.4	8	1
7.8	2	●	DWAE0780X02S080	17.0	31.4	33.4	80.4	79	1.4	8	1
7.8	4	●	DWAE0780X04S080	32.6	53.4	55.4	91.4	90	1.4	8	1
7.9	2	★	DWAE0790X02S080	17.2	31.4	33.4	80.4	79	1.4	8	1
7.9	4	★	DWAE0790X04S080	33.0	53.4	55.4	91.4	90	1.4	8	1
8.0	2	●	DWAE0800X02S080	17.5	31.5	33.5	80.5	79	1.5	8	1
8.0	4	●	DWAE0800X04S080	33.5	53.5	55.5	91.5	90	1.5	8	1
8.1	2	★	DWAE0810X02S090	17.7	33.5	35.5	85.5	84	1.5	9	1
8.1	4	★	DWAE0810X04S090	33.9	57.5	59.5	99.5	98	1.5	9	1
8.2	2	●	DWAE0820X02S090	17.9	33.5	35.5	85.5	84	1.5	9	1
8.2	4	●	DWAE0820X04S090	34.3	57.5	59.5	99.5	98	1.5	9	1
8.3	2	★	DWAE0830X02S090	18.1	33.5	35.5	85.5	84	1.5	9	1
8.3	4	★	DWAE0830X04S090	34.7	57.5	59.5	99.5	98	1.5	9	1
8.4	2	●	DWAE0840X02S090	18.3	33.5	35.5	85.5	84	1.5	9	1
8.4	4	●	DWAE0840X04S090	35.1	57.5	59.5	99.5	98	1.5	9	1
8.5	2	★	DWAE0850X02S090	18.5	33.5	35.5	85.5	84	1.5	9	1
8.5	4	★	DWAE0850X04S090	35.5	57.5	59.5	99.5	98	1.5	9	1
8.6	2	●	DWAE0860X02S090	18.8	34.6	36.6	85.6	84	1.6	9	1
8.6	4	●	DWAE0860X04S090	36.0	61.6	63.6	99.6	98	1.6	9	1
8.7	2	★	DWAE0870X02S090	19.0	34.6	36.6	85.6	84	1.6	9	1
8.7	4	★	DWAE0870X04S090	36.4	61.6	63.6	99.6	98	1.6	9	1

WIERCENIE (WIERTŁA PEŁNOWĘGLIKOWE)

DWAE

NEW

 WĘGLIKI
SPIEKANE

M

WIERCENIE

DC (mm)	Głębokość otworu (L/D)	DP-102A	Numer zamówieniowy	Wymiary (mm)							Typ
				LU	LCF	LH	OAL	LF	PL	DCON	
8.8	2	●	DWAE0880X02S090	19.2	34.6	36.6	85.6	84	1.6	9	1
8.8	4	●	DWAE0880X04S090	36.8	61.6	63.6	99.6	98	1.6	9	1
8.9	2	★	DWAE0890X02S090	19.4	34.6	36.6	85.6	84	1.6	9	1
8.9	4	★	DWAE0890X04S090	37.2	61.6	63.6	99.6	98	1.6	9	1
9.0	2	●	DWAE0900X02S090	19.6	34.6	36.6	85.6	84	1.6	9	1
9.0	4	●	DWAE0900X04S090	37.6	61.6	63.6	99.6	98	1.6	9	1
9.1	2	★	DWAE0910X02S100	19.9	36.7	38.7	90.7	89	1.7	10	1
9.1	4	★	DWAE0910X04S100	38.1	63.7	65.7	106.7	105	1.7	10	1
9.2	2	●	DWAE0920X02S100	20.1	36.7	38.7	90.7	89	1.7	10	1
9.2	4	●	DWAE0920X04S100	38.5	63.7	65.7	106.7	105	1.7	10	1
9.3	2	★	DWAE0930X02S100	20.3	36.7	38.7	90.7	89	1.7	10	1
9.3	4	★	DWAE0930X04S100	38.9	63.7	65.7	106.7	105	1.7	10	1
9.4	2	●	DWAE0940X02S100	20.5	36.7	38.7	90.7	89	1.7	10	1
9.4	4	●	DWAE0940X04S100	39.3	63.7	65.7	106.7	105	1.7	10	1
9.5	2	★	DWAE0950X02S100	20.7	36.7	38.7	90.7	89	1.7	10	1
9.5	4	★	DWAE0950X04S100	39.7	63.7	65.7	106.7	105	1.7	10	1
9.6	2	●	DWAE0960X02S100	20.9	37.7	39.7	90.7	89	1.7	10	1
9.6	4	●	DWAE0960X04S100	40.1	66.7	68.7	106.7	105	1.7	10	1
9.7	2	★	DWAE0970X02S100	21.2	37.8	39.8	90.8	89	1.8	10	1
9.7	4	★	DWAE0970X04S100	40.6	66.8	68.8	106.8	105	1.8	10	1
9.8	2	●	DWAE0980X02S100	21.4	37.8	39.8	90.8	89	1.8	10	1
9.8	4	●	DWAE0980X04S100	41.0	66.8	68.8	106.8	105	1.8	10	1
9.9	2	★	DWAE0990X02S100	21.6	37.8	39.8	90.8	89	1.8	10	1
9.9	4	★	DWAE0990X04S100	41.4	66.8	68.8	106.8	105	1.8	10	1
10.0	2	●	DWAE1000X02S100	21.8	37.8	39.8	90.8	89	1.8	10	1
10.0	4	●	DWAE1000X04S100	41.8	66.8	68.8	106.8	105	1.8	10	1
10.1	2	●	DWAE1010X02S110	22.0	40.8	42.8	101.8	100	1.8	11	1
10.1	4	●	DWAE1010X04S110	42.2	71.8	73.8	115.8	114	1.8	11	1
10.2	2	●	DWAE1020X02S110	22.3	40.9	42.9	101.9	100	1.9	11	1
10.2	4	●	DWAE1020X04S110	42.7	71.9	73.9	115.9	114	1.9	11	1
10.3	2	●	DWAE1030X02S110	22.5	40.9	42.9	101.9	100	1.9	11	1
10.3	4	●	DWAE1030X04S110	43.1	71.9	73.9	115.9	114	1.9	11	1
10.4	2	●	DWAE1040X02S110	22.7	40.9	42.9	101.9	100	1.9	11	1
10.4	4	●	DWAE1040X04S110	43.5	71.9	73.9	115.9	114	1.9	11	1
10.5	2	●	DWAE1050X02S110	22.9	40.9	42.9	101.9	100	1.9	11	1
10.5	4	●	DWAE1050X04S110	43.9	71.9	73.9	115.9	114	1.9	11	1
10.6	2	●	DWAE1060X02S110	23.1	41.9	43.9	101.9	100	1.9	11	1
10.6	4	●	DWAE1060X04S110	44.3	72.9	74.9	115.9	114	1.9	11	1
10.7	2	●	DWAE1070X02S110	23.3	41.9	43.9	101.9	100	1.9	11	1
10.7	4	●	DWAE1070X04S110	44.7	72.9	74.9	115.9	114	1.9	11	1
10.8	2	●	DWAE1080X02S110	23.6	42.0	44.0	102.0	100	2.0	11	1
10.8	4	●	DWAE1080X04S110	45.2	73.0	75.0	116.0	114	2.0	11	1

● : Standard magazynowy. ★ : Na specjalne zamówienie z magazynu w Japonii.

DC (mm)	Głębokość otworu (L/D)	DP-102A	Numer zamówieniowy	Wymiary (mm)							Typ
				LU	LCF	LH	OAL	LF	PL	DCON	
10.9	2	●	DWAE1090X02S110	23.8	42.0	44.0	102.0	100	2.0	11	1
10.9	4	●	DWAE1090X04S110	45.6	73.0	75.0	116.0	114	2.0	11	1
11.0	2	●	DWAE1100X02S110	24.0	42.0	44.0	102.0	100	2.0	11	1
11.0	4	●	DWAE1100X04S110	46.0	73.0	75.0	116.0	114	2.0	11	1
11.1	2	●	DWAE1110X02S120	24.2	45.0	47.0	102.0	100	2.0	12	1
11.1	4	●	DWAE1110X04S120	46.4	77.0	79.0	123.0	121	2.0	12	1
11.2	2	●	DWAE1120X02S120	24.4	45.0	47.0	102.0	100	2.0	12	1
11.2	4	●	DWAE1120X04S120	46.8	77.0	79.0	123.0	121	2.0	12	1
11.3	2	●	DWAE1130X02S120	24.7	45.1	47.1	102.1	100	2.1	12	1
11.3	4	●	DWAE1130X04S120	47.3	77.1	79.1	123.1	121	2.1	12	1
11.4	2	●	DWAE1140X02S120	24.9	45.1	47.1	102.1	100	2.1	12	1
11.4	4	●	DWAE1140X04S120	47.7	77.1	79.1	123.1	121	2.1	12	1
11.5	2	●	DWAE1150X02S120	25.1	45.1	47.1	102.1	100	2.1	12	1
11.5	4	●	DWAE1150X04S120	48.1	77.1	79.1	123.1	121	2.1	12	1
11.6	2	●	DWAE1160X02S120	25.3	47.1	49.1	102.1	100	2.1	12	1
11.6	4	●	DWAE1160X04S120	48.5	79.1	81.1	123.1	121	2.1	12	1
11.7	2	●	DWAE1170X02S120	25.5	47.1	49.1	102.1	100	2.1	12	1
11.7	4	●	DWAE1170X04S120	48.9	79.1	81.1	123.1	121	2.1	12	1
11.8	2	●	DWAE1180X02S120	25.7	47.1	49.1	102.1	100	2.1	12	1
11.8	4	●	DWAE1180X04S120	49.3	79.1	81.1	123.1	121	2.1	12	1
11.9	2	●	DWAE1190X02S120	26.0	47.2	49.2	102.2	100	2.2	12	1
11.9	4	●	DWAE1190X04S120	49.8	79.2	81.2	123.2	121	2.2	12	1
12.0	2	●	DWAE1200X02S120	26.2	47.2	49.2	102.2	100	2.2	12	1
12.0	4	●	DWAE1200X04S120	50.2	79.2	81.2	123.2	121	2.2	12	1
12.1	2	●	DWAE1210X02S130	26.4	49.2	51.2	102.2	100	2.2	13	1
12.1	4	●	DWAE1210X04S130	50.6	82.2	84.2	139.2	137	2.2	13	1
12.2	2	●	DWAE1220X02S130	26.6	49.2	51.2	102.2	100	2.2	13	1
12.2	4	●	DWAE1220X04S130	51.0	82.2	84.2	139.2	137	2.2	13	1
12.3	2	●	DWAE1230X02S130	26.8	49.2	51.2	102.2	100	2.2	13	1
12.3	4	●	DWAE1230X04S130	51.4	82.2	84.2	139.2	137	2.2	13	1
12.4	2	●	DWAE1240X02S130	27.1	49.3	51.3	102.3	100	2.3	13	1
12.4	4	●	DWAE1240X04S130	51.9	82.3	84.3	139.3	137	2.3	13	1
12.5	2	●	DWAE1250X02S130	27.3	49.3	51.3	102.3	100	2.3	13	1
12.5	4	●	DWAE1250X04S130	52.3	82.3	84.3	139.3	137	2.3	13	1
12.6	2	●	DWAE1260X02S130	27.5	52.3	54.3	102.3	100	2.3	13	1
12.6	4	●	DWAE1260X04S130	52.7	84.3	86.3	139.3	137	2.3	13	1
12.7	2	●	DWAE1270X02S130	27.7	52.3	54.3	102.3	100	2.3	13	1
12.7	4	●	DWAE1270X04S130	53.1	84.3	86.3	139.3	137	2.3	13	1
12.8	2	●	DWAE1280X02S130	27.9	52.3	54.3	102.3	100	2.3	13	1
12.8	4	●	DWAE1280X04S130	53.5	84.3	86.3	139.3	137	2.3	13	1
12.9	2	●	DWAE1290X02S130	28.1	52.3	54.3	102.3	100	2.3	13	1
12.9	4	●	DWAE1290X04S130	53.9	84.3	86.3	139.3	137	2.3	13	1

WIERCENIE (WIERTŁA PEŁNOWĘGLIKOWE)

DWAE

NEW

 WĘGLIKI
SPIEKANE

WIERCENIE

M

DC (mm)	Głębokość otworu (L/D)	DP102A	Numer zamówieniowy	Wymiary (mm)							Typ
				LU	LCF	LH	OAL	LF	PL	DCON	
13.0	2	●	DWAE1300X02S130	28.4	52.4	54.4	102.4	100	2.4	13	1
13.0	4	●	DWAE1300X04S130	54.4	84.4	86.4	139.4	137	2.4	13	1
13.1	2	●	DWAE1310X02S140	28.6	55.4	57.4	102.4	100	2.4	14	1
13.1	4	●	DWAE1310X04S140	54.8	92.4	94.4	149.4	147	2.4	14	1
13.2	2	●	DWAE1320X02S140	28.8	55.4	57.4	102.4	100	2.4	14	1
13.2	4	●	DWAE1320X04S140	55.2	92.4	94.4	149.4	147	2.4	14	1
13.3	2	●	DWAE1330X02S140	29.0	55.4	57.4	102.4	100	2.4	14	1
13.3	4	●	DWAE1330X04S140	55.6	92.4	94.4	149.4	147	2.4	14	1
13.4	2	●	DWAE1340X02S140	29.2	55.4	57.4	102.4	100	2.4	14	1
13.4	4	●	DWAE1340X04S140	56.0	92.4	94.4	149.4	147	2.4	14	1
13.5	2	●	DWAE1350X02S140	29.5	55.5	57.5	102.5	100	2.5	14	1
13.5	4	●	DWAE1350X04S140	56.5	92.5	94.5	149.5	147	2.5	14	1
13.6	2	●	DWAE1360X02S140	29.7	57.5	59.5	102.5	100	2.5	14	1
13.6	4	●	DWAE1360X04S140	56.9	97.5	99.5	149.5	147	2.5	14	1
13.7	2	●	DWAE1370X02S140	29.9	57.5	59.5	102.5	100	2.5	14	1
13.7	4	●	DWAE1370X04S140	57.3	97.5	99.5	149.5	147	2.5	14	1
13.8	2	●	DWAE1380X02S140	30.1	57.5	59.5	102.5	100	2.5	14	1
13.8	4	●	DWAE1380X04S140	57.7	97.5	99.5	149.5	147	2.5	14	1
13.9	2	●	DWAE1390X02S140	30.3	57.5	59.5	102.5	100	2.5	14	1
13.9	4	●	DWAE1390X04S140	58.1	97.5	99.5	149.5	147	2.5	14	1
14.0	2	●	DWAE1400X02S140	30.5	57.5	59.5	102.5	100	2.5	14	1
14.0	4	●	DWAE1400X04S140	58.5	97.5	99.5	149.5	147	2.5	14	1

● : Standard magazynowy.

ZALECANE PARAMETRY SKRAWANIA

Materiał przedmiotu obrabianego	P							
	Stale konstrukcyjne ($\leq 180\text{HB}$)				Stale węglowe, stopowe ($180-250\text{HB}$)			
	EU S275JR, Ck10, itd.				C45, 42CrMo4 itd.			
Średnica wiertła DC (mm)	Prędkość skrawania (m/min)	Obroty (min^{-1})	Posuw (min. – maks.) (mm/obr.)	Posuw stołu (mm/min)	Prędkość skrawania (m/min)	Obroty (min^{-1})	Posuw (min. – maks.) (mm/obr.)	Posuw stołu (mm/min)
1.0	30	9500	0.03 (0.02–0.04)	285	30	9500	0.03 (0.02–0.04)	285
1.5	30	6300	0.05 (0.03–0.06)	315	30	6300	0.05 (0.03–0.06)	315
2.0	55	8700	0.06 (0.04–0.08)	520	55	8700	0.06 (0.04–0.08)	520
2.5	55	7000	0.08 (0.05–0.10)	560	55	7000	0.08 (0.05–0.10)	560
3.0	65	6800	0.09 (0.07–0.11)	610	60	6300	0.09 (0.07–0.11)	565
4.0	70	5500	0.12 (0.09–0.14)	660	65	5100	0.12 (0.09–0.14)	610
5.0	70	4400	0.15 (0.11–0.18)	660	65	4100	0.15 (0.11–0.18)	615
6.0	80	4200	0.18 (0.14–0.21)	755	75	3900	0.18 (0.14–0.21)	700
7.0	80	3600	0.21 (0.16–0.25)	755	75	3400	0.21 (0.16–0.25)	715
8.0	85	3300	0.23 (0.18–0.28)	760	80	3100	0.23 (0.18–0.28)	715
10.0	90	2800	0.27 (0.21–0.32)	755	85	2700	0.27 (0.21–0.32)	730
12.0	95	2500	0.28 (0.22–0.34)	700	90	2300	0.28 (0.22–0.34)	645
14.0	95	2100	0.29 (0.23–0.35)	610	90	2000	0.29 (0.23–0.35)	580

Materiał przedmiotu obrabianego	P				M			
	Stale węglowe, stopowe ($280-350\text{HB}$)				Austeniczne stale nierdzewne ($\leq 200\text{HB}$) Stale nierdzewne ferrytyczne i martenzytyczne ($> 200\text{HB}$)			
	40CrNiMo itd.				X12CrS13, X30Cr13 itd.			
Średnica wiertła DC (mm)	Prędkość skrawania (m/min)	Obroty (min^{-1})	Posuw (min. – maks.) (mm/obr.)	Posuw stołu (mm/min)	Prędkość skrawania (m/min)	Obroty (min^{-1})	Posuw (min. – maks.) (mm/obr.)	Posuw stołu (mm/min)
1.0	25	7900	0.02 (0.01–0.03)	160	30	9500	0.02 (0.01–0.03)	190
1.5	25	5300	0.04 (0.02–0.05)	210	30	6300	0.04 (0.02–0.05)	250
2.0	50	7900	0.05 (0.03–0.07)	395	35	5500	0.04 (0.02–0.06)	220
2.5	50	6300	0.07 (0.04–0.09)	440	35	4400	0.06 (0.03–0.08)	265
3.0	55	5800	0.08 (0.06–0.09)	465	40	4200	0.07 (0.04–0.10)	295
4.0	60	4700	0.11 (0.08–0.13)	515	40	3100	0.08 (0.05–0.10)	250
5.0	60	3800	0.13 (0.10–0.16)	495	40	2500	0.10 (0.05–0.15)	250
6.0	70	3700	0.16 (0.12–0.19)	590	40	2100	0.11 (0.06–0.15)	230
7.0	70	3100	0.18 (0.14–0.22)	560	40	1800	0.12 (0.06–0.18)	215
8.0	75	2900	0.21 (0.16–0.25)	610	40	1500	0.13 (0.06–0.20)	195
10.0	80	2500	0.24 (0.20–0.28)	600	40	1200	0.14 (0.08–0.20)	170
12.0	85	2200	0.25 (0.20–0.30)	550	40	1000	0.18 (0.10–0.25)	180
14.0	85	1900	0.25 (0.20–0.30)	475	40	900	0.18 (0.10–0.25)	160

Uwaga 1) Podane wyżej parametry skrawania dotyczą użycia chłodziwa wodorocieńczalnego. Do wiercenia w stalach nierdzewnych zalecane jest chłodziwo nierozcieńczalne w wodzie.

Uwaga 2) W przypadku użycia chłodziwa nierozcieńczalnego w wodzie, aby zapewnić odpowiednie smarowanie, należy zmniejszyć prędkość skrawania o 20%.

Uwaga 3) Sprawdzić stan wiórów i w razie potrzeby wykonać wiercenie stopniowe (z wycofaniem wiertła). * Orientacyjna długość wycofania: od 0.2 do 1.0 DC

Uwaga 4) Dostosować parametry skrawania do sztywności obrabiarki, zamocowania przedmiotu obrabianego, geometrii skrawania itd.

Uwaga 5) Niezalecane są głębokości skrawania większe od długości użytkowej (LU).

Uwaga 6) Zamocować wiertło tak, aby bicie nie przekroczyło 0.03 mm.

Uwaga 7) Nie mocować wiertła za rowek wiórowy.

M

WIERCENIE

WIERCENIE (WIERTŁA PEŁNOWĘGLIKOWE)

WĘGLIKI
SPIEKANE

ZALECANE PARAMETRY SKRAWANIA

Materiał przedmiotu obrabianego	K							
	Żeliwa szare ($\leq 350\text{MPa}$)				Żeliwa sferoidalne ($\leq 450\text{MPa}$)			
	GG30 itp.				EN-GJS-450-10 itd.			
Średnica wiertła DC (mm)	Prędkość skrawania (m/min)	Obroty (min^{-1})	Posuw (min. – maks.) (mm/obr.)	Posuw stołu (mm/min)	Prędkość skrawania (m/min)	Obroty (min^{-1})	Posuw (min. – maks.) (mm/obr.)	Posuw stołu (mm/min)
1.0	30	9500	0.03 (0.02–0.04)	285	25	7900	0.02 (0.01–0.03)	160
1.5	30	6300	0.05 (0.03–0.06)	315	25	5300	0.04 (0.02–0.05)	210
2.0	55	8700	0.06 (0.04–0.08)	520	50	7900	0.05 (0.03–0.07)	395
2.5	55	7000	0.08 (0.05–0.10)	560	50	6300	0.07 (0.04–0.09)	440
3.0	65	6800	0.09 (0.07–0.11)	610	55	5800	0.09 (0.05–0.12)	520
4.0	70	5500	0.12 (0.09–0.14)	660	60	4700	0.12 (0.07–0.17)	565
5.0	70	4400	0.15 (0.11–0.18)	660	60	3800	0.14 (0.08–0.20)	530
6.0	80	4200	0.18 (0.14–0.21)	755	70	3700	0.15 (0.10–0.20)	555
7.0	80	3600	0.21 (0.16–0.25)	755	70	3100	0.18 (0.12–0.23)	560
8.0	85	3300	0.23 (0.18–0.28)	760	75	2900	0.20 (0.15–0.25)	580
10.0	90	2800	0.27 (0.21–0.32)	755	80	2500	0.23 (0.18–0.28)	575
12.0	95	2500	0.28 (0.22–0.34)	700	85	2200	0.25 (0.20–0.30)	550
14.0	95	2100	0.29 (0.23–0.35)	610	85	1900	0.25 (0.20–0.30)	475

Uwaga 1) Podane wyżej parametry skrawania dotyczą użycia chłodziwa wodorociekłego. Do wiercenia w stalach nierdzewnych zalecane jest chłodziwo nierozcieńczalne w wodzie.

Uwaga 2) W przypadku użycia chłodziwa nierozcieńczalnego w wodzie, aby zapewnić odpowiednie smarowanie, należy zmniejszyć prędkość skrawania o 20%.

Uwaga 3) Sprawdzić stan wiórów i w razie potrzeby wykonać wiercenie stopniowe (z wycofaniem wiertła). * Orientacyjna długość wycofania: od 0.2 do 1.0 DC

Uwaga 4) Dostosować parametry skrawania do sztywności obrabiarki, zamocowania przedmiotu obrabianego, geometrii skrawania itd.

Uwaga 5) Niezalecane są głębokości skrawania większe od długości użytkowej (LU).

Uwaga 6) Zamocować wiertło tak, aby bicie nie przekroczyło 0.03 mm.

Uwaga 7) Nie mocować wiertła za rowek wiórowy.

M

WIERCENIE

TYPOSZEREGI WIERTEŁ

M

WIERCENIE



Notatki

A series of horizontal dashed lines for writing notes, spanning the width of the page.

DIA EDGE

TWORZYĆ LĘPSZĄ, PRZYSZŁOŚĆ WSPÓLNIE Z NASZYM KLIENTAMI

Prezentujemy DIAEDGE, nową markę naszych narzędzi, która łączy najnowsze technologie, ekscytując wszystkich, którzy z nich korzystają.

Naszym celem jest nie tylko uzyskanie przez klientów wartości dodanej dzięki naszym narzędziom, ale także bliska współpraca z nimi, dzielenie się inspiracjami i podejmowanie wciąż nowych wyzwań.



MITSUBISHI MATERIALS

DIA EDGE



 MITSUBISHI MATERIALS

WIERTŁA

M

WIERCENIE



WIERCENIE (WIERTŁA PEŁNOWĘGLIKOWE)

MINI-MVS

- Prosta krawędź skrawająca zapewnia lepsze odprowadzanie wióra i wyższą wytrzymałość krawędzi skrawającej.
- Podwójna tyśinka zapewnia optymalną jakość i dokładność otworów o małej średnicy.



WĘGLIKI
SPIEKANE



Chłodzenie wewnętrzne

M

WIERCENIE

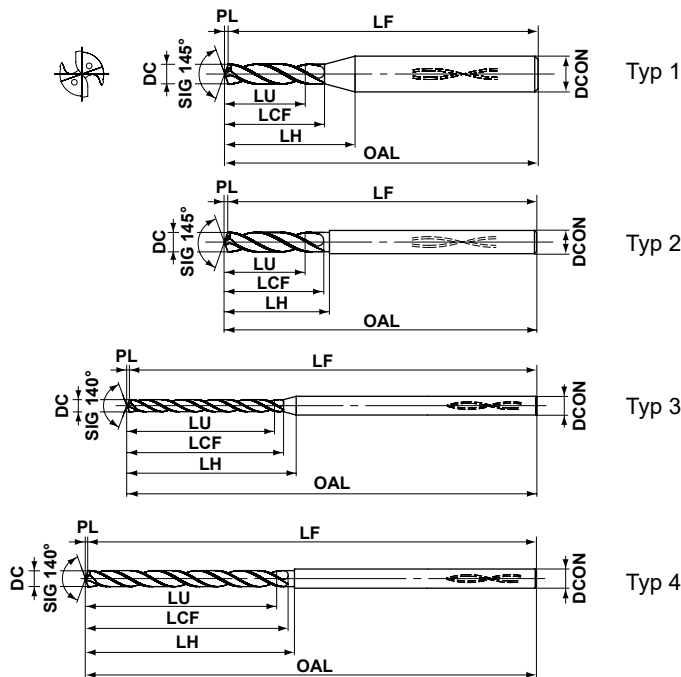

Numer zamówieniowy	1 ≤ DC ≤ 2.9
MVS-X02- (wierło pilotowe)	+0.014 0
Inne	0 -0.014
Numer zamówieniowy	DCON
MVS	0 -0.006



DC (mm)	Głębokość otworu (L/D)	DP1020	Numer zamówieniowy	Wymiary (mm)							Typ
				LU	LCF	LH	OAL	LF	PL	DCON	
1.0	*2	●	MVS0100X02S030	2.2	5.2	8.9	55.2	55	0.2	3	1
	7	●	MVS0100X07S030	7.2	10.2	14.2	55.2	55	0.2	3	3
	12	●	MVS0100X12S030	12.2	15.2	19.2	55.2	55	0.2	3	3
	20	●	MVS0100X20S030	20.2	24.2	28.2	60.2	60	0.2	3	3
	25	●	MVS0100X25S030	25.2	28.2	32.2	66.2	66	0.2	3	3
	30	●	MVS0100X30S030	30.2	33.2	37.2	72.2	72	0.2	3	3
1.1	*2	●	MVS0110X02S030	2.4	5.6	9.1	55.2	55	0.2	3	1
	7	●	MVS0110X07S030	7.9	11.2	15.2	55.2	55	0.2	3	3
	12	●	MVS0110X12S030	13.4	17.2	21.2	55.2	55	0.2	3	3
	20	●	MVS0110X20S030	22.2	25.2	29.2	60.2	60	0.2	3	3
	25	●	MVS0110X25S030	27.7	31.2	34.2	66.2	66	0.2	3	3
	30	●	MVS0110X30S030	33.2	36.2	40.2	72.2	72	0.2	3	3
1.2	*2	●	MVS0120X02S030	2.6	6.2	9.6	55.2	55	0.2	3	1
	7	●	MVS0120X07S030	8.6	12.2	15.2	55.2	55	0.2	3	3
	12	●	MVS0120X12S030	14.6	18.2	21.2	55.2	55	0.2	3	3
	20	●	MVS0120X20S030	24.2	28.2	31.2	60.2	60	0.2	3	3
	25	●	MVS0120X25S030	30.2	34.2	37.2	66.2	66	0.2	3	3
	30	●	MVS0120X30S030	36.2	40.2	43.2	72.2	72	0.2	3	3
1.3	*2	●	MVS0130X02S030	2.8	6.6	9.8	55.2	55	0.2	3	1
	7	●	MVS0130X07S030	9.3	13.2	16.2	55.2	55	0.2	3	3
	12	●	MVS0130X12S030	15.8	20.2	23.2	55.2	55	0.2	3	3
	20	●	MVS0130X20S030	26.2	30.2	33.2	68.2	68	0.2	3	3
	25	●	MVS0130X25S030	32.7	36.2	40.2	74.2	74	0.2	3	3
	30	●	MVS0130X30S030	39.2	43.2	46.2	82.2	82	0.2	3	3

DC (mm)	Głębokość otworu (L/D)	DP1020	Numer zamówieniowy	Wymiary (mm)							Typ
				LU	LCF	LH	OAL	LF	PL	DCON	
1.4	*2	●	MVS0140X02S030	3.0	7.2	10.2	55.2	55	0.2	3	1
	7	●	MVS0140X07S030	10.1	14.3	17.3	55.3	55	0.3	3	3
	12	●	MVS0140X12S030	17.1	21.3	24.3	55.3	55	0.3	3	3
	20	●	MVS0140X20S030	28.3	32.3	35.3	68.3	68	0.3	3	3
	25	●	MVS0140X25S030	35.3	39.3	42.3	74.3	74	0.3	3	3
	30	●	MVS0140X30S030	42.3	46.3	49.3	82.3	82	0.3	3	3
1.5	*2	●	MVS0150X02S030	3.2	7.6	10.4	55.2	55	0.2	3	1
	7	●	MVS0150X07S030	10.8	15.3	18.3	55.3	55	0.3	3	3
	12	●	MVS0150X12S030	18.3	23.3	26.3	55.3	55	0.3	3	3
	20	●	MVS0150X20S030	30.3	35.3	37.3	68.3	68	0.3	3	3
	25	●	MVS0150X25S030	37.8	42.3	45.3	74.3	74	0.3	3	3
	30	●	MVS0150X30S030	45.3	50.3	52.3	82.3	82	0.3	3	3
1.6	*2	●	MVS0160X02S030	3.5	8.3	10.9	68.3	68	0.3	3	1
	7	●	MVS0160X07S030	11.5	16.3	19.3	68.3	68	0.3	3	3
	12	●	MVS0160X12S030	19.5	24.3	27.3	68.3	68	0.3	3	3
	20	●	MVS0160X20S030	32.3	37.3	39.3	78.3	78	0.3	3	3
	25	●	MVS0160X25S030	40.3	45.3	47.3	86.3	86	0.3	3	3
	30	●	MVS0160X30S030	48.3	53.3	55.3	95.3	95	0.3	3	3
1.7	*2	●	MVS0170X02S030	3.7	8.7	11.1	68.3	68	0.3	3	1
	7	●	MVS0170X07S030	12.2	17.3	19.3	68.3	68	0.3	3	3
	12	●	MVS0170X12S030	20.7	26.3	28.3	68.3	68	0.3	3	3
	20	●	MVS0170X20S030	34.3	39.3	42.3	78.3	78	0.3	3	3
	25	●	MVS0170X25S030	42.8	48.3	50.3	86.3	86	0.3	3	3
	30	●	MVS0170X30S030	51.3	56.3	59.3	95.3	95	0.3	3	3

*2=Wierło pilotowe. Tolerancja: +0.014, głębokość otworu: DCx2.

● : Standard magazynowy.

DC (mm)	Głębokość otworu (L/D)	DP1020	Numer zamówieniowy	Wymiary (mm)							Typ
				LU	LCF	LH	OAL	LF	PL	DCON	
1.8	*2	●	MVS0180X02S030	3.9	9.3	11.5	68.3	68	0.3	3	1
	7	●	MVS0180X07S030	12.9	18.3	20.3	68.3	68	0.3	3	3
	12	●	MVS0180X12S030	21.9	27.3	29.3	68.3	68	0.3	3	3
	20	●	MVS0180X20S030	36.3	41.3	44.3	84.3	84	0.3	3	3
	25	●	MVS0180X25S030	45.3	50.3	53.3	94.3	94	0.3	3	3
	30	●	MVS0180X30S030	54.3	59.3	62.3	102.3	102	0.3	3	3
1.9	*2	●	MVS0190X02S030	4.1	9.7	11.8	68.3	68	0.3	3	1
	7	●	MVS0190X07S030	13.6	19.3	21.3	68.3	68	0.3	3	3
	12	●	MVS0190X12S030	23.1	29.3	31.3	68.3	68	0.3	3	3
	20	●	MVS0190X20S030	38.3	44.3	46.3	84.3	84	0.3	3	3
	25	●	MVS0190X25S030	47.8	53.3	55.3	94.3	94	0.3	3	3
	30	●	MVS0190X30S030	57.3	63.3	65.3	102.3	102	0.3	3	3
2.0	*2	●	MVS0200X02S030	4.3	10.3	12.2	68.3	68	0.3	3	1
	7	●	MVS0200X07S030	14.4	20.4	22.4	68.4	68	0.4	3	3
	12	●	MVS0200X12S030	24.4	30.4	32.4	68.4	68	0.4	3	3
	20	●	MVS0200X20S030	40.4	46.4	48.4	84.4	84	0.4	3	3
	25	●	MVS0200X25S030	50.4	56.4	58.4	94.4	94	0.4	3	3
	30	●	MVS0200X30S030	60.4	66.4	68.4	102.4	102	0.4	3	3
2.1	*2	●	MVS0210X02S030	4.5	10.7	12.4	74.3	74	0.3	3	1
	7	●	MVS0210X07S030	15.1	21.4	23.4	74.4	74	0.4	3	3
	12	●	MVS0210X12S030	25.6	32.4	34.4	74.4	74	0.4	3	3
	20	●	MVS0210X20S030	42.4	48.4	50.4	94.4	94	0.4	3	3
	25	●	MVS0210X25S030	52.9	59.4	60.4	107.4	107	0.4	3	3
	30	●	MVS0210X30S030	63.4	69.4	71.4	118.4	118	0.4	3	3
2.2	*2	●	MVS0220X02S030	4.7	11.3	12.8	74.3	74	0.3	3	1
	7	●	MVS0220X07S030	15.8	22.4	23.4	74.4	74	0.4	3	3
	12	●	MVS0220X12S030	26.8	33.4	34.4	74.4	74	0.4	3	3
	20	●	MVS0220X20S030	44.4	51.4	52.4	94.4	94	0.4	3	3
	25	●	MVS0220X25S030	55.4	62.4	63.4	107.4	107	0.4	3	3
	30	●	MVS0220X30S030	66.4	73.4	74.4	118.4	118	0.4	3	3
2.3	*2	●	MVS0230X02S030	5.0	11.8	13.1	74.4	74	0.4	3	1
	7	●	MVS0230X07S030	16.5	23.4	24.4	74.4	74	0.4	3	3
	12	●	MVS0230X12S030	28.0	35.4	36.4	74.4	74	0.4	3	3
	20	●	MVS0230X20S030	46.4	53.4	54.4	94.4	94	0.4	3	3
	25	●	MVS0230X25S030	57.9	64.4	66.4	107.4	107	0.4	3	3
	30	●	MVS0230X30S030	69.4	76.4	77.4	118.4	118	0.4	3	3
2.4	*2	●	MVS0240X02S030	5.2	12.4	13.5	74.4	74	0.4	3	1
	7	●	MVS0240X07S030	17.2	24.4	25.4	74.4	74	0.4	3	3
	12	●	MVS0240X12S030	29.2	36.4	37.4	74.4	74	0.4	3	3
	20	●	MVS0240X20S030	48.4	55.4	56.4	94.4	94	0.4	3	3
	25	●	MVS0240X25S030	60.4	67.4	68.4	107.4	107	0.4	3	3
	30	●	MVS0240X30S030	72.4	79.4	80.4	118.4	118	0.4	3	3
2.5	*2	●	MVS0250X02S030	5.4	12.8	13.7	74.4	74	0.4	3	1
	7	●	MVS0250X07S030	18.0	25.5	26.5	74.5	74	0.5	3	3
	12	●	MVS0250X12S030	30.5	38.5	39.5	74.5	74	0.5	3	3
	20	●	MVS0250X20S030	50.5	58.5	59.5	94.5	94	0.5	3	3
	25	●	MVS0250X25S030	63.0	70.5	71.5	107.5	107	0.5	3	3
	30	●	MVS0250X30S030	75.5	83.5	84.5	118.5	118	0.5	3	3

DC (mm)	Głębokość otworu (L/D)	DP1020	Numer zamówieniowy	Wymiary (mm)							Typ
				LU	LCF	LH	OAL	LF	PL	DCON	
2.6	*2	●	MVS0260X02S030	5.6	13.4	13.4	81.4	81	0.4	3	2
	7	●	MVS0260X07S030	18.7	26.5	26.5	81.5	81	0.5	3	4
	12	●	MVS0260X12S030	31.7	39.5	39.5	81.5	81	0.5	3	4
	20	●	MVS0260X20S030	52.5	60.5	60.5	103.5	103	0.5	3	4
	25	●	MVS0260X25S030	65.5	73.5	73.5	117.5	117	0.5	3	4
	30	●	MVS0260X30S030	78.5	86.5	86.5	132.5	132	0.5	3	4
2.7	*2	●	MVS0270X02S030	5.8	13.8	13.8	81.4	81	0.4	3	2
	7	●	MVS0270X07S030	19.4	27.5	27.5	81.5	81	0.5	3	4
	12	●	MVS0270X12S030	32.9	41.5	41.5	81.5	81	0.5	3	4
	20	●	MVS0270X20S030	54.5	62.5	62.5	103.5	103	0.5	3	4
	25	●	MVS0270X25S030	68.0	76.5	76.5	117.5	117	0.5	3	4
	30	●	MVS0270X30S030	81.5	89.5	89.5	132.5	132	0.5	3	4
2.8	*2	●	MVS0280X02S030	6.0	14.4	14.4	81.4	81	0.4	3	2
	7	●	MVS0280X07S030	20.1	28.5	28.5	81.5	81	0.5	3	4
	12	●	MVS0280X12S030	34.1	42.5	42.5	81.5	81	0.5	3	4
	20	●	MVS0280X20S030	56.5	64.5	64.5	103.5	103	0.5	3	4
	25	●	MVS0280X25S030	70.5	78.5	78.5	117.5	117	0.5	3	4
	30	●	MVS0280X30S030	84.5	92.5	92.5	132.5	132	0.5	3	4
2.9	*2	●	MVS0290X02S030	6.3	14.9	14.9	81.5	81	0.5	3	2
	7	●	MVS0290X07S030	20.8	29.5	29.5	81.5	81	0.5	3	4
	12	●	MVS0290X12S030	35.3	44.5	44.5	81.5	81	0.5	3	4
	20	●	MVS0290X20S030	58.5	67.5	67.5	103.5	103	0.5	3	4
	25	●	MVS0290X25S030	73.0	81.5	81.5	117.5	117	0.5	3	4
	30	●	MVS0290X30S030	87.5	96.5	96.5	132.5	132	0.5	3	4

*2=Wiertło pilotowe. Tolerancja: +0.014, głębokość otworu: DCx2.

MINI-MVS

ZALECANE PARAMETRY SKRAWANIA

Materiał przedmiotu obrabianego		P					
		Stal konstrukcyjna ($\leq 180\text{HB}$)		Stal węglowa Stal stopowa (180–280HB)		Stal węglowa Stal stopowa (280–350HB)	
Średnica wiertła DC (mm)	L/D	Obroty (min^{-1})	Posuw (min.–maks.) (mm/obr.)	Obroty (min^{-1})	Posuw (min.–maks.) (mm/obr.)	Obroty (min^{-1})	Posuw (min.–maks.) (mm/obr.)
1.0	2*,7DC	15900	0.04 (0.02–0.05)	15900	0.04 (0.02–0.05)	12700	0.04 (0.02–0.05)
	$\geq 12\text{DC}$	15900	0.02 (0.01–0.03)	12700	0.02 (0.01–0.03)	9500	0.02 (0.01–0.03)
1.5	2*,7DC	10600	0.05 (0.03–0.08)	10600	0.05 (0.03–0.08)	8400	0.05 (0.03–0.08)
	$\geq 12\text{DC}$	10600	0.05 (0.02–0.08)	8400	0.05 (0.03–0.08)	6300	0.05 (0.02–0.08)
2.0	2*,7DC	7900	0.07 (0.04–0.10)	7900	0.07 (0.04–0.10)	6300	0.07 (0.04–0.10)
	$\geq 12\text{DC}$	7900	0.07 (0.04–0.10)	7900	0.07 (0.04–0.10)	7900	0.07 (0.04–0.10)
2.5	2*,7DC	7600	0.09 (0.05–0.13)	7600	0.09 (0.05–0.13)	6300	0.09 (0.05–0.13)
	$\geq 12\text{DC}$	7600	0.09 (0.06–0.13)	6300	0.09 (0.06–0.13)	6300	0.08 (0.05–0.13)

Materiał przedmiotu obrabianego		M		K			
		Austenityczna stal nierdzewna ($\leq 200\text{HB}$)		Żeliwo szare ($\leq 350\text{MPa}$)		Żeliwo sferoidalne (GGG) ($\leq 450\text{MPa}$)	
Średnica wiertła DC (mm)	L/D	Obroty (min^{-1})	Posuw (min.–maks.) (mm/obr.)	Obroty (min^{-1})	Posuw (min.–maks.) (mm/obr.)	Obroty (min^{-1})	Posuw (min.–maks.) (mm/obr.)
1.0	2*,7DC	9500	0.03 (0.02–0.05)	15900	0.04 (0.02–0.05)	12700	0.04 (0.02–0.05)
	$\geq 12\text{DC}$	9500	0.02 (0.01–0.03)	12700	0.02 (0.01–0.03)	9500	0.02 (0.01–0.03)
1.5	2*,7DC	6300	0.05 (0.03–0.07)	10600	0.05 (0.03–0.08)	8400	0.05 (0.03–0.08)
	$\geq 12\text{DC}$	6300	0.05 (0.02–0.08)	8400	0.05 (0.03–0.08)	6300	0.05 (0.02–0.08)
2.0	2*,7DC	4700	0.06 (0.04–0.08)	7900	0.07 (0.04–0.10)	6300	0.07 (0.04–0.10)
	$\geq 12\text{DC}$	4700	0.07 (0.04–0.10)	7900	0.07 (0.04–0.10)	7900	0.07 (0.04–0.10)
2.5	2*,7DC	5000	0.08 (0.05–0.10)	7600	0.09 (0.05–0.13)	6300	0.09 (0.05–0.13)
	$\geq 12\text{DC}$	3800	0.08 (0.05–0.12)	6300	0.09 (0.06–0.13)	6300	0.08 (0.05–0.12)

Materiał przedmiotu obrabianego		N		S	
		Stopy aluminium (Si<5%)		Stop żaroodporny	
Średnica wiertła DC (mm)	L/D	Obroty (min^{-1})	Posuw (min.–maks.) (mm/obr.)	Obroty (min^{-1})	Posuw (min.–maks.) (mm/obr.)
1.0	2*,7DC	19000	0.05 (0.03–0.08)	3100	0.02 (0.01–0.03)
	$\geq 12\text{DC}$	15900	0.05 (0.03–0.08)	3100	0.02 (0.01–0.03)
1.5	2*,7DC	16900	0.07 (0.05–0.12)	2100	0.03 (0.02–0.04)
	$\geq 12\text{DC}$	14800	0.08 (0.05–0.12)	2100	0.03 (0.02–0.04)
2.0	2*,7DC	14300	0.10 (0.06–0.15)	2300	0.04 (0.03–0.05)
	$\geq 12\text{DC}$	12700	0.11 (0.06–0.15)	2300	0.04 (0.03–0.05)
2.5	2*,7DC	12700	0.13 (0.08–0.20)	1900	0.05 (0.04–0.06)
	$\geq 12\text{DC}$	11400	0.14 (0.08–0.20)	1900	0.05 (0.04–0.06)

*2=Wierłto pilotowe. Głębokość otworu DCx2.

■ WSKAZÓWKI EKSPLOATACYJNE DLA WIERTEŁ DŁUGICH TYPU MINI-MVS (L/D ≥ 10)

WIERCENIE PRZEDMIOTÓW O PŁASKIEJ POWIERZCHNI CZOŁOWEJ ● Wiercenie otworu nieprzelotowego

■ 1. Wiercenie otworu pilotowego

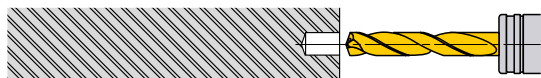

- ① Użyć wiertła o większym kącie wierzchołkowym (bardziej płaskiego), niż dla wiertła super długiego. Użyć wiertła o możliwie najkrótszym rowku wiórowym.
- ② Zapewnić wykonanie wysokodokładnego otworu pilotowego, aby proces wiercenia głębokich otworów przebiegał bez problemów
- ③ Głębokość wiercenia otworu pilotowego: ok. 1DC albo większa. (Głębokość otworu pilotowego dostosować do długości wiertła.)

■ 2. Wiercenie wstępne wiertłem długim



- ① Wiercić wstępnie otwór pilotowy przy małych obrotach. (Obroty 1000min⁻¹, posuw 0,2–0,3mm/obr)
- ② Zakończyć wiercenie wiertłem do głębokich otworów na 0,5–1mm przed dnem otworu pilotowego.

■ 3. Wiercenie głębokiego otworu

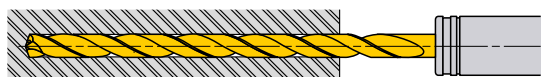

- ① Zwiększyć obroty i posuw w jednym cyklu i wiercić, aż do uzyskania żądanej głębokości otworu.

■ 4. Wycofanie wiertła



- ① Po wierceniu zmniejszyć obroty na 0,5–1mm przed końcem otworu. (Obroty około 1000min⁻¹)
- ② Wycofać wiertło na głębokość początkową otworu pilotowego przy prędkości posuwu 3000mm/min.
- ③ Wycofać wiertło z otworu pilotowego przy obrotach (n=300, Vf=3000mm/min.)

WIERCENIE PRZERYWANE ● Wiercenie otworów w płaszczyznach nieregularnych lub pod kątem

■ 1. Frezowanie pogłębienia prostopadłego do kierunku wiercenia



- ① Obrabiać płaską lub nieregularną powierzchnię frezem palcowym lub frezem do rowków wpustowych o tej samej średnicy, jak wymagana średnica otworu.

■ 2. Wiercenie otworu pilotowego



- ① Użyć wiertła o większym kącie wierzchołkowym (bardziej płaskiego), niż dla wiertła super długiego. Użyć wiertła o możliwie najkrótszym rowku wiórowym.
- ② Zapewnić wykonanie wysokodokładnego otworu pilotowego, aby proces wiercenia głębokich otworów przebiegał bez problemów
- ③ Głębokość wiercenia otworu pilotowego: ok. 1DC albo większa. (Głębokość otworu pilotowego dostosować do długości wiertła.)

■ 3. Wiercenie wstępne wiertłem długim



- ① Wprowadzić wiertło w otwór pilotowy przy małych obrotach (prędkość skrawania 20–30m/min, posuw 0,2–0,3 mm/obr).
- ② Zatrzymać wiertło 1mm–3 mm przed dnem otworu pilotowego.

■ 4. Wiercenie głębokiego otworu

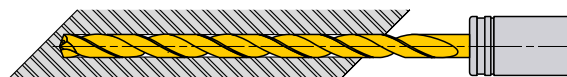

- ① Zwiększyć obroty i posuw w jednym cyklu i wiercić, aż do uzyskania żądanej głębokości otworu.

■ 5. Wyjście z materiału

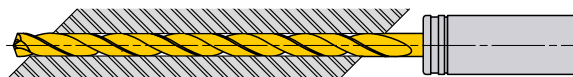

- ① Podczas wychodzenia z materiału istnieje niebezpieczeństwo uszkodzenia krawędzi skrawającej wiertła.
- ② W momencie wyjścia z materiału zmniejszyć posuw.

■ 6. Wycofanie wiertła



- ① Wycofać wiertło do punktu początkowego otworu pilotowego przy prędkości posuwu 3000mm/min.

WIERCENIE (WIERTŁA PEŁNOWĘGLIKOWE)

MINI-MWS

- Mikrowiertła z przelotowym kanałem chłodziwa do stabilnego wiercenia głębokich otworów.
- Stosowane do wysokowydajnego i dokładnego wiercenia stali zwykłej i materiałów trudnoobrabialnych.



WĘGLIKI
SPIEKANE

WIERCENIE

M



Chłodzenie wewnętrzne

Typ SB

(Do wiercenia otworów pilotowych)

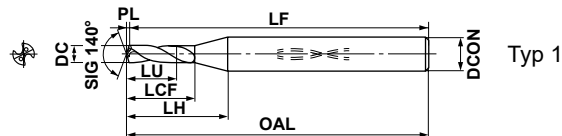

	$0.5 \leq DC < 1$
	+0.009
	0
	0
	-0.006

Typ LB/XB

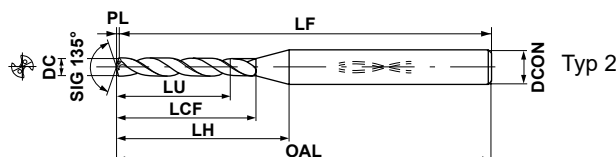

	$0.5 \leq DC < 1$
	0
	-0.009
	0
	-0.006

- Wiertła MWS można stosować z oprawkami termokurczliwymi.

DC (mm)	Głębokość otworu (L/D)	VP15TF	Numer zamówieniowy	Wymiary (mm)							Typ
				LU	LCF	LH	OAL	LF	PL	DCON	
0.50	1	●	MWS0050SB	0.6	2.6	7.3	47.1	47	0.09	3	1
	5	★	MWS0050LB	2.6	8.1	13.1	47.1	47	0.10	3	2
	12	★	MWS0050XB	6.1	16.1	21.1	47.1	47	0.10	3	2
0.51	1	★	MWS0051SB	0.6	2.7	7.3	47.1	47	0.09	3	1
	5	★	MWS0051LB	2.7	8.1	13.1	47.1	47	0.11	3	2
	12	★	MWS0051XB	6.2	16.1	21.1	47.1	47	0.11	3	2
0.52	1	★	MWS0052SB	0.6	2.7	7.3	47.1	47	0.09	3	1
	5	★	MWS0052LB	2.7	8.1	13.1	47.1	47	0.11	3	2
	12	★	MWS0052XB	6.4	16.1	21.1	47.1	47	0.11	3	2
0.53	1	★	MWS0053SB	0.6	2.7	7.3	47.1	47	0.10	3	1
	5	★	MWS0053LB	2.8	8.1	13.1	47.1	47	0.11	3	2
	12	★	MWS0053XB	6.5	16.1	21.1	47.1	47	0.11	3	2
0.54	1	★	MWS0054SB	0.6	2.7	7.3	47.1	47	0.10	3	1
	5	★	MWS0054LB	2.8	8.1	13.1	47.1	47	0.11	3	2
	12	★	MWS0054XB	6.6	16.1	21.1	47.1	47	0.11	3	2
0.55	1	●	MWS0055SB	0.7	2.7	7.3	47.1	47	0.10	3	1
	5	★	MWS0055LB	2.9	8.1	13.1	47.1	47	0.11	3	2
	12	★	MWS0055XB	6.7	16.1	21.1	47.1	47	0.11	3	2
0.56	1	★	MWS0056SB	0.7	3.0	7.6	47.1	47	0.10	3	1
	5	★	MWS0056LB	2.9	8.1	13.1	47.1	47	0.12	3	2
	12	★	MWS0056XB	6.8	16.1	21.1	47.1	47	0.12	3	2
0.57	1	★	MWS0057SB	0.7	3.0	7.5	47.1	47	0.10	3	1
	5	★	MWS0057LB	3.0	8.1	13.1	47.1	47	0.12	3	2
	12	★	MWS0057XB	7.0	16.1	21.1	47.1	47	0.12	3	2

DC (mm)	Głębokość otworu (L/D)	VP15TF	Numer zamówieniowy	Wymiary (mm)							Typ
				LU	LCF	LH	OAL	LF	PL	DCON	
0.58	1	★	MWS0058SB	0.7	3.0	7.5	47.1	47	0.11	3	1
	5	★	MWS0058LB	3.0	8.1	13.1	47.1	47	0.12	3	2
	12	★	MWS0058XB	7.1	16.1	21.1	47.1	47	0.12	3	2
0.59	1	★	MWS0059SB	0.7	3.0	7.5	47.1	47	0.11	3	1
	5	★	MWS0059LB	3.1	8.1	12.1	47.1	47	0.12	3	2
	12	★	MWS0059XB	7.2	16.1	20.1	47.1	47	0.12	3	2
0.60	1	●	MWS0060SB	0.7	3.0	7.5	47.1	47	0.11	3	1
	5	★	MWS0060LB	3.1	8.1	12.1	47.1	47	0.12	3	2
	12	★	MWS0060XB	7.3	16.1	20.1	47.1	47	0.12	3	2
0.61	1	★	MWS0061SB	0.7	3.2	7.7	47.1	47	0.11	3	1
	5	★	MWS0061LB	3.2	8.1	12.1	47.1	47	0.13	3	2
	12	★	MWS0061XB	7.5	16.1	20.1	47.1	47	0.13	3	2
0.62	1	★	MWS0062SB	0.7	3.2	7.6	47.1	47	0.11	3	1
	5	★	MWS0062LB	3.2	8.1	12.1	47.1	47	0.13	3	2
	12	★	MWS0062XB	7.6	16.1	20.1	47.1	47	0.13	3	2
0.63	1	★	MWS0063SB	0.7	3.2	7.6	47.1	47	0.11	3	1
	5	★	MWS0063LB	3.3	8.1	12.1	47.1	47	0.13	3	2
	12	★	MWS0063XB	7.7	16.1	20.1	47.1	47	0.13	3	2
0.64	1	★	MWS0064SB	0.8	3.2	7.6	47.1	47	0.12	3	1
	5	★	MWS0064LB	3.3	8.1	12.1	47.1	47	0.13	3	2
	12	★	MWS0064XB	7.8	16.1	20.1	47.1	47	0.13	3	2
0.65	1	●	MWS0065SB	0.8	3.2	7.6	47.1	47	0.12	3	1
	5	★	MWS0065LB	3.4	8.1	12.1	47.1	47	0.13	3	2
	12	★	MWS0065XB	7.9	16.1	20.1	47.1	47	0.13	3	2

Uwaga 1) Gdy geometria wiertła nie odpowiada wartościom podanym w tabeli (np. inna średnica i długość wiertła), prosimy o skontaktowanie się z naszą firmą.

- : Standard magazynowy. ★ : Na specjalne zamówienie z magazynu w Japonii.

DC (mm)	Głębokość otworu (L/D)	VP15TF	Numer zamówieniowy	Wymiary (mm)							Typ
				LU	LCF	LH	OAL	LF	PL	DCON	
0.66	1	★	MWS0066SB	0.8	3.5	7.9	47.1	47	0.12	3	1
	5	★	MWS0066LB	3.4	8.1	12.1	47.1	47	0.14	3	2
	12	★	MWS0066XB	8.1	16.1	20.1	47.1	47	0.14	3	2
0.67	1	★	MWS0067SB	0.8	3.5	7.8	47.1	47	0.12	3	1
	5	★	MWS0067LB	3.5	8.1	12.1	47.1	47	0.14	3	2
	12	★	MWS0067XB	8.2	16.1	20.1	47.1	47	0.14	3	2
0.68	1	★	MWS0068SB	0.8	3.5	7.8	47.1	47	0.12	3	1
	5	★	MWS0068LB	3.5	8.1	12.1	47.1	47	0.14	3	2
	12	★	MWS0068XB	8.3	16.1	20.1	47.1	47	0.14	3	2
0.69	1	★	MWS0069SB	0.8	3.5	7.8	47.1	47	0.13	3	1
	5	★	MWS0069LB	3.6	8.1	12.1	47.1	47	0.14	3	2
	12	★	MWS0069XB	8.4	16.1	20.1	47.1	47	0.14	3	2
0.70	1	●	MWS0070SB	0.8	3.5	7.8	47.1	47	0.13	3	1
	5	★	MWS0070LB	3.6	8.1	12.1	47.1	47	0.14	3	2
	12	★	MWS0070XB	8.5	16.1	20.1	47.1	47	0.14	3	2
0.71	1	★	MWS0071SB	0.8	3.7	8.0	50.1	50	0.13	3	1
	5	★	MWS0071LB	3.7	10.1	14.1	50.1	50	0.15	3	2
	12	★	MWS0071XB	8.7	20.1	24.1	50.1	50	0.15	3	2
0.72	1	★	MWS0072SB	0.9	3.7	8.0	50.1	50	0.13	3	1
	5	★	MWS0072LB	3.8	10.1	14.1	50.1	50	0.15	3	2
	12	★	MWS0072XB	8.8	20.1	24.1	50.1	50	0.15	3	2
0.73	1	★	MWS0073SB	0.9	3.7	7.9	50.1	50	0.13	3	1
	5	★	MWS0073LB	3.8	10.1	14.1	50.1	50	0.15	3	2
	12	★	MWS0073XB	8.9	20.1	24.1	50.1	50	0.15	3	2
0.74	1	★	MWS0074SB	0.9	3.7	7.9	50.1	50	0.13	3	1
	5	★	MWS0074LB	3.9	10.1	14.1	50.1	50	0.15	3	2
	12	★	MWS0074XB	9.0	20.1	24.1	50.1	50	0.15	3	2
0.75	1	●	MWS0075SB	0.9	3.7	7.9	50.1	50	0.14	3	1
	5	★	MWS0075LB	3.9	10.1	14.1	50.1	50	0.16	3	2
	12	★	MWS0075XB	9.2	20.1	24.1	50.1	50	0.16	3	2
0.76	1	★	MWS0076SB	0.9	4.0	8.2	50.1	50	0.14	3	1
	5	★	MWS0076LB	4.0	10.1	14.1	50.1	50	0.16	3	2
	12	★	MWS0076XB	9.3	20.1	24.1	50.1	50	0.16	3	2
0.77	1	★	MWS0077SB	0.9	4.0	8.2	50.1	50	0.14	3	1
	5	★	MWS0077LB	4.0	10.1	14.1	50.1	50	0.16	3	2
	12	★	MWS0077XB	9.4	20.1	24.1	50.1	50	0.16	3	2
0.78	1	★	MWS0078SB	0.9	4.0	8.1	50.1	50	0.14	3	1
	5	★	MWS0078LB	4.1	10.1	14.1	50.1	50	0.16	3	2
	12	★	MWS0078XB	9.5	20.1	24.1	50.1	50	0.16	3	2
0.79	1	★	MWS0079SB	0.9	4.0	8.1	50.1	50	0.14	3	1
	5	★	MWS0079LB	4.1	10.1	14.1	50.1	50	0.16	3	2
	12	★	MWS0079XB	9.6	20.1	24.1	50.1	50	0.16	3	2
0.80	1	●	MWS0080SB	1.0	4.1	8.2	50.2	50	0.15	3	1
	5	★	MWS0080LB	4.2	10.2	14.2	50.2	50	0.17	3	2
	12	★	MWS0080XB	9.8	20.2	24.2	50.2	50	0.17	3	2
0.81	1	★	MWS0081SB	1.0	4.3	8.4	50.2	50	0.15	3	1
	5	★	MWS0081LB	4.2	10.2	14.2	50.2	50	0.17	3	2
	12	★	MWS0081XB	9.9	20.2	24.2	50.2	50	0.17	3	2
0.82	1	★	MWS0082SB	1.0	4.3	8.4	50.2	50	0.15	3	1
	5	★	MWS0082LB	4.3	10.2	14.2	50.2	50	0.17	3	2
	12	★	MWS0082XB	10.0	20.2	24.2	50.2	50	0.17	3	2

DC (mm)	Głębokość otworu (L/D)	VP15TF	Numer zamówieniowy	Wymiary (mm)							Typ
				LU	LCF	LH	OAL	LF	PL	DCON	
0.83	1	★	MWS0083SB	1.0	4.3	8.3	50.2	50	0.15	3	1
	5	★	MWS0083LB	4.3	10.2	14.2	50.2	50	0.17	3	2
	12	★	MWS0083XB	10.1	20.2	24.2	50.2	50	0.17	3	2
0.84	1	★	MWS0084SB	1.0	4.3	8.3	50.2	50	0.15	3	1
	5	★	MWS0084LB	4.4	10.2	14.2	50.2	50	0.17	3	2
	12	★	MWS0084XB	10.3	20.2	24.2	50.2	50	0.17	3	2
0.85	1	●	MWS0085SB	1.0	4.3	8.3	50.2	50	0.15	3	1
	5	★	MWS0085LB	4.4	10.2	14.2	50.2	50	0.18	3	2
	12	★	MWS0085XB	10.4	20.2	24.2	50.2	50	0.18	3	2
0.86	1	★	MWS0086SB	1.0	4.6	8.6	50.2	50	0.16	3	1
	5	★	MWS0086LB	4.5	10.2	14.2	50.2	50	0.18	3	2
	12	★	MWS0086XB	10.5	20.2	24.2	50.2	50	0.18	3	2
0.87	1	★	MWS0087SB	1.0	4.6	8.6	50.2	50	0.16	3	1
	5	★	MWS0087LB	4.5	10.2	14.2	50.2	50	0.18	3	2
	12	★	MWS0087XB	10.6	20.2	24.2	50.2	50	0.18	3	2
0.88	1	★	MWS0088SB	1.0	4.6	8.6	50.2	50	0.16	3	1
	5	★	MWS0088LB	4.6	10.2	14.2	50.2	50	0.18	3	2
	12	★	MWS0088XB	10.7	20.2	24.2	50.2	50	0.18	3	2
0.89	1	★	MWS0089SB	1.1	4.6	8.5	50.2	50	0.16	3	1
	5	★	MWS0089LB	4.6	10.2	14.2	50.2	50	0.18	3	2
	12	★	MWS0089XB	10.9	20.2	24.2	50.2	50	0.18	3	2
0.90	1	●	MWS0090SB	1.1	4.6	8.5	50.2	50	0.16	3	1
	5	★	MWS0090LB	4.7	10.2	14.2	50.2	50	0.19	3	2
	12	★	MWS0090XB	11.0	20.2	24.2	50.2	50	0.19	3	2
0.91	1	★	MWS0091SB	1.1	4.8	8.7	50.2	50	0.17	3	1
	5	★	MWS0091LB	4.7	10.2	14.2	50.2	50	0.19	3	2
	12	★	MWS0091XB	11.1	20.2	24.2	50.2	50	0.19	3	2
0.92	1	★	MWS0092SB	1.1	4.8	8.7	50.2	50	0.17	3	1
	5	★	MWS0092LB	4.8	10.2	14.2	50.2	50	0.19	3	2
	12	★	MWS0092XB	11.2	20.2	24.2	50.2	50	0.19	3	2
0.93	1	★	MWS0093SB	1.1	4.8	8.7	50.2	50	0.17	3	1
	5	★	MWS0093LB	4.8	10.2	14.2	50.2	50	0.19	3	2
	12	★	MWS0093XB	11.4	20.2	24.2	50.2	50	0.19	3	2
0.94	1	★	MWS0094SB	1.1	4.8	8.6	50.2	50	0.17	3	1
	5	★	MWS0094LB	4.9	10.2	14.2	50.2	50	0.19	3	2
	12	★	MWS0094XB	11.5	20.2	24.2	50.2	50	0.19	3	2
0.95	1	●	MWS0095SB	1.1	4.8	8.6	50.2	50	0.17	3	1
	5	★	MWS0095LB	5.0	10.2	14.2	50.2	50	0.20	3	2
	12	★	MWS0095XB	11.6	20.2	24.2	50.2	50	0.20	3	2
0.96	1	★	MWS0096SB	1.1	5.1	8.9	50.2	50	0.17	3	1
	5	★	MWS0096LB	5.0	10.2	14.2	50.2	50	0.20	3	2
	12	★	MWS0096XB	11.7	20.2	24.2	50.2	50	0.20	3	2
0.97	1	★	MWS0097SB	1.2	5.1	8.9	50.2	50	0.18	3	1
	5	★	MWS0097LB	5.1	10.2	14.2	50.2	50	0.20	3	2
	12	★	MWS0097XB	11.8	20.2	24.2	50.2	50	0.20	3	2
0.98	1	★	MWS0098SB	1.2	5.1	8.9	50.2	50	0.18	3	1
	5	★	MWS0098LB	5.1	10.2	14.2	50.2	50	0.20	3	2
	12	★	MWS0098XB	12.0	20.2	24.2	50.2	50	0.20	3	2
0.99	1	★	MWS0099SB	1.2	5.1	8.9	50.2	50	0.18	3	1
	5	★	MWS0099LB	5.2	10.2	14.2	50.2	50	0.21	3	2
	12	★	MWS0099XB	12.1	20.2	24.2	50.2	50	0.21	3	2

Uwaga 1) Gdy geometria wiertła nie odpowiada wartościom podanym w tabeli (np. inna średnica i długość wiertła), prosimy o skontaktowanie się z naszą firmą.

MINI-MWS

ZALECANE PARAMETRY SKRAWANIA

Wiertła typu SB/LB/XB (L/D<10)



Materiał przedmiotu obrabianego	P							
	Stal konstrukcyjna ($\leq 180\text{HB}$) Ck10				Stal węglowa, Stal stopowa (180–280HB) Ck45, 42CrMo4			
Średnica wiertła DC (mm)	Prędkość skrawania (m/min)	Obroty (min^{-1})	Posuw (min.–maks.) (mm/obr.)	Posuw stołu (mm/min)	Prędkość skrawania (m/min)	Obroty (min^{-1})	Posuw (min.–maks.) (mm/obr.)	Posuw stołu (mm/min)
0.5	40	25400	0.010 (0.005–0.015)	250	40	25400	0.010 (0.005–0.015)	250
0.63	40	20200	0.014 (0.008–0.020)	280	40	20200	0.014 (0.008–0.020)	280
0.8	45	17900	0.028 (0.016–0.040)	500	45	17900	0.028 (0.016–0.040)	500
1.0	50	15900	0.035 (0.020–0.050)	555	50	15900	0.035 (0.020–0.050)	555

Materiał przedmiotu obrabianego	P				M			
	Stal węglowa, Stal stopowa (280–350HB) 36CrNiMo4				Austenityczna stal nierdzewna ($\leq 200\text{HB}$) X5CrNi1810, X5CrNiMo17-12-2			
Średnica wiertła DC (mm)	Prędkość skrawania (m/min)	Obroty (min^{-1})	Posuw (min.–maks.) (mm/obr.)	Posuw stołu (mm/min)	Prędkość skrawania (m/min)	Obroty (min^{-1})	Posuw (min.–maks.) (mm/obr.)	Posuw stołu (mm/min)
0.5	30	19000	0.010 (0.005–0.015)	190	20	12700	0.008 (0.005–0.010)	100
0.63	30	15100	0.014 (0.008–0.020)	210	20	10100	0.010 (0.008–0.013)	100
0.8	35	13900	0.028 (0.016–0.040)	385	25	9900	0.020 (0.016–0.026)	195
1.0	40	12700	0.035 (0.020–0.050)	440	30	9500	0.030 (0.020–0.044)	285

Materiał przedmiotu obrabianego	K							
	Żeliwo szare ($\leq 350\text{MPa}$) GG30				Żeliwo sferoidalne (GGG) ($\leq 450\text{MPa}$) GGG45			
Średnica wiertła DC (mm)	Prędkość skrawania (m/min)	Obroty (min^{-1})	Posuw (min.–maks.) (mm/obr.)	Posuw stołu (mm/min)	Prędkość skrawania (m/min)	Obroty (min^{-1})	Posuw (min.–maks.) (mm/obr.)	Posuw stołu (mm/min)
0.5	40	25400	0.010 (0.005–0.015)	250	30	19000	0.010 (0.005–0.015)	190
0.63	40	20200	0.014 (0.008–0.020)	280	30	15100	0.014 (0.008–0.020)	210
0.8	45	17900	0.028 (0.016–0.040)	500	35	13900	0.028 (0.016–0.040)	385
1.0	50	15900	0.035 (0.020–0.050)	555	40	12700	0.035 (0.020–0.050)	440

Materiał przedmiotu obrabianego	N				S			
	Stopy aluminium (Si<5%)				Stopy żaroodporne Inconel718			
Średnica wiertła DC (mm)	Prędkość skrawania (m/min)	Obroty (min^{-1})	Posuw (min.–maks.) (mm/obr.)	Posuw stołu (mm/min)	Prędkość skrawania (m/min)	Obroty (min^{-1})	Posuw (min.–maks.) (mm/obr.)	Posuw stołu (mm/min)
0.5	40	25400	0.014 (0.008–0.020)	355	10	6300	0.006 (0.004–0.008)	35
0.63	40	20200	0.020 (0.012–0.030)	400	10	5000	0.008 (0.007–0.010)	40
0.8	45	17900	0.036 (0.024–0.050)	640	10	3900	0.016 (0.013–0.021)	60
1.0	60	19000	0.050 (0.030–0.075)	950	10	3100	0.020 (0.016–0.027)	60

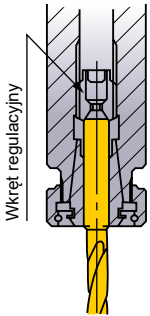
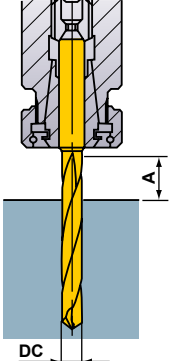
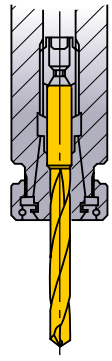
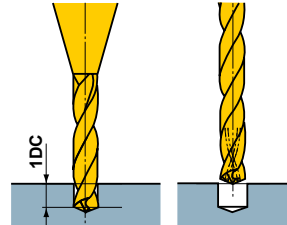
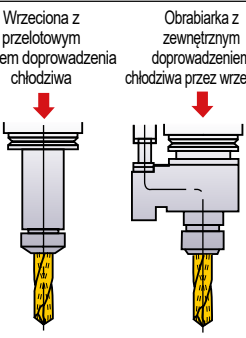
WSKAZÓWKI EKSPLOATACYJNE

<p>Zamocowanie wiertła</p>  <p>Uchwyt z tuleją wciągana i łożyskiem oporowym silnie mocuje narzędzie.</p>	<p>Długość wiertła</p>  <p>$A \geq DC \times 2.0$</p>	<p>Montaż wiertła</p>  <p>Nie mocować wiertła za rowek wiórowy.</p>	<p>Montaż wiertła</p>  <p>① Do otworu wstępnego zalecane wiertło typu SB. ② Podczas wiercenia wiertłem z kanałem doprowadzenia chłodziwa, przygotowany wcześniej otwór wykorzystać jako otwór prowadzący. W zależności od parametrów skrawania zaleca się wiercenie z posuwem stopniowym (z wycofaniem wiertła).</p>
<p>Typ z przelotowym kanałem doprowadzenia chłodziwa</p>  <p>Wrzeciona z przelotowym kanałem doprowadzenia chłodziwa Obrabiarka z zewnętrznym doprowadzeniem chłodziwa przez wrzeciono</p> <p>Zalecane ciśnienie chłodziwa: ≥ 30 bar Ciśnienie minimalne: 15 bar</p>	<p>Cienkie przedmioty obrabiane</p>  <p>Umieścić przedmiot obrabiany na podpórcie OK</p> <p>W razie wystąpienia zginania X</p>	<p>Postępowanie z chłodziwem</p> <ol style="list-style-type: none"> 1) W wiertłach o małej średnicy drobny wiór zatyka kanał doprowadzenia chłodziwa. Profilaktycznie zawsze należy używać dokładnego filtra. 2) Częstki brudu i kurzu w używanym chłodziwie przylegają do kanału doprowadzenia chłodziwa i uniemożliwiają skuteczny przepływ. Zalecana jest regularna wymiana chłodziwa. 	

UWAGI EKSPLOATACYJNE

- Do czyszczenia chłodziwa używać filtra o małym numerze sita ($\leq 5\mu m$), aby zapobiec zatkaniu kanału doprowadzenia chłodziwa.

WIERCENIE (WIERTŁA PEŁNOWĘGLIKOWE)

MPS1

Wiertła z podwójną łysinką i wiertła super długie

- Nowa wielowarstwowa powłoka PVD bazowana na specjalnym kompozycje Al-Ti-Cr-N.
- MPS1 to typ wiertła z podwójną łysinką, co umożliwia dokładną obróbkę.



L/D=2
PC
L/D=3-5
L/D=10-40
L/D=8



Chłodzenie wewnętrzne



● **Typ 1** Typ z chwytem walcowym ze stożkową szyjką

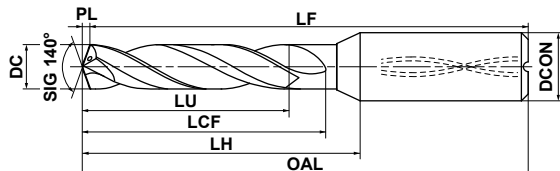

MPS1----S/L-DIN-C/L8C-L40C

● **Typ 3** Chwył Whistle-Notch ze stożkową szyjką

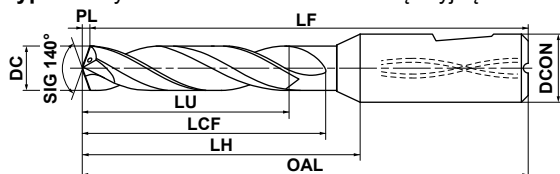

MPS1----S/L-DIN (Whistle notch)



	3≤DC≤6	6<DC≤10	10<DC≤18	18<DC≤20
DIN / PC	+0.010 -0.002	+0.010 -0.005	+0.005 -0.013	+0.005 -0.016
L___C	0 -0.012	0 -0.015	0 -0.018	0 -0.021
h6	0 -0.008	0 -0.009	0 -0.011	0 -0.013

*Otwór chłodziwa o średnicy ø4,9 mm lub mniejszej będzie okrągły.
*SIG : L/D 3-5 i 10-40 = 140°, 8 = 135°, PC = 145°

● **Typ 2** Typ z chwytem walcowym

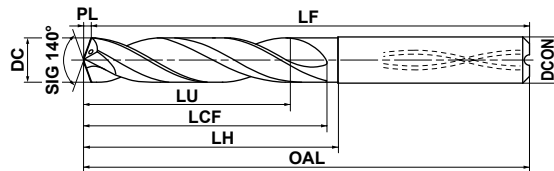

MPS1----S/L-DIN-C/L8C-L40C

● **Typ 4** Chwył Whistle-Notch

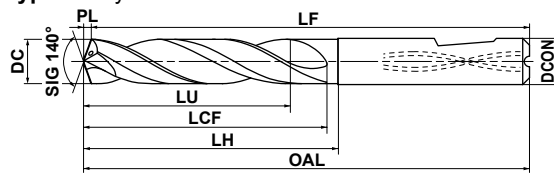

MPS1----S/L-DIN (Whistle notch)

DC (mm)	Głębokość otworu (L/D)	DP1021	Numer zamówieniowy	Wymiary (mm)						Typ		
				LU	LCF	LH	OAL	LF	PL		DCON	
3.0	3	□	MPS1-0300S-DIN	15.0	19.5	24.5	61.5	61	0.5	6	3	
	3	●	MPS1-0300S-DIN-C	15.0	19.5	24.5	61.5	61	0.5	6	1	
	5	□	MPS1-0300L-DIN	20.0	24.5	28.5	65.5	65	0.5	6	3	
	5	●	MPS1-0300L-DIN-C	20.0	24.5	28.5	65.5	65	0.5	6	1	
	2	●	MPS1-0300-PC	6.5	16.5	19.7	55.5	55	0.5	6	1	
	8	●	MPS1-0300-L8C	24.6	33.6	39.6	76.6	76	0.6	6	1	
	10	●	MPS1-0300-L10C	30.5	37.5	42.5	79.5	79	0.5	6	1	
	12	●	MPS1-0300-L12C	36.5	43.5	48.5	85.5	85	0.5	6	1	
	15	●	MPS1-0300-L15C	45.5	52.5	57.5	94.5	94	0.5	6	1	
	20	●	MPS1-0300-L20C	60.5	67.5	72.5	109.5	109	0.5	6	1	
3.05	25	●	MPS1-0300-L25C	75.5	82.5	87.5	124.5	124	0.5	6	1	
	30	●	MPS1-0300-L30C	90.5	97.5	102.5	139.5	139	0.5	6	1	
	35	□	MPS1-0300-L35C	105.5	113.5	121.5	158.5	158	0.5	6	1	
	40	●	MPS1-0300-L40C	120.5	128.5	136.5	173.5	173	0.5	6	1	
	3	□	MPS1-0305S-DIN	15.0	19.6	24.6	61.6	61	0.6	6	3	
	3	●	MPS1-0305S-DIN-C	15.0	19.6	24.6	61.6	61	0.6	6	1	
	5	□	MPS1-0305L-DIN	20.0	24.6	28.6	65.6	65	0.6	6	3	
	5	●	MPS1-0305L-DIN-C	20.0	24.6	28.6	65.6	65	0.6	6	1	
	3.1	3	□	MPS1-0310S-DIN	14.9	19.6	24.6	61.6	61	0.6	6	3
		3	●	MPS1-0310S-DIN-C	14.9	19.6	24.6	61.6	61	0.6	6	1
5		□	MPS1-0310L-DIN	19.9	24.6	28.6	65.6	65	0.6	6	3	
5		●	MPS1-0310L-DIN-C	19.9	24.6	28.6	65.6	65	0.6	6	1	
2		●	MPS1-0310-PC	6.7	18.5	21.6	55.5	55	0.5	6	1	
8		●	MPS1-0310-L8C	25.4	39.6	45.6	82.6	82	0.6	6	1	
10		□	MPS1-0310-L10C	31.6	44.6	49.6	86.6	86	0.6	6	1	
12		●	MPS1-0310-L12C	37.8	51.6	56.6	93.6	93	0.6	6	1	
15		●	MPS1-0310-L15C	47.1	61.6	66.6	103.6	103	0.6	6	1	
20		●	MPS1-0310-L20C	62.6	79.6	84.6	121.6	121	0.6	6	1	
3.3	25	●	MPS1-0310-L25C	78.1	96.6	101.6	138.6	138	0.6	6	1	
	30	●	MPS1-0310-L30C	93.6	114.6	119.6	156.6	156	0.6	6	1	
	35	□	MPS1-0310-L35C	109.1	123.6	138.6	175.6	175	0.6	6	1	
	40	●	MPS1-0310-L40C	124.6	138.6	153.6	190.6	190	0.6	6	1	

DC (mm)	Głębokość otworu (L/D)	DP1021	Numer zamówieniowy	Wymiary (mm)						Typ	
				LU	LCF	LH	OAL	LF	PL		DCON
3.2	3	□	MPS1-0320S-DIN	14.8	19.6	24.6	61.6	61	0.6	6	3
	3	●	MPS1-0320S-DIN-C	14.8	19.6	24.6	61.6	61	0.6	6	1
	5	□	MPS1-0320L-DIN	19.8	24.6	28.6	65.6	65	0.6	6	3
	5	●	MPS1-0320L-DIN-C	19.8	24.6	28.6	65.6	65	0.6	6	1
	2	●	MPS1-0320-PC	6.9	18.5	21.5	55.5	55	0.5	6	1
	8	●	MPS1-0320-L8C	26.3	39.7	45.7	82.7	82	0.7	6	1
	10	□	MPS1-0320-L10C	32.6	44.6	49.6	86.6	86	0.6	6	1
	12	●	MPS1-0320-L12C	39.0	51.6	56.6	93.6	93	0.6	6	1
	15	●	MPS1-0320-L15C	48.6	61.6	66.6	103.6	103	0.6	6	1
	20	●	MPS1-0320-L20C	64.6	79.6	84.6	121.6	121	0.6	6	1
3.3	25	●	MPS1-0320-L25C	80.6	96.6	101.6	138.6	138	0.6	6	1
	30	●	MPS1-0320-L30C	96.6	114.6	119.6	156.6	156	0.6	6	1
	35	□	MPS1-0320-L35C	112.6	123.6	138.6	175.6	175	0.6	6	1
	40	●	MPS1-0320-L40C	128.6	138.6	153.6	190.6	190	0.6	6	1
	3	□	MPS1-0330S-DIN	14.7	19.6	24.6	61.6	61	0.6	6	3
	3	●	MPS1-0330S-DIN-C	14.7	19.6	24.6	61.6	61	0.6	6	1
	5	□	MPS1-0330L-DIN	20.2	25.1	28.6	65.6	65	0.6	6	3
	5	●	MPS1-0330L-DIN-C	20.2	25.1	28.6	65.6	65	0.6	6	1
	2	●	MPS1-0330-PC	7.1	18.5	21.4	55.5	55	0.5	6	1
	8	●	MPS1-0330-L8C	27.1	39.7	45.7	82.7	82	0.7	6	1
10	□	MPS1-0330-L10C	33.6	44.6	49.6	86.6	86	0.6	6	1	
12	●	MPS1-0330-L12C	40.2	51.6	56.6	93.6	93	0.6	6	1	
15	●	MPS1-0330-L15C	50.1	61.6	66.6	103.6	103	0.6	6	1	
20	●	MPS1-0330-L20C	66.6	79.6	84.6	121.6	121	0.6	6	1	
25	●	MPS1-0330-L25C	83.1	96.6	101.6	138.6	138	0.6	6	1	
30	●	MPS1-0330-L30C	99.6	114.6	119.6	156.6	156	0.6	6	1	
35	□	MPS1-0330-L35C	116.1	132.6	138.6	175.6	175	0.6	6	1	
40	●	MPS1-0330-L40C	132.6	148.6	153.6	190.6	190	0.6	6	1	

● : Standard magazynowy. □ : Niestandardowy, produkowany na specjalne zamówienie.

DC (mm)	Głębokość otworu (L/D)	DP1021	Numer zamówieniowy	Wymiary (mm)								Typ
				LU	LCF	LH	OAL	LF	PL	DCON		
3.4	3	□	MPS1-0340S-DIN	14.5	19.6	24.6	61.6	61	0.6	6	3	
	3	●	MPS1-0340S-DIN-C	14.5	19.6	24.6	61.6	61	0.6	6	1	
	5	□	MPS1-0340L-DIN	20.0	25.1	28.6	65.6	65	0.6	6	3	
	5	●	MPS1-0340L-DIN-C	20.0	25.1	28.6	65.6	65	0.6	6	1	
	2	●	MPS1-0340-PC	7.3	18.5	21.3	55.5	55	0.5	6	1	
	8	●	MPS1-0340-L8C	27.9	39.7	45.7	82.7	82	0.7	6	1	
	10	□	MPS1-0340-L10C	34.6	44.6	49.6	86.6	86	0.6	6	1	
	12	●	MPS1-0340-L12C	41.4	51.6	56.6	93.6	93	0.6	6	1	
	15	●	MPS1-0340-L15C	51.6	61.6	66.6	103.6	103	0.6	6	1	
	20	●	MPS1-0340-L20C	68.6	79.6	84.6	121.6	121	0.6	6	1	
	25	●	MPS1-0340-L25C	85.6	96.6	101.6	138.6	138	0.6	6	1	
	30	●	MPS1-0340-L30C	102.6	114.6	119.6	156.6	156	0.6	6	1	
	35	□	MPS1-0340-L35C	119.6	132.6	138.6	175.6	175	0.6	6	1	
	40	●	MPS1-0340-L40C	136.6	148.6	153.6	190.6	190	0.6	6	1	
3.5	3	□	MPS1-0350S-DIN	14.4	19.6	24.6	61.6	61	0.6	6	3	
	3	●	MPS1-0350S-DIN-C	14.4	19.6	24.6	61.6	61	0.6	6	1	
	5	□	MPS1-0350L-DIN	19.9	25.1	28.6	65.6	65	0.6	6	3	
	5	●	MPS1-0350L-DIN-C	19.9	25.1	28.6	65.6	65	0.6	6	1	
	2	●	MPS1-0350-PC	7.6	18.6	21.2	55.6	55	0.6	6	1	
	8	●	MPS1-0350-L8C	28.7	39.7	45.7	82.7	82	0.7	6	1	
	10	□	MPS1-0350-L10C	35.6	44.6	49.6	86.6	86	0.6	6	1	
	12	●	MPS1-0350-L12C	42.6	51.6	56.6	93.6	93	0.6	6	1	
	15	●	MPS1-0350-L15C	53.1	61.6	66.6	103.6	103	0.6	6	1	
	20	●	MPS1-0350-L20C	70.6	79.6	84.6	121.6	121	0.6	6	1	
	25	●	MPS1-0350-L25C	88.1	96.6	101.6	138.6	138	0.6	6	1	
	30	●	MPS1-0350-L30C	105.6	114.6	119.6	156.6	156	0.6	6	1	
	35	□	MPS1-0350-L35C	123.1	132.6	138.6	175.6	175	0.6	6	1	
	40	●	MPS1-0350-L40C	140.6	148.6	153.6	190.6	190	0.6	6	1	
3.6	3	□	MPS1-0360S-DIN	14.3	19.7	24.7	61.7	61	0.7	6	3	
	3	●	MPS1-0360S-DIN-C	14.3	19.7	24.7	61.7	61	0.7	6	1	
	5	□	MPS1-0360L-DIN	19.8	25.2	28.7	65.7	65	0.7	6	3	
	5	●	MPS1-0360L-DIN-C	19.8	25.2	28.7	65.7	65	0.7	6	1	
	2	●	MPS1-0360-PC	7.8	20.6	23.1	55.6	55	0.6	6	1	
	8	●	MPS1-0360-L8C	29.5	44.7	50.7	87.7	87	0.7	6	1	
	10	□	MPS1-0360-L10C	36.7	50.7	55.7	92.7	92	0.7	6	1	
	12	●	MPS1-0360-L12C	43.9	58.7	63.7	100.7	100	0.7	6	1	
	15	●	MPS1-0360-L15C	54.7	70.7	75.7	112.7	112	0.7	6	1	
	20	●	MPS1-0360-L20C	72.7	90.7	95.7	132.7	132	0.7	6	1	
	25	□	MPS1-0360-L25C	90.7	110.7	115.7	152.7	152	0.7	6	1	
	30	●	MPS1-0360-L30C	108.7	130.7	135.7	172.7	172	0.7	6	1	
	35	□	MPS1-0360-L35C	126.7	143.7	155.7	192.7	192	0.7	6	1	
	40	●	MPS1-0360-L40C	144.7	160.7	175.7	212.7	212	0.7	6	1	
3.7	3	□	MPS1-0370S-DIN	14.1	19.7	24.7	61.7	61	0.7	6	3	
	3	●	MPS1-0370S-DIN-C	14.1	19.7	24.7	61.7	61	0.7	6	1	
	5	□	MPS1-0370L-DIN	20.1	25.7	28.7	65.7	65	0.7	6	3	
	5	●	MPS1-0370L-DIN-C	20.1	25.7	28.7	65.7	65	0.7	6	1	
	2	●	MPS1-0370-PC	8.0	20.6	23.1	55.6	55	0.6	6	1	
	8	●	MPS1-0370-L8C	30.4	44.8	50.8	87.8	87	0.8	6	1	
	10	□	MPS1-0370-L10C	37.7	50.7	55.7	92.7	92	0.7	6	1	
	12	●	MPS1-0370-L12C	45.1	58.7	63.7	100.7	100	0.7	6	1	
	15	●	MPS1-0370-L15C	56.2	70.7	75.7	112.7	112	0.7	6	1	
	20	●	MPS1-0370-L20C	74.7	90.7	95.7	132.7	132	0.7	6	1	
	25	●	MPS1-0370-L25C	93.2	110.7	115.7	152.7	152	0.7	6	1	
	30	●	MPS1-0370-L30C	111.7	130.7	135.7	172.7	172	0.7	6	1	
	35	□	MPS1-0370-L35C	130.2	143.7	155.7	192.7	192	0.7	6	1	
	40	●	MPS1-0370-L40C	148.7	160.7	175.7	212.7	212	0.7	6	1	

DC (mm)	Głębokość otworu (L/D)	DP1021	Numer zamówieniowy	Wymiary (mm)								Typ
				LU	LCF	LH	OAL	LF	PL	DCON		
3.8	3	□	MPS1-0380S-DIN	18.0	23.7	28.7	65.7	65	0.7	6	3	
	3	●	MPS1-0380S-DIN-C	18.0	23.7	28.7	65.7	65	0.7	6	1	
	5	□	MPS1-0380L-DIN	28.0	33.7	36.7	73.7	73	0.7	6	3	
	5	●	MPS1-0380L-DIN-C	28.0	33.7	36.7	73.7	73	0.7	6	1	
	2	●	MPS1-0380-PC	8.2	20.6	23.0	55.6	55	0.6	6	1	
	8	●	MPS1-0380-L8C	31.2	44.8	50.8	87.8	87	0.8	6	1	
	10	□	MPS1-0380-L10C	38.7	50.7	55.7	92.7	92	0.7	6	1	
	12	●	MPS1-0380-L12C	46.3	58.7	63.7	100.7	100	0.7	6	1	
	15	●	MPS1-0380-L15C	57.7	70.7	75.7	112.7	112	0.7	6	1	
	20	●	MPS1-0380-L20C	76.7	90.7	95.7	132.7	132	0.7	6	1	
	25	●	MPS1-0380-L25C	95.7	110.7	115.7	152.7	152	0.7	6	1	
	30	●	MPS1-0380-L30C	114.7	130.7	135.7	172.7	172	0.7	6	1	
	35	□	MPS1-0380-L35C	133.7	150.7	155.7	192.7	192	0.7	6	1	
	40	●	MPS1-0380-L40C	152.7	170.7	175.7	212.7	212	0.7	6	1	
3.9	3	□	MPS1-0390S-DIN	17.9	23.7	28.7	65.7	65	0.7	6	3	
	3	●	MPS1-0390S-DIN-C	17.9	23.7	28.7	65.7	65	0.7	6	1	
	5	□	MPS1-0390L-DIN	27.9	33.7	36.7	73.7	73	0.7	6	3	
	5	●	MPS1-0390L-DIN-C	27.9	33.7	36.7	73.7	73	0.7	6	1	
	2	●	MPS1-0390-PC	8.4	20.6	22.9	55.6	55	0.6	6	1	
	8	●	MPS1-0390-L8C	32.0	44.8	50.8	87.8	87	0.8	6	1	
	10	□	MPS1-0390-L10C	39.7	50.7	55.7	92.7	92	0.7	6	1	
	12	●	MPS1-0390-L12C	47.5	58.7	63.7	100.7	100	0.7	6	1	
	15	●	MPS1-0390-L15C	59.2	70.7	75.7	112.7	112	0.7	6	1	
	20	●	MPS1-0390-L20C	78.7	90.7	95.7	132.7	132	0.7	6	1	
	25	□	MPS1-0390-L25C	98.2	110.7	115.7	152.7	152	0.7	6	1	
	30	●	MPS1-0390-L30C	117.7	130.7	135.7	172.7	172	0.7	6	1	
	35	□	MPS1-0390-L35C	137.2	150.7	155.7	192.7	192	0.7	6	1	
	40	●	MPS1-0390-L40C	156.7	170.7	175.7	212.7	212	0.7	6	1	
4.0	3	□	MPS1-0400S-DIN	17.7	23.7	28.7	65.7	65	0.7	6	3	
	3	●	MPS1-0400S-DIN-C	17.7	23.7	28.7	65.7	65	0.7	6	1	
	5	□	MPS1-0400L-DIN	27.7	33.7	36.7	73.7	73	0.7	6	3	
	5	●	MPS1-0400L-DIN-C	27.7	33.7	36.7	73.7	73	0.7	6	1	
	2	●	MPS1-0400-PC	8.6	20.6	22.8	55.6	55	0.6	6	1	
	8	●	MPS1-0400-L8C	32.8	44.8	50.8	87.8	87	0.8	6	1	
	10	□	MPS1-0400-L10C	40.7	50.7	55.7	92.7	92	0.7	6	1	
	12	●	MPS1-0400-L12C	48.7	58.7	63.7	100.7	100	0.7	6	1	
	15	●	MPS1-0400-L15C	60.7	70.7	75.7	112.7	112	0.7	6	1	
	20	●	MPS1-0400-L20C	80.7	90.7	95.7	132.7	132	0.7	6	1	
	25	●	MPS1-0400-L25C	100.7	110.7	115.7	152.7	152	0.7	6	1	
	30	●	MPS1-0400-L30C	120.7	130.7	135.7	172.7	172	0.7	6	1	
	35	□	MPS1-0400-L35C	140.7	150.7	155.7	192.7	192	0.7	6	1	
	40	●	MPS1-0400-L40C	160.7	170.7	175.7	212.7	212	0.7	6	1	
4.05	3	□	MPS1-0405S-DIN	17.7	23.7	28.7	65.7	65	0.7	6	3	
	3	●	MPS1-0405S-DIN-C	17.7	23.7	28.7	65.7	65	0.7	6	1	
	5	□	MPS1-0405L-DIN	27.7	33.7	36.7	73.7	73	0.7	6	3	
	5	●	MPS1-0405L-DIN-C	27.7	33.7	36.7	73.7	73	0.7	6	1	

WIERCENIE (WIERTŁA PEŁNOWĘGLIKOWE)

MPS1

Wiertła z podwójną łysinką
i wiertła super długie

WĘGLIKI
SPIEKANE

M

WIERCENIE

DC (mm)	Głębokość otworu (L/D)	DP1021	Numer zamówieniowy	Wymiary (mm)							Typ
				LU	LCF	LH	OAL	LF	PL	DCON	
4.1	3	□	MPS1-0410S-DIN	17.6	23.7	28.7	65.7	65	0.7	6	3
	3	●	MPS1-0410S-DIN-C	17.6	23.7	28.7	65.7	65	0.7	6	1
	5	□	MPS1-0410L-DIN	27.6	33.7	36.7	73.7	73	0.7	6	3
	5	●	MPS1-0410L-DIN-C	27.6	33.7	36.7	73.7	73	0.7	6	1
	2	●	MPS1-0410-PC	8.8	22.6	24.7	62.6	62	0.6	6	1
	8	●	MPS1-0410-L8C	33.6	50.8	55.8	92.8	92	0.8	6	1
	10	□	MPS1-0410-L10C	41.7	58.7	62.7	99.7	99	0.7	6	1
	12	●	MPS1-0410-L12C	49.9	67.7	71.7	108.7	108	0.7	6	1
	15	●	MPS1-0410-L15C	62.2	80.7	84.7	121.7	121	0.7	6	1
	20	●	MPS1-0410-L20C	82.7	103.7	107.7	144.7	144	0.7	6	1
	25	●	MPS1-0410-L25C	103.2	125.7	129.7	166.7	166	0.7	6	1
	30	●	MPS1-0410-L30C	123.7	148.7	152.7	189.7	189	0.7	6	1
35	□	MPS1-0410-L35C	144.2	164.7	174.7	211.7	211	0.7	6	1	
40	●	MPS1-0410-L40C	164.7	184.7	198.7	235.7	235	0.7	6	1	
4.2	3	□	MPS1-0420S-DIN	17.5	23.8	28.8	65.8	65	0.8	6	3
	3	●	MPS1-0420S-DIN-C	17.5	23.8	28.8	65.8	65	0.8	6	1
	5	□	MPS1-0420L-DIN	28.0	34.3	36.8	73.8	73	0.8	6	3
	5	●	MPS1-0420L-DIN-C	28.0	34.3	36.8	73.8	73	0.8	6	1
	2	●	MPS1-0420-PC	9.1	22.7	24.6	62.7	62	0.7	6	1
	8	●	MPS1-0420-L8C	34.5	50.9	55.9	92.9	92	0.9	6	1
	10	□	MPS1-0420-L10C	42.8	58.8	62.8	99.8	99	0.8	6	1
	12	●	MPS1-0420-L12C	51.2	67.8	71.8	108.8	108	0.8	6	1
	15	●	MPS1-0420-L15C	63.8	80.8	84.8	121.8	121	0.8	6	1
	20	●	MPS1-0420-L20C	84.8	103.8	107.8	144.8	144	0.8	6	1
	25	●	MPS1-0420-L25C	105.8	125.8	129.8	166.8	166	0.8	6	1
	30	●	MPS1-0420-L30C	126.8	148.8	152.8	189.8	189	0.8	6	1
35	●	MPS1-0420-L35C	147.8	164.8	174.8	211.8	211	0.8	6	1	
40	●	MPS1-0420-L40C	168.8	184.8	198.8	235.8	235	0.8	6	1	
4.3	3	□	MPS1-0430S-DIN	17.3	23.8	28.8	65.8	65	0.8	6	3
	3	●	MPS1-0430S-DIN-C	17.3	23.8	28.8	65.8	65	0.8	6	1
	5	□	MPS1-0430L-DIN	27.8	34.3	36.8	73.8	73	0.8	6	3
	5	●	MPS1-0430L-DIN-C	27.8	34.3	36.8	73.8	73	0.8	6	1
	2	●	MPS1-0430-PC	9.3	22.7	24.5	62.7	62	0.7	6	1
	8	●	MPS1-0430-L8C	35.3	50.9	55.9	92.9	92	0.9	6	1
	10	□	MPS1-0430-L10C	43.8	58.8	62.8	99.8	99	0.8	6	1
	12	●	MPS1-0430-L12C	52.4	67.8	71.8	108.8	108	0.8	6	1
	15	●	MPS1-0430-L15C	65.3	80.8	84.8	121.8	121	0.8	6	1
	20	●	MPS1-0430-L20C	86.8	103.8	107.8	144.8	144	0.8	6	1
	25	●	MPS1-0430-L25C	108.3	125.8	129.8	166.8	166	0.8	6	1
	30	●	MPS1-0430-L30C	129.8	148.8	152.8	189.8	189	0.8	6	1
35	□	MPS1-0430-L35C	151.3	170.8	174.8	211.8	211	0.8	6	1	
40	●	MPS1-0430-L40C	172.8	194.8	198.8	235.8	235	0.8	6	1	
4.4	3	□	MPS1-0440S-DIN	17.2	23.8	28.8	65.8	65	0.8	6	3
	3	●	MPS1-0440S-DIN-C	17.2	23.8	28.8	65.8	65	0.8	6	1
	5	□	MPS1-0440L-DIN	27.7	34.3	36.8	73.8	73	0.8	6	3
	5	●	MPS1-0440L-DIN-C	27.7	34.3	36.8	73.8	73	0.8	6	1
	2	●	MPS1-0440-PC	9.5	22.7	24.4	62.7	62	0.7	6	1
	8	●	MPS1-0440-L8C	36.1	50.9	55.9	92.9	92	0.9	6	1
	10	□	MPS1-0440-L10C	44.8	58.8	62.8	99.8	99	0.8	6	1
	12	●	MPS1-0440-L12C	53.6	67.8	71.8	108.8	108	0.8	6	1
	15	●	MPS1-0440-L15C	66.8	80.8	84.8	121.8	121	0.8	6	1
	20	□	MPS1-0440-L20C	88.8	103.8	107.8	144.8	144	0.8	6	1
	25	□	MPS1-0440-L25C	110.8	125.8	129.8	166.8	166	0.8	6	1
	30	□	MPS1-0440-L30C	132.8	148.8	152.8	189.8	189	0.8	6	1
35	□	MPS1-0440-L35C	154.8	170.8	174.8	211.8	211	0.8	6	1	
40	●	MPS1-0440-L40C	176.8	194.8	198.8	235.8	235	0.8	6	1	

DC (mm)	Głębokość otworu (L/D)	DP1021	Numer zamówieniowy	Wymiary (mm)							Typ
				LU	LCF	LH	OAL	LF	PL	DCON	
4.5	3	□	MPS1-0450S-DIN	17.1	23.8	28.8	65.8	65	0.8	6	3
	3	●	MPS1-0450S-DIN-C	17.1	23.8	28.8	65.8	65	0.8	6	1
	5	□	MPS1-0450L-DIN	27.6	34.3	36.8	73.8	73	0.8	6	3
	5	●	MPS1-0450L-DIN-C	27.6	34.3	36.8	73.8	73	0.8	6	1
	2	●	MPS1-0450-PC	9.7	22.7	24.3	62.7	62	0.7	6	1
	8	●	MPS1-0450-L8C	36.9	50.9	55.9	92.9	92	0.9	6	1
	10	□	MPS1-0450-L10C	45.8	58.8	62.8	99.8	99	0.8	6	1
	12	●	MPS1-0450-L12C	54.8	67.8	71.8	108.8	108	0.8	6	1
	15	●	MPS1-0450-L15C	68.3	80.8	84.8	121.8	121	0.8	6	1
	20	●	MPS1-0450-L20C	90.8	103.8	107.8	144.8	144	0.8	6	1
	25	●	MPS1-0450-L25C	113.3	125.8	129.8	166.8	166	0.8	6	1
	30	●	MPS1-0450-L30C	135.8	148.8	152.8	189.8	189	0.8	6	1
35	□	MPS1-0450-L35C	158.3	170.8	174.8	211.8	211	0.8	6	1	
40	●	MPS1-0450-L40C	180.8	194.8	198.8	235.8	235	0.8	6	1	
4.6	3	□	MPS1-0460S-DIN	16.9	23.8	28.8	65.8	65	0.8	6	4
	3	●	MPS1-0460S-DIN-C	16.9	23.8	28.8	65.8	65	0.8	6	2
	5	□	MPS1-0460L-DIN	28.9	35.8	36.8	73.8	73	0.8	6	4
	5	●	MPS1-0460L-DIN-C	28.9	35.8	36.8	73.8	73	0.8	6	2
	2	●	MPS1-0460-PC	9.9	24.7	27.7	62.7	62	0.7	6	2
	8	●	MPS1-0460-L8C	37.8	56.0	59.0	96.0	95	1.0	6	2
	10	□	MPS1-0460-L10C	46.8	65.8	68.8	105.8	105	0.8	6	2
	12	●	MPS1-0460-L12C	56.0	75.8	78.8	115.8	115	0.8	6	2
	15	●	MPS1-0460-L15C	69.8	90.8	93.8	130.8	130	0.8	6	2
	20	●	MPS1-0460-L20C	92.8	115.8	118.8	155.8	155	0.8	6	2
	25	●	MPS1-0460-L25C	115.8	140.8	143.8	180.8	180	0.8	6	2
	30	●	MPS1-0460-L30C	138.8	165.8	168.8	205.8	205	0.8	6	2
35	□	MPS1-0460-L35C	161.8	184.8	192.8	229.8	229	0.8	6	2	
40	●	MPS1-0460-L40C	184.8	204.8	217.8	254.8	254	0.8	6	2	
4.65	3	□	MPS1-0465S-DIN	16.9	23.8	28.8	65.8	65	0.8	6	4
	3	●	MPS1-0465S-DIN-C	16.9	23.8	28.8	65.8	65	0.8	6	2
	5	□	MPS1-0465L-DIN	28.9	35.8	36.8	73.8	73	0.8	6	4
	5	●	MPS1-0465L-DIN-C	28.9	35.8	36.8	73.8	73	0.8	6	2
4.7	3	□	MPS1-0470S-DIN	16.8	23.9	28.9	65.9	65	0.9	6	4
	3	●	MPS1-0470S-DIN-C	16.8	23.9	28.9	65.9	65	0.9	6	2
	5	□	MPS1-0470L-DIN	28.8	35.9	36.9	73.9	73	0.9	6	4
	5	●	MPS1-0470L-DIN-C	28.8	35.9	36.9	73.9	73	0.9	6	2
	2	●	MPS1-0470-PC	10.1	24.7	27.7	62.7	62	0.7	6	2
	8	●	MPS1-0470-L8C	38.6	56.0	59.0	96.0	95	1.0	6	2
	10	□	MPS1-0470-L10C	47.9	65.9	68.9	105.9	105	0.9	6	2
	12	●	MPS1-0470-L12C	57.3	75.9	78.9	115.9	115	0.9	6	2
	15	●	MPS1-0470-L15C	71.4	90.9	93.9	130.9	130	0.9	6	2
	20	●	MPS1-0470-L20C	94.9	115.9	118.9	155.9	155	0.9	6	2
	25	●	MPS1-0470-L25C	118.4	140.9	143.9	180.9	180	0.9	6	2
	30	●	MPS1-0470-L30C	141.9	165.9	168.9	205.9	205	0.9	6	2
35	□	MPS1-0470-L35C	165.4	184.9	192.9	229.9	229	0.9	6	2	
40	●	MPS1-0470-L40C	188.9	204.9	217.9	254.9	254	0.9	6	2	

● : Standard magazynowy. □ : Niestandardowy, produkowany na specjalne zamówienie.

DC (mm)	Głębokość otworu (L/D)	DP1021	Numer zamówieniowy	Wymiary (mm)								Typ
				LU	LCF	LH	OAL	LF	PL	DCON		
4.8	3	□	MPS1-0480S-DIN	20.7	27.9	28.9	65.9	65	0.9	6	4	
	3	●	MPS1-0480S-DIN-C	20.7	27.9	28.9	65.9	65	0.9	6	2	
	5	□	MPS1-0480L-DIN	36.7	43.9	44.9	81.9	81	0.9	6	4	
	5	●	MPS1-0480L-DIN-C	36.7	43.9	44.9	81.9	81	0.9	6	2	
	2	●	MPS1-0480-PC	10.4	24.8	27.8	62.8	62	0.8	6	2	
	8	●	MPS1-0480-L8C	39.4	56.0	59.0	96.0	95	1.0	6	2	
	10	□	MPS1-0480-L10C	48.9	65.9	68.9	105.9	105	0.9	6	2	
	12	●	MPS1-0480-L12C	58.5	75.9	78.9	115.9	115	0.9	6	2	
	15	●	MPS1-0480-L15C	72.9	90.9	93.9	130.9	130	0.9	6	2	
	20	●	MPS1-0480-L20C	96.9	115.9	118.9	155.9	155	0.9	6	2	
	25	●	MPS1-0480-L25C	120.9	140.9	143.9	180.9	180	0.9	6	2	
	30	●	MPS1-0480-L30C	144.9	165.9	168.9	205.9	205	0.9	6	2	
	35	□	MPS1-0480-L35C	168.9	190.9	192.9	229.9	229	0.9	6	2	
	40	●	MPS1-0480-L40C	192.9	215.9	217.9	254.9	254	0.9	6	2	
	4.9	3	□	MPS1-0490S-DIN	20.5	27.9	28.9	65.9	65	0.9	6	4
		3	●	MPS1-0490S-DIN-C	20.5	27.9	28.9	65.9	65	0.9	6	2
5		□	MPS1-0490L-DIN	36.5	43.9	44.9	81.9	81	0.9	6	4	
5		●	MPS1-0490L-DIN-C	36.5	43.9	44.9	81.9	81	0.9	6	2	
2		●	MPS1-0490-PC	10.6	24.8	27.8	62.8	62	0.8	6	2	
8		●	MPS1-0490-L8C	40.2	56.0	59.0	96.0	95	1.0	6	2	
10		□	MPS1-0490-L10C	49.9	65.9	68.9	105.9	105	0.9	6	2	
12		●	MPS1-0490-L12C	59.7	75.9	78.9	115.9	115	0.9	6	2	
15		●	MPS1-0490-L15C	74.4	90.9	93.9	130.9	130	0.9	6	2	
20		□	MPS1-0490-L20C	98.9	115.9	118.9	155.9	155	0.9	6	2	
25		●	MPS1-0490-L25C	123.4	140.9	143.9	180.9	180	0.9	6	2	
30		●	MPS1-0490-L30C	147.9	165.9	168.9	205.9	205	0.9	6	2	
35		□	MPS1-0490-L35C	172.4	190.9	192.9	229.9	229	0.9	6	2	
40		●	MPS1-0490-L40C	196.9	215.9	217.9	254.9	254	0.9	6	2	
5.0		3	□	MPS1-0500S-DIN	20.4	27.9	28.9	65.9	65	0.9	6	4
		3	●	MPS1-0500S-DIN-C	20.4	27.9	28.9	65.9	65	0.9	6	2
	5	□	MPS1-0500L-DIN	36.4	43.9	44.9	81.9	81	0.9	6	4	
	5	●	MPS1-0500L-DIN-C	36.4	43.9	44.9	81.9	81	0.9	6	2	
	2	●	MPS1-0500-PC	10.8	24.8	25.8	62.8	62	0.8	6	2	
	8	●	MPS1-0500-L8C	41.0	56.0	59.0	96.0	95	1.0	6	2	
	10	□	MPS1-0500-L10C	50.9	65.9	68.9	105.9	105	0.9	6	2	
	12	●	MPS1-0500-L12C	60.9	75.9	78.9	115.9	115	0.9	6	2	
	15	●	MPS1-0500-L15C	75.9	90.9	93.9	130.9	130	0.9	6	2	
	20	●	MPS1-0500-L20C	100.9	115.9	118.9	155.9	155	0.9	6	2	
	25	●	MPS1-0500-L25C	125.9	140.9	143.9	180.9	180	0.9	6	2	
	30	●	MPS1-0500-L30C	150.9	165.9	168.9	205.9	205	0.9	6	2	
	35	□	MPS1-0500-L35C	175.9	190.9	192.9	229.9	229	0.9	6	2	
	40	●	MPS1-0500-L40C	200.9	215.9	217.9	254.9	254	0.9	6	2	
	5.05	3	□	MPS1-0505S-DIN	20.3	27.9	28.9	65.9	65	0.9	6	4
		3	●	MPS1-0505S-DIN-C	20.3	27.9	28.9	65.9	65	0.9	6	2
5		□	MPS1-0505L-DIN	36.3	43.9	44.9	81.9	81	0.9	6	4	
5		●	MPS1-0505L-DIN-C	36.3	43.9	44.9	81.9	81	0.9	6	2	

DC (mm)	Głębokość otworu (L/D)	DP1021	Numer zamówieniowy	Wymiary (mm)								Typ
				LU	LCF	LH	OAL	LF	PL	DCON		
5.1	3	□	MPS1-0510S-DIN	20.3	27.9	28.9	65.9	65	0.9	6	4	
	3	●	MPS1-0510S-DIN-C	20.3	27.9	28.9	65.9	65	0.9	6	2	
	5	□	MPS1-0510L-DIN	36.3	43.9	44.9	81.9	81	0.9	6	4	
	5	●	MPS1-0510L-DIN-C	36.3	43.9	44.9	81.9	81	0.9	6	2	
	2	●	MPS1-0510-PC	11.0	26.8	28.8	66.8	66	0.8	6	2	
	8	●	MPS1-0510-L8C	41.9	62.1	65.1	102.1	101	1.1	6	2	
	10	□	MPS1-0510-L10C	51.9	72.9	75.9	112.9	112	0.9	6	2	
	12	●	MPS1-0510-L12C	62.1	83.9	86.9	123.9	123	0.9	6	2	
	15	●	MPS1-0510-L15C	77.4	99.9	102.9	139.9	139	0.9	6	2	
	20	●	MPS1-0510-L20C	102.9	127.9	130.9	167.9	167	0.9	6	2	
	25	●	MPS1-0510-L25C	128.4	154.9	157.9	194.9	194	0.9	6	2	
	30	●	MPS1-0510-L30C	153.9	182.9	185.9	222.9	222	0.9	6	2	
	35	□	MPS1-0510-L35C	179.4	203.9	211.9	248.9	248	0.9	6	2	
	40	●	MPS1-0510-L40C	204.9	230.9	241.9	278.9	278	0.9	6	2	
	5.2	3	□	MPS1-0520S-DIN	20.1	27.9	28.9	65.9	65	0.9	6	4
		3	●	MPS1-0520S-DIN-C	20.1	27.9	28.9	65.9	65	0.9	6	2
5		□	MPS1-0520L-DIN	36.1	43.9	44.9	81.9	81	0.9	6	4	
5		●	MPS1-0520L-DIN-C	36.1	43.9	44.9	81.9	81	0.9	6	2	
2		●	MPS1-0520-PC	11.2	26.8	28.8	66.8	66	0.8	6	2	
8		●	MPS1-0520-L8C	42.7	62.1	65.1	102.1	101	1.1	6	2	
10		□	MPS1-0520-L10C	52.9	72.9	75.9	112.9	112	0.9	6	2	
12		●	MPS1-0520-L12C	63.3	83.9	86.9	123.9	123	0.9	6	2	
15		●	MPS1-0520-L15C	78.9	99.9	102.9	139.9	139	0.9	6	2	
20		●	MPS1-0520-L20C	104.9	127.9	130.9	167.9	167	0.9	6	2	
25		●	MPS1-0520-L25C	130.9	154.9	157.9	194.9	194	0.9	6	2	
30		●	MPS1-0520-L30C	156.9	182.9	185.9	222.9	222	0.9	6	2	
35		□	MPS1-0520-L35C	182.9	203.9	211.9	248.9	248	0.9	6	2	
40		●	MPS1-0520-L40C	208.9	230.9	241.9	278.9	278	0.9	6	2	
5.3		3	□	MPS1-0530S-DIN	20.0	28.0	29.0	66.0	65	1.0	6	4
		3	●	MPS1-0530S-DIN-C	20.0	28.0	29.0	66.0	65	1.0	6	2
	5	□	MPS1-0530L-DIN	36.0	44.0	45.0	82.0	81	1.0	6	4	
	5	●	MPS1-0530L-DIN-C	36.0	44.0	45.0	82.0	81	1.0	6	2	
	2	●	MPS1-0530-PC	11.4	26.8	28.8	66.8	66	0.8	6	2	
	8	●	MPS1-0530-L8C	43.5	62.1	65.1	102.1	101	1.1	6	2	
	10	□	MPS1-0530-L10C	54.0	73.0	76.0	113.0	112	1.0	6	2	
	12	●	MPS1-0530-L12C	64.6	84.0	87.0	124.0	123	1.0	6	2	
	15	●	MPS1-0530-L15C	80.5	100.0	103.0	140.0	139	1.0	6	2	
	20	□	MPS1-0530-L20C	107.0	128.0	131.0	168.0	167	1.0	6	2	
	25	●	MPS1-0530-L25C	133.5	155.0	158.0	195.0	194	1.0	6	2	
	30	●	MPS1-0530-L30C	160.0	183.0	186.0	223.0	222	1.0	6	2	
	35	□	MPS1-0530-L35C	186.5	210.0	212.0	249.0	248	1.0	6	2	
	40	●	MPS1-0530-L40C	213.0	241.0	242.0	279.0	278	1.0	6	2	
	5.4	3	□	MPS1-0540S-DIN	19.9	28.0	29.0	66.0	65	1.0	6	2
		3	●	MPS1-0540S-DIN-C	19.9	28.0	29.0	66.0	65	1.0	6	2
5		□	MPS1-0540L-DIN	35.9	44.0	45.0	82.0	81	1.0	6	4	
5		●	MPS1-0540L-DIN-C	35.9	44.0	45.0	82.0	81	1.0	6	2	
2		●	MPS1-0540-PC	11.7	26.9	28.9	66.9	66	0.9	6	2	
8		●	MPS1-0540-L8C	44.3	62.1	65.1	102.1	101	1.1	6	2	
10		□	MPS1-0540-L10C	55.0	73.0	76.0	113.0	112	1.0	6	2	
12		●	MPS1-0540-L12C	65.8	84.0	87.0	124.0	123	1.0	6	2	
15		●	MPS1-0540-L15C	82.0	100.0	103.0	140.0	139	1.0	6	2	
20		●	MPS1-0540-L20C	109.0	128.0	131.0	168.0	167	1.0	6	2	
25		□	MPS1-0540-L25C	136.0	155.0	158.0	195.0	194	1.0	6	2	
30		□	MPS1-0540-L30C	163.0	183.0	186.0	223.0	222	1.0	6	2	
35		□	MPS1-0540-L35C	190.0	210.0	212.0	249.0	248	1.0	6	2	
40		●	MPS1-0540-L40C	217.0	241.0	242.0	279.0	278	1.0	6	2	

WIERCENIE (WIERTŁA PEŁNOWĘGLIKOWE)

MPS1

Wiertła z podwójną łysinką
i wiertła super długie

WĘGLIKI
SPIEKANE

M

WIERCENIE

DC (mm)	Głębokość otworu (L/D)	DP1021	Numer zamówieniowy	Wymiary (mm)							Typ
				LU	LCF	LH	OAL	LF	PL	DCON	
5.5	3	□	MPS1-0550S-DIN	19.8	28.0	29.0	66.0	65	1.0	6	4
	3	●	MPS1-0550S-DIN-C	19.8	28.0	29.0	66.0	65	1.0	6	2
	5	□	MPS1-0550L-DIN	35.8	44.0	45.0	82.0	81	1.0	6	4
	5	●	MPS1-0550L-DIN-C	35.8	44.0	45.0	82.0	81	1.0	6	2
	2	●	MPS1-0550-PC	11.9	26.9	28.9	66.9	66	0.9	6	2
	8	●	MPS1-0550-L8C	45.1	62.1	65.1	102.1	101	1.1	6	2
	10	□	MPS1-0550-L10C	56.0	73.0	76.0	113.0	112	1.0	6	2
	12	●	MPS1-0550-L12C	67.0	84.0	87.0	124.0	123	1.0	6	2
	15	●	MPS1-0550-L15C	83.5	100.0	103.0	140.0	139	1.0	6	2
	20	●	MPS1-0550-L20C	111.0	128.0	131.0	168.0	167	1.0	6	2
	25	●	MPS1-0550-L25C	138.5	155.0	158.0	195.0	194	1.0	6	2
	30	●	MPS1-0550-L30C	166.0	183.0	186.0	223.0	222	1.0	6	2
35	□	MPS1-0550-L35C	193.5	210.0	212.0	249.0	248	1.0	6	2	
40	●	MPS1-0550-L40C	221.0	241.0	242.0	279.0	278	1.0	6	2	
5.55	3	□	MPS1-0555S-DIN	19.7	28.0	29.0	66.0	65	1.0	6	4
	3	●	MPS1-0555S-DIN-C	19.7	28.0	29.0	66.0	65	1.0	6	2
	5	□	MPS1-0555L-DIN	35.7	44.0	45.0	82.0	81	1.0	6	4
	5	●	MPS1-0555L-DIN-C	35.7	44.0	45.0	82.0	81	1.0	6	2
5.6	3	□	MPS1-0560S-DIN	19.6	28.0	29.0	66.0	65	1.0	6	4
	3	●	MPS1-0560S-DIN-C	19.6	28.0	29.0	66.0	65	1.0	6	2
	5	□	MPS1-0560L-DIN	35.6	44.0	45.0	82.0	81	1.0	6	4
	5	●	MPS1-0560L-DIN-C	35.6	44.0	45.0	82.0	81	1.0	6	2
	2	●	MPS1-0560-PC	12.1	28.9	28.9	66.9	66	0.9	6	2
	8	●	MPS1-0560-L8C	46.0	67.2	70.2	107.2	106	1.2	6	2
	10	□	MPS1-0560-L10C	57.0	79.0	82.0	119.0	118	1.0	6	2
	12	●	MPS1-0560-L12C	68.2	91.0	94.0	131.0	130	1.0	6	2
	15	●	MPS1-0560-L15C	85.0	109.0	112.0	149.0	148	1.0	6	2
	20	□	MPS1-0560-L20C	113.0	139.0	142.0	179.0	178	1.0	6	2
	25	□	MPS1-0560-L25C	141.0	169.0	172.0	209.0	208	1.0	6	2
	30	●	MPS1-0560-L30C	169.0	199.0	202.0	239.0	238	1.0	6	2
35	□	MPS1-0560-L35C	197.0	223.0	231.0	268.0	267	1.0	6	2	
40	●	MPS1-0560-L40C	225.0	251.0	262.0	299.0	298	1.0	6	2	
5.7	3	□	MPS1-0570S-DIN	19.5	28.0	29.0	66.0	65	1.0	6	4
	3	●	MPS1-0570S-DIN-C	19.5	28.0	29.0	66.0	65	1.0	6	2
	5	□	MPS1-0570L-DIN	35.5	44.0	45.0	82.0	81	1.0	6	4
	5	●	MPS1-0570L-DIN-C	35.5	44.0	45.0	82.0	81	1.0	6	2
	2	●	MPS1-0570-PC	12.3	28.9	28.9	66.9	66	0.9	6	2
	8	●	MPS1-0570-L8C	46.8	67.2	70.2	107.2	106	1.2	6	2
	10	□	MPS1-0570-L10C	58.0	79.0	82.0	119.0	118	1.0	6	2
	12	●	MPS1-0570-L12C	69.4	91.0	94.0	131.0	130	1.0	6	2
	15	●	MPS1-0570-L15C	86.5	109.0	112.0	149.0	148	1.0	6	2
	20	□	MPS1-0570-L20C	115.0	139.0	142.0	179.0	178	1.0	6	2
	25	●	MPS1-0570-L25C	143.5	169.0	172.0	209.0	208	1.0	6	2
	30	□	MPS1-0570-L30C	172.0	199.0	202.0	239.0	238	1.0	6	2
35	□	MPS1-0570-L35C	200.5	223.0	231.0	268.0	267	1.0	6	2	
40	●	MPS1-0570-L40C	229.0	251.0	262.0	299.0	298	1.0	6	2	

DC (mm)	Głębokość otworu (L/D)	DP1021	Numer zamówieniowy	Wymiary (mm)							Typ
				LU	LCF	LH	OAL	LF	PL	DCON	
5.8	3	□	MPS1-0580S-DIN	19.4	28.1	29.1	66.1	65	1.1	6	4
	3	●	MPS1-0580S-DIN-C	19.4	28.1	29.1	66.1	65	1.1	6	2
	5	□	MPS1-0580L-DIN	35.4	44.1	45.1	82.1	81	1.1	6	4
	5	●	MPS1-0580L-DIN-C	35.4	44.1	45.1	82.1	81	1.1	6	2
	2	●	MPS1-0580-PC	12.5	28.9	28.9	66.9	66	0.9	6	2
	8	●	MPS1-0580-L8C	47.6	67.2	70.2	107.2	106	1.2	6	2
	10	□	MPS1-0580-L10C	59.1	79.1	82.1	119.1	118	1.1	6	2
	12	●	MPS1-0580-L12C	70.7	91.1	94.1	131.1	130	1.1	6	2
	15	●	MPS1-0580-L15C	88.1	109.1	112.1	149.1	148	1.1	6	2
	20	●	MPS1-0580-L20C	117.1	139.1	142.1	179.1	178	1.1	6	2
	25	□	MPS1-0580-L25C	146.1	169.1	172.1	209.1	208	1.1	6	2
	30	●	MPS1-0580-L30C	175.1	199.1	202.1	239.1	238	1.1	6	2
35	□	MPS1-0580-L35C	204.1	229.1	231.1	268.1	267	1.1	6	2	
40	●	MPS1-0580-L40C	233.1	261.1	262.1	299.1	298	1.1	6	2	
5.9	3	□	MPS1-0590S-DIN	19.2	28.1	29.1	66.1	65	1.1	6	4
	3	●	MPS1-0590S-DIN-C	19.2	28.1	29.1	66.1	65	1.1	6	2
	5	□	MPS1-0590L-DIN	35.2	44.1	45.1	82.1	81	1.1	6	4
	5	●	MPS1-0590L-DIN-C	35.2	44.1	45.1	82.1	81	1.1	6	2
	2	●	MPS1-0590-PC	12.7	28.9	28.9	66.9	66	0.9	6	2
	8	●	MPS1-0590-L8C	48.4	67.2	70.2	107.2	106	1.2	6	2
	10	□	MPS1-0590-L10C	60.1	79.1	82.1	119.1	118	1.1	6	2
	12	●	MPS1-0590-L12C	71.9	91.1	94.1	131.1	130	1.1	6	2
	15	●	MPS1-0590-L15C	89.6	109.1	112.1	149.1	148	1.1	6	2
	20	●	MPS1-0590-L20C	119.1	139.1	142.1	179.1	178	1.1	6	2
	25	●	MPS1-0590-L25C	148.6	169.1	172.1	209.1	208	1.1	6	2
	30	□	MPS1-0590-L30C	178.1	199.1	202.1	239.1	238	1.1	6	2
35	□	MPS1-0590-L35C	207.6	229.1	231.1	268.1	267	1.1	6	2	
40	●	MPS1-0590-L40C	237.1	261.1	262.1	299.1	298	1.1	6	2	
6.0	3	□	MPS1-0600S-DIN	19.1	28.1	29.1	66.1	65	1.1	6	4
	3	●	MPS1-0600S-DIN-C	19.1	28.1	29.1	66.1	65	1.1	6	2
	5	□	MPS1-0600L-DIN	35.1	44.1	45.1	82.1	81	1.1	6	4
	5	●	MPS1-0600L-DIN-C	35.1	44.1	45.1	82.1	81	1.1	6	2
	2	●	MPS1-0600-PC	12.9	28.9	28.9	66.9	66	0.9	6	2
	8	●	MPS1-0600-L8C	49.2	67.2	70.2	107.2	106	1.2	6	2
	10	□	MPS1-0600-L10C	61.1	79.1	82.1	119.1	118	1.1	6	2
	12	●	MPS1-0600-L12C	73.1	91.1	94.1	131.1	130	1.1	6	2
	15	●	MPS1-0600-L15C	91.1	109.1	112.1	149.1	148	1.1	6	2
	20	●	MPS1-0600-L20C	121.1	139.1	142.1	179.1	178	1.1	6	2
	25	●	MPS1-0600-L25C	151.1	169.1	172.1	209.1	208	1.1	6	2
	30	●	MPS1-0600-L30C	181.1	199.1	202.1	239.1	238	1.1	6	2
35	□	MPS1-0600-L35C	211.1	229.1	231.1	268.1	267	1.1	6	2	
40	●	MPS1-0600-L40C	241.1	261.1	262.1	299.1	298	1.1	6	2	
6.05	3	□	MPS1-0605S-DIN	25.0	34.1	42.1	79.1	78	1.1	8	4
	3	●	MPS1-0605S-DIN-C	25.0	34.1	42.1	79.1	78	1.1	8	2
	5	□	MPS1-0605L-DIN	44.0	53.1	54.1	91.1	90	1.1	8	4
	5	●	MPS1-0605L-DIN-C	44.0	53.1	54.1	91.1	90	1.1	8	2

● : Standard magazynowy. □ : Niestandardowy, produkowany na specjalne zamówienie.

DC (mm)	Głębokość otworu (L/D)	DP1021	Numer zamówieniowy	Wymiary (mm)							Typ	
				LU	LCF	LH	OAL	LF	PL	DCON		
6.1	3	□	MPS1-0610S-DIN	25.0	34.1	42.1	79.1	78	1.1	8	4	
	3	●	MPS1-0610S-DIN-C	25.0	34.1	42.1	79.1	78	1.1	8	2	
	5	□	MPS1-0610L-DIN	44.0	53.1	54.1	91.1	90	1.1	8	4	
	5	●	MPS1-0610L-DIN-C	44.0	53.1	54.1	91.1	90	1.1	8	2	
	2	●	MPS1-0610-PC	13.2	32.0	35.0	75.0	74	1.0	8	2	
	8	●	MPS1-0610-L8C	50.1	73.3	76.3	113.3	112	1.3	8	2	
	10	□	MPS1-0610-L10C	62.1	86.1	89.1	126.1	125	1.1	8	2	
	12	●	MPS1-0610-L12C	74.3	99.1	102.1	139.1	138	1.1	8	2	
	15	●	MPS1-0610-L15C	92.6	118.1	121.1	158.1	157	1.1	8	2	
	20	●	MPS1-0610-L20C	123.1	151.1	154.1	191.1	190	1.1	8	2	
	25	●	MPS1-0610-L25C	153.6	183.1	186.1	223.1	222	1.1	8	2	
	30	●	MPS1-0610-L30C	184.1	216.1	219.1	256.1	255	1.1	8	2	
	35	□	MPS1-0610-L35C	214.6	241.1	250.1	287.1	286	1.1	8	2	
	40	●	MPS1-0610-L40C	245.1	271.1	284.1	321.1	320	1.1	8	2	
	6.2	3	□	MPS1-0620S-DIN	24.8	34.1	42.1	79.1	78	1.1	8	4
		3	●	MPS1-0620S-DIN-C	24.8	34.1	42.1	79.1	78	1.1	8	2
5		□	MPS1-0620L-DIN	43.8	53.1	54.1	91.1	90	1.1	8	4	
5		●	MPS1-0620L-DIN-C	43.8	53.1	54.1	91.1	90	1.1	8	2	
2		●	MPS1-0620-PC	13.4	32.0	35.0	75.0	74	1.0	8	2	
8		●	MPS1-0620-L8C	50.9	73.3	76.3	113.3	112	1.3	8	2	
10		□	MPS1-0620-L10C	63.1	86.1	89.1	126.1	125	1.1	8	2	
12		●	MPS1-0620-L12C	75.5	99.1	102.1	139.1	138	1.1	8	2	
15		●	MPS1-0620-L15C	94.1	118.1	121.1	158.1	157	1.1	8	2	
20		●	MPS1-0620-L20C	125.1	151.1	154.1	191.1	190	1.1	8	2	
25		□	MPS1-0620-L25C	156.1	183.1	186.1	223.1	222	1.1	8	2	
30		●	MPS1-0620-L30C	187.1	216.1	219.1	256.1	255	1.1	8	2	
35		□	MPS1-0620-L35C	218.1	241.1	250.1	287.1	286	1.1	8	2	
40		●	MPS1-0620-L40C	249.1	271.1	284.1	321.1	320	1.1	8	2	
6.3		3	□	MPS1-0630S-DIN	24.7	34.1	42.1	79.1	78	1.1	8	4
		3	●	MPS1-0630S-DIN-C	24.7	34.1	42.1	79.1	78	1.1	8	2
	5	□	MPS1-0630L-DIN	43.7	53.1	54.1	91.1	90	1.1	8	4	
	5	●	MPS1-0630L-DIN-C	43.7	53.1	54.1	91.1	90	1.1	8	2	
	2	●	MPS1-0630-PC	13.6	32.0	35.0	75.0	74	1.0	8	2	
	8	●	MPS1-0630-L8C	51.7	73.3	76.3	113.3	112	1.3	8	2	
	10	□	MPS1-0630-L10C	64.1	86.1	89.1	126.1	125	1.1	8	2	
	12	●	MPS1-0630-L12C	76.7	99.1	102.1	139.1	138	1.1	8	2	
	15	●	MPS1-0630-L15C	95.6	118.1	121.1	158.1	157	1.1	8	2	
	20	●	MPS1-0630-L20C	127.1	151.1	154.1	191.1	190	1.1	8	2	
	25	□	MPS1-0630-L25C	158.6	183.1	186.1	223.1	222	1.1	8	2	
	30	●	MPS1-0630-L30C	190.1	216.1	219.1	256.1	255	1.1	8	2	
	35	□	MPS1-0630-L35C	221.6	248.1	250.1	287.1	286	1.1	8	2	
	40	●	MPS1-0630-L40C	253.1	281.1	284.1	321.1	320	1.1	8	2	
	6.4	3	□	MPS1-0640S-DIN	24.6	34.2	42.2	79.2	78	1.2	8	4
		3	●	MPS1-0640S-DIN-C	24.6	34.2	42.2	79.2	78	1.2	8	2
5		□	MPS1-0640L-DIN	43.6	53.2	54.2	91.2	90	1.2	8	4	
5		●	MPS1-0640L-DIN-C	43.6	53.2	54.2	91.2	90	1.2	8	2	
2		●	MPS1-0640-PC	13.8	32.0	35.0	75.0	74	1.0	8	2	
8		●	MPS1-0640-L8C	52.5	73.3	76.3	113.3	112	1.3	8	2	
10		□	MPS1-0640-L10C	65.2	86.2	89.2	126.2	125	1.2	8	2	
12		●	MPS1-0640-L12C	78.0	99.2	102.2	139.2	138	1.2	8	2	
15		●	MPS1-0640-L15C	97.2	118.2	121.2	158.2	157	1.2	8	2	
20		●	MPS1-0640-L20C	129.2	151.2	154.2	191.2	190	1.2	8	2	
25		●	MPS1-0640-L25C	161.2	183.2	186.2	223.2	222	1.2	8	2	
30		●	MPS1-0640-L30C	193.2	216.2	219.2	256.2	255	1.2	8	2	
35		□	MPS1-0640-L35C	225.2	248.2	250.2	287.2	286	1.2	8	2	
40		●	MPS1-0640-L40C	257.2	281.2	284.2	321.2	320	1.2	8	2	

DC (mm)	Głębokość otworu (L/D)	DP1021	Numer zamówieniowy	Wymiary (mm)							Typ	
				LU	LCF	LH	OAL	LF	PL	DCON		
6.5	3	□	MPS1-0650S-DIN	24.4	34.2	42.2	79.2	78	1.2	8	4	
	3	●	MPS1-0650S-DIN-C	24.4	34.2	42.2	79.2	78	1.2	8	2	
	5	□	MPS1-0650L-DIN	43.4	53.2	54.2	91.2	90	1.2	8	4	
	5	●	MPS1-0650L-DIN-C	43.4	53.2	54.2	91.2	90	1.2	8	2	
	2	●	MPS1-0650-PC	14.0	32.0	35.0	75.0	74	1.0	8	2	
	8	●	MPS1-0650-L8C	53.3	73.3	76.3	113.3	112	1.3	8	2	
	10	□	MPS1-0650-L10C	66.2	86.2	89.2	126.2	125	1.2	8	2	
	12	●	MPS1-0650-L12C	79.2	99.2	102.2	139.2	138	1.2	8	2	
	15	●	MPS1-0650-L15C	98.7	118.2	121.2	158.2	157	1.2	8	2	
	20	●	MPS1-0650-L20C	131.2	151.2	154.2	191.2	190	1.2	8	2	
	25	●	MPS1-0650-L25C	163.7	183.2	186.2	223.2	222	1.2	8	2	
	30	●	MPS1-0650-L30C	196.2	216.2	219.2	256.2	255	1.2	8	2	
	35	□	MPS1-0650-L35C	228.7	248.2	250.2	287.2	286	1.2	8	2	
	40	●	MPS1-0650-L40C	261.2	281.2	284.2	321.2	320	1.2	8	2	
	6.6	3	□	MPS1-0660S-DIN	24.3	34.2	42.2	79.2	78	1.2	8	4
		3	●	MPS1-0660S-DIN-C	24.3	34.2	42.2	79.2	78	1.2	8	2
5		□	MPS1-0660L-DIN	43.3	53.2	54.2	91.2	90	1.2	8	4	
5		●	MPS1-0660L-DIN-C	43.3	53.2	54.2	91.2	90	1.2	8	2	
2		●	MPS1-0660-PC	14.2	35.0	37.0	75.0	74	1.0	8	2	
8		●	MPS1-0660-L8C	54.2	78.4	81.4	118.4	117	1.4	8	2	
10		□	MPS1-0660-L10C	67.2	92.2	95.2	132.2	131	1.2	8	2	
12		●	MPS1-0660-L12C	80.4	106.2	109.2	146.2	145	1.2	8	2	
15		●	MPS1-0660-L15C	100.2	127.2	130.2	167.2	166	1.2	8	2	
20		□	MPS1-0660-L20C	133.2	162.2	165.2	202.2	201	1.2	8	2	
25		●	MPS1-0660-L25C	166.2	197.2	200.2	237.2	236	1.2	8	2	
30		●	MPS1-0660-L30C	199.2	232.2	235.2	272.2	271	1.2	8	2	
35		□	MPS1-0660-L35C	232.2	267.2	269.2	306.2	305	1.2	8	2	
40		●	MPS1-0660-L40C	265.2	301.2	304.2	341.2	340	1.2	8	2	
6.7		3	□	MPS1-0670S-DIN	24.2	34.2	42.2	79.2	78	1.2	8	4
		3	●	MPS1-0670S-DIN-C	24.2	34.2	42.2	79.2	78	1.2	8	2
	5	□	MPS1-0670L-DIN	43.2	53.2	54.2	91.2	90	1.2	8	4	
	5	●	MPS1-0670L-DIN-C	43.2	53.2	54.2	91.2	90	1.2	8	2	
	2	●	MPS1-0670-PC	14.5	35.1	37.1	75.1	74	1.1	8	2	
	8	●	MPS1-0670-L8C	55.0	78.4	81.4	118.4	117	1.4	8	2	
	10	□	MPS1-0670-L10C	68.2	92.2	95.2	132.2	131	1.2	8	2	
	12	●	MPS1-0670-L12C	81.6	106.2	109.2	146.2	145	1.2	8	2	
	15	●	MPS1-0670-L15C	101.7	127.2	130.2	167.2	166	1.2	8	2	
	20	□	MPS1-0670-L20C	135.2	162.2	165.2	202.2	201	1.2	8	2	
	25	□	MPS1-0670-L25C	168.7	197.2	200.2	237.2	236	1.2	8	2	
	30	●	MPS1-0670-L30C	202.2	232.2	235.2	272.2	271	1.2	8	2	
	35	□	MPS1-0670-L35C	235.7	267.2	269.2	306.2	305	1.2	8	2	
	40	●	MPS1-0670-L40C	269.2	301.2	304.2	341.2	340	1.2	8	2	
	6.8	3	□	MPS1-0680S-DIN	24.0	34.2	42.2	79.2	78	1.2	8	4
		3	●	MPS1-0680S-DIN-C	24.0	34.2	42.2	79.2	78	1.2	8	2
5		□	MPS1-0680L-DIN	43.0	53.2	54.2	91.2	90	1.2	8	4	
5		●	MPS1-0680L-DIN-C	43.0	53.2	54.2	91.2	90	1.2	8	2	
2		●	MPS1-0680-PC	14.7	35.1	37.1	75.1	74	1.1	8	2	
8		●	MPS1-0680-L8C	55.8	78.4	81.4	118.4	117	1.4	8	2	
10		□	MPS1-0680-L10C	69.2	92.2	95.2	132.2	131	1.2	8	2	
12		●	MPS1-0680-L12C	82.8	106.2	109.2	146.2	145	1.2	8	2	
15		●	MPS1-0680-L15C	103.2	127.2	130.2	167.2	166	1.2	8	2	
20		●	MPS1-0680-L20C	137.2	162.2	165.2	202.2	201	1.2	8	2	
25		●	MPS1-0680-L25C	171.2	197.2	200.2	237.2	236	1.2	8	2	
30		●	MPS1-0680-L30C	205.2	232.2	235.2	272.2	271	1.2	8	2	
35		□	MPS1-0680-L35C	239.2	267.2	269.2	306.2	305	1.2	8	2	
40		●	MPS1-0680-L40C	273.2	301.2	304.2	341.2	340	1.2	8	2	

WIERCENIE (WIERTŁA PEŁNOWĘGLIKOWE)

MPS1

Wiertła z podwójną łysinką i wiertła super długie

WĘGLIKI
SPIEKANE

M
WIERCENIE

DC (mm)	Głębokość otworu (L/D)	DP1021	Numer zamówieniowy	Wymiary (mm)								Typ
				LU	LCF	LH	OAL	LF	PL	DCON		
6.9	3	□	MPS1-0690S-DIN	23.9	34.3	42.3	79.3	78	1.3	8	4	
	3	●	MPS1-0690S-DIN-C	23.9	34.3	42.3	79.3	78	1.3	8	2	
	5	□	MPS1-0690L-DIN	42.9	53.3	54.3	91.3	90	1.3	8	4	
	5	●	MPS1-0690L-DIN-C	42.9	53.3	54.3	91.3	90	1.3	8	2	
	2	●	MPS1-0690-PC	14.9	35.1	37.1	75.1	74	1.1	8	2	
	8	●	MPS1-0690-L8C	56.6	78.4	81.4	118.4	117	1.4	8	2	
	10	□	MPS1-0690-L10C	70.3	92.3	95.3	132.3	131	1.3	8	2	
	12	●	MPS1-0690-L12C	84.1	106.3	109.3	146.3	145	1.3	8	2	
	15	●	MPS1-0690-L15C	104.8	127.3	130.3	167.3	166	1.3	8	2	
	20	●	MPS1-0690-L20C	139.3	162.3	165.3	202.3	201	1.3	8	2	
	25	●	MPS1-0690-L25C	173.8	197.3	200.3	237.3	236	1.3	8	2	
	30	●	MPS1-0690-L30C	208.3	232.3	235.3	272.3	271	1.3	8	2	
35	□	MPS1-0690-L35C	242.8	267.3	269.3	306.3	305	1.3	8	2		
40	●	MPS1-0690-L40C	277.3	301.3	304.3	341.3	340	1.3	8	2		
7.0	3	□	MPS1-0700S-DIN	23.8	34.3	42.3	79.3	78	1.3	8	4	
	3	●	MPS1-0700S-DIN-C	23.8	34.3	42.3	79.3	78	1.3	8	2	
	5	□	MPS1-0700L-DIN	42.8	53.3	54.3	91.3	90	1.3	8	4	
	5	●	MPS1-0700L-DIN-C	42.8	53.3	54.3	91.3	90	1.3	8	2	
	2	●	MPS1-0700-PC	15.1	35.1	37.1	75.1	74	1.1	8	2	
	8	●	MPS1-0700-L8C	57.4	78.4	81.4	118.4	117	1.4	8	2	
	10	●	MPS1-0700-L10C	71.3	92.3	95.3	132.3	131	1.3	8	2	
	12	●	MPS1-0700-L12C	85.3	106.3	109.3	146.3	145	1.3	8	2	
	15	●	MPS1-0700-L15C	106.3	127.3	130.3	167.3	166	1.3	8	2	
	20	●	MPS1-0700-L20C	141.3	162.3	165.3	202.3	201	1.3	8	2	
	25	●	MPS1-0700-L25C	176.3	197.3	200.3	237.3	236	1.3	8	2	
	30	●	MPS1-0700-L30C	211.3	232.3	235.3	272.3	271	1.3	8	2	
35	□	MPS1-0700-L35C	246.3	267.3	269.3	306.3	305	1.3	8	2		
40	●	MPS1-0700-L40C	281.3	301.3	304.3	341.3	340	1.3	8	2		
7.1	3	□	MPS1-0710S-DIN	30.6	41.3	42.3	79.3	78	1.3	8	4	
	3	●	MPS1-0710S-DIN-C	30.6	41.3	42.3	79.3	78	1.3	8	2	
	5	□	MPS1-0710L-DIN	42.6	53.3	54.3	91.3	90	1.3	8	4	
	5	●	MPS1-0710L-DIN-C	42.6	53.3	54.3	91.3	90	1.3	8	2	
	2	●	MPS1-0710-PC	15.3	35.1	38.1	80.1	79	1.1	8	2	
	8	●	MPS1-0710-L8C	58.3	84.5	87.5	124.5	123	1.5	8	2	
	10	□	MPS1-0710-L10C	72.3	99.3	102.3	139.3	138	1.3	8	2	
	12	●	MPS1-0710-L12C	86.5	114.3	117.3	154.3	153	1.3	8	2	
	15	●	MPS1-0710-L15C	107.8	136.3	139.3	176.3	175	1.3	8	2	
	20	●	MPS1-0710-L20C	143.3	174.3	177.3	214.3	213	1.3	8	2	
	25	●	MPS1-0710-L25C	178.8	211.3	214.3	251.3	250	1.3	8	2	
	30	●	MPS1-0710-L30C	214.3	249.3	252.3	289.3	288	1.3	8	2	
35	□	MPS1-0710-L35C	249.8	286.3	288.3	325.3	324	1.3	8	2		
40	●	MPS1-0710-L40C	285.3	321.3	323.3	360.3	359	1.3	8	2		
7.2	3	□	MPS1-0720S-DIN	30.5	41.3	42.3	79.3	78	1.3	8	4	
	3	●	MPS1-0720S-DIN-C	30.5	41.3	42.3	79.3	78	1.3	8	2	
	5	□	MPS1-0720L-DIN	42.5	53.3	54.3	91.3	90	1.3	8	4	
	5	●	MPS1-0720L-DIN-C	42.5	53.3	54.3	91.3	90	1.3	8	2	
	2	●	MPS1-0720-PC	15.5	35.1	38.1	80.1	79	1.1	8	2	
	8	●	MPS1-0720-L8C	59.1	84.5	87.5	124.5	123	1.5	8	2	
	10	□	MPS1-0720-L10C	73.3	99.3	102.3	139.3	138	1.3	8	2	
	12	●	MPS1-0720-L12C	87.7	114.3	117.3	154.3	153	1.3	8	2	
	15	□	MPS1-0720-L15C	109.3	136.3	139.3	176.3	175	1.3	8	2	
	20	□	MPS1-0720-L20C	145.3	174.3	177.3	214.3	213	1.3	8	2	
	25	□	MPS1-0720-L25C	181.3	211.3	214.3	251.3	250	1.3	8	2	
	30	□	MPS1-0720-L30C	217.3	249.3	252.3	289.3	288	1.3	8	2	
35	□	MPS1-0720-L35C	253.3	286.3	288.3	325.3	324	1.3	8	2		
40	●	MPS1-0720-L40C	289.3	321.3	323.3	360.3	359	1.3	8	2		

DC (mm)	Głębokość otworu (L/D)	DP1021	Numer zamówieniowy	Wymiary (mm)								Typ
				LU	LCF	LH	OAL	LF	PL	DCON		
7.3	3	□	MPS1-0730S-DIN	30.4	41.3	42.3	79.3	78	1.3	8	4	
	3	●	MPS1-0730S-DIN-C	30.4	41.3	42.3	79.3	78	1.3	8	2	
	5	□	MPS1-0730L-DIN	42.4	53.3	54.3	91.3	90	1.3	8	4	
	5	●	MPS1-0730L-DIN-C	42.4	53.3	54.3	91.3	90	1.3	8	2	
	2	●	MPS1-0730-PC	15.8	35.2	38.2	80.2	79	1.2	8	2	
	8	●	MPS1-0730-L8C	59.9	84.5	87.5	124.5	123	1.5	8	2	
	10	□	MPS1-0730-L10C	74.3	99.3	102.3	139.3	138	1.3	8	2	
	12	●	MPS1-0730-L12C	88.9	114.3	117.3	154.3	153	1.3	8	2	
	15	□	MPS1-0730-L15C	110.8	136.3	139.3	176.3	175	1.3	8	2	
	20	□	MPS1-0730-L20C	147.3	174.3	177.3	214.3	213	1.3	8	2	
	25	□	MPS1-0730-L25C	183.8	211.3	214.3	251.3	250	1.3	8	2	
	30	□	MPS1-0730-L30C	220.3	249.3	252.3	289.3	288	1.3	8	2	
35	□	MPS1-0730-L35C	256.8	286.3	288.3	325.3	324	1.3	8	2		
40	●	MPS1-0730-L40C	293.3	321.3	323.3	360.3	359	1.3	8	2		
7.4	3	□	MPS1-0740S-DIN	30.2	41.3	42.3	79.3	78	1.3	8	4	
	3	●	MPS1-0740S-DIN-C	30.2	41.3	42.3	79.3	78	1.3	8	2	
	5	□	MPS1-0740L-DIN	42.2	53.3	54.3	91.3	90	1.3	8	4	
	5	●	MPS1-0740L-DIN-C	42.2	53.3	54.3	91.3	90	1.3	8	2	
	2	●	MPS1-0740-PC	16.0	35.2	38.2	80.2	79	1.2	8	2	
	8	●	MPS1-0740-L8C	60.7	84.5	87.5	124.5	123	1.5	8	2	
	10	□	MPS1-0740-L10C	75.3	99.3	102.3	139.3	138	1.3	8	2	
	12	●	MPS1-0740-L12C	90.1	114.3	117.3	154.3	153	1.3	8	2	
	15	□	MPS1-0740-L15C	112.3	136.3	139.3	176.3	175	1.3	8	2	
	20	□	MPS1-0740-L20C	149.3	174.3	177.3	214.3	213	1.3	8	2	
	25	□	MPS1-0740-L25C	186.3	211.3	214.3	251.3	250	1.3	8	2	
	30	□	MPS1-0740-L30C	223.3	249.3	252.3	289.3	288	1.3	8	2	
35	□	MPS1-0740-L35C	260.3	286.3	288.3	325.3	324	1.3	8	2		
40	●	MPS1-0740-L40C	297.3	321.3	323.3	360.3	359	1.3	8	2		
7.5	3	□	MPS1-0750S-DIN	30.1	41.4	42.4	79.4	78	1.4	8	4	
	3	●	MPS1-0750S-DIN-C	30.1	41.4	42.4	79.4	78	1.4	8	2	
	5	□	MPS1-0750L-DIN	42.1	53.4	54.4	91.4	90	1.4	8	4	
	5	●	MPS1-0750L-DIN-C	42.1	53.4	54.4	91.4	90	1.4	8	2	
	2	●	MPS1-0750-PC	16.2	35.2	38.2	80.2	79	1.2	8	2	
	8	●	MPS1-0750-L8C	61.6	84.6	87.6	124.6	123	1.6	8	2	
	10	□	MPS1-0750-L10C	76.4	99.4	102.4	139.4	138	1.4	8	2	
	12	●	MPS1-0750-L12C	91.4	114.4	117.4	154.4	153	1.4	8	2	
	15	●	MPS1-0750-L15C	113.9	136.4	139.4	176.4	175	1.4	8	2	
	20	●	MPS1-0750-L20C	151.4	174.4	177.4	214.4	213	1.4	8	2	
	25	●	MPS1-0750-L25C	188.9	211.4	214.4	251.4	250	1.4	8	2	
	30	●	MPS1-0750-L30C	226.4	249.4	252.4	289.4	288	1.4	8	2	
35	□	MPS1-0750-L35C	263.9	286.4	288.4	325.4	324	1.4	8	2		
40	●	MPS1-0750-L40C	301.4	321.4	323.4	360.4	359	1.4	8	2		
7.6	3	□	MPS1-0760S-DIN	30.0	41.4	42.4	79.4	78	1.4	8	4	
	3	●	MPS1-0760S-DIN-C	30.0	41.4	42.4	79.4	78	1.4	8	2	
	5	□	MPS1-0760L-DIN	42.0	53.4	54.4	91.4	90	1.4	8	4	
	5	●	MPS1-0760L-DIN-C	42.0	53.4	54.4	91.4	90	1.4	8	2	
	2	●	MPS1-0760-PC	16.4	38.2	38.2	80.2	79	1.2	8	2	
	8	●	MPS1-0760-L8C	62.4	89.6	92.6	129.6	128	1.6	8	2	
	10	□	MPS1-0760-L10C	77.4	105.4	108.4	145.4	144	1.4	8	2	
	12	●	MPS1-0760-L12C	92.6	121.4	124.4	161.4	160	1.4	8	2	
	15	●	MPS1-0760-L15C	115.4	145.4	148.4	185.4	184	1.4	8	2	
	20	□	MPS1-0760-L20C	153.4	185.4	188.4	225.4	224	1.4	8	2	
	25	●	MPS1-0760-L25C	191.4	225.4	228.4	265.4	264	1.4	8	2	
	30	□	MPS1-0760-L30C	229.4	265.4	268.4	305.4	304	1.4	8	2	
35	□	MPS1-0760-L35C	267.4	305.4	307.4	344.4	343	1.4	8	2		
40	●	MPS1-0760-L40C	305.4	341.4	342.4	379.4	378	1.4	8	2		

● : Standard magazynowy. □ : Niestandardowy, produkowany na specjalne zamówienie.

DC (mm)	Głębokość otworu (L/D)	DP1021	Numer zamówieniowy	Wymiary (mm)							Typ	
				LU	LCF	LH	OAL	LF	PL	DCON		
7.7	3	□	MPS1-0770S-DIN	29.9	41.4	42.4	79.4	78	1.4	8	4	
	3	●	MPS1-0770S-DIN-C	29.9	41.4	42.4	79.4	78	1.4	8	2	
	5	□	MPS1-0770L-DIN	41.9	53.4	54.4	91.4	90	1.4	8	4	
	5	●	MPS1-0770L-DIN-C	41.9	53.4	54.4	91.4	90	1.4	8	2	
	2	●	MPS1-0770-PC	16.6	38.2	38.2	80.2	79	1.2	8	2	
	8	●	MPS1-0770-L8C	63.2	89.6	92.6	129.6	128	1.6	8	2	
	10	□	MPS1-0770-L10C	78.4	105.4	108.4	145.4	144	1.4	8	2	
	12	●	MPS1-0770-L12C	93.8	121.4	124.4	161.4	160	1.4	8	2	
	15	●	MPS1-0770-L15C	116.9	145.4	148.4	185.4	184	1.4	8	2	
	20	□	MPS1-0770-L20C	155.4	185.4	188.4	225.4	224	1.4	8	2	
	25	●	MPS1-0770-L25C	193.9	225.4	228.4	265.4	264	1.4	8	2	
	30	□	MPS1-0770-L30C	232.4	265.4	268.4	305.4	304	1.4	8	2	
	35	□	MPS1-0770-L35C	270.9	305.4	307.4	344.4	343	1.4	8	2	
	40	●	MPS1-0770-L40C	309.4	341.4	342.4	379.4	378	1.4	8	2	
	7.8	3	□	MPS1-0780S-DIN	29.7	41.4	42.4	79.4	78	1.4	8	4
		3	●	MPS1-0780S-DIN-C	29.7	41.4	42.4	79.4	78	1.4	8	2
5		□	MPS1-0780L-DIN	41.7	53.4	54.4	91.4	90	1.4	8	4	
5		●	MPS1-0780L-DIN-C	41.7	53.4	54.4	91.4	90	1.4	8	2	
2		●	MPS1-0780-PC	16.8	38.2	38.2	80.2	79	1.2	8	2	
8		●	MPS1-0780-L8C	64.0	89.6	92.6	129.6	128	1.6	8	2	
10		□	MPS1-0780-L10C	79.4	105.4	108.4	145.4	144	1.4	8	2	
12		●	MPS1-0780-L12C	95.0	121.4	124.4	161.4	160	1.4	8	2	
15		●	MPS1-0780-L15C	118.4	145.4	148.4	185.4	184	1.4	8	2	
20		□	MPS1-0780-L20C	157.4	185.4	188.4	225.4	224	1.4	8	2	
25		□	MPS1-0780-L25C	196.4	225.4	228.4	265.4	264	1.4	8	2	
30		●	MPS1-0780-L30C	235.4	265.4	268.4	305.4	304	1.4	8	2	
35		□	MPS1-0780-L35C	274.4	305.4	307.4	344.4	343	1.4	8	2	
40		●	MPS1-0780-L40C	313.4	341.4	342.4	379.4	378	1.4	8	2	
7.9		3	□	MPS1-0790S-DIN	29.6	41.4	42.4	79.4	78	1.4	8	4
		3	●	MPS1-0790S-DIN-C	29.6	41.4	42.4	79.4	78	1.4	8	2
	5	□	MPS1-0790L-DIN	41.6	53.4	54.4	91.4	90	1.4	8	4	
	5	●	MPS1-0790L-DIN-C	41.6	53.4	54.4	91.4	90	1.4	8	2	
	2	●	MPS1-0790-PC	17.0	38.2	38.2	80.2	79	1.2	8	2	
	8	●	MPS1-0790-L8C	64.8	89.6	92.6	129.6	128	1.6	8	2	
	10	□	MPS1-0790-L10C	80.4	105.4	108.4	145.4	144	1.4	8	2	
	12	●	MPS1-0790-L12C	96.2	121.4	124.4	161.4	160	1.4	8	2	
	15	□	MPS1-0790-L15C	119.9	145.4	148.4	185.4	184	1.4	8	2	
	20	□	MPS1-0790-L20C	159.4	185.4	188.4	225.4	224	1.4	8	2	
	25	●	MPS1-0790-L25C	198.9	225.4	228.4	265.4	264	1.4	8	2	
	30	●	MPS1-0790-L30C	238.4	265.4	268.4	305.4	304	1.4	8	2	
	35	□	MPS1-0790-L35C	277.9	305.4	307.4	344.4	343	1.4	8	2	
	40	●	MPS1-0790-L40C	317.4	341.4	342.4	379.4	378	1.4	8	2	
	8.0	3	□	MPS1-0800S-DIN	29.5	41.5	42.5	79.5	78	1.5	8	4
		3	●	MPS1-0800S-DIN-C	29.5	41.5	42.5	79.5	78	1.5	8	2
5		□	MPS1-0800L-DIN	41.5	53.5	54.5	91.5	90	1.5	8	4	
5		●	MPS1-0800L-DIN-C	41.5	53.5	54.5	91.5	90	1.5	8	2	
2		●	MPS1-0800-PC	17.3	38.3	38.3	80.3	79	1.3	8	2	
8		●	MPS1-0800-L8C	65.7	89.7	92.7	129.7	128	1.7	8	2	
10		●	MPS1-0800-L10C	81.5	105.5	108.5	145.5	144	1.5	8	2	
12		●	MPS1-0800-L12C	97.5	121.5	124.5	161.5	160	1.5	8	2	
15		●	MPS1-0800-L15C	121.5	145.5	148.5	185.5	184	1.5	8	2	
20		●	MPS1-0800-L20C	161.5	185.5	188.5	225.5	224	1.5	8	2	
25		●	MPS1-0800-L25C	201.5	225.5	228.5	265.5	264	1.5	8	2	
30		●	MPS1-0800-L30C	241.5	265.5	268.5	305.5	304	1.5	8	2	
35		□	MPS1-0800-L35C	281.5	305.5	307.5	344.5	343	1.5	8	2	
40		●	MPS1-0800-L40C	321.5	341.5	342.5	379.5	378	1.5	8	2	

DC (mm)	Głębokość otworu (L/D)	DP1021	Numer zamówieniowy	Wymiary (mm)							Typ	
				LU	LCF	LH	OAL	LF	PL	DCON		
8.05	3	□	MPS1-0805S-DIN	34.4	46.5	47.5	88.5	87	1.5	10	4	
	3	●	MPS1-0805S-DIN-C	34.4	46.5	47.5	88.5	87	1.5	10	2	
	5	□	MPS1-0805L-DIN	48.4	60.5	61.5	102.5	101	1.5	10	4	
	5	●	MPS1-0805L-DIN-C	48.4	60.5	61.5	102.5	101	1.5	10	2	
	3	□	MPS1-0810S-DIN	34.3	46.5	47.5	88.5	87	1.5	10	4	
8.1	3	●	MPS1-0810S-DIN-C	34.3	46.5	47.5	88.5	87	1.5	10	2	
	5	□	MPS1-0810L-DIN	48.3	60.5	61.5	102.5	101	1.5	10	4	
	5	●	MPS1-0810L-DIN-C	48.3	60.5	61.5	102.5	101	1.5	10	2	
	2	●	MPS1-0810-PC	17.5	38.3	41.3	85.3	84	1.3	10	2	
	8	●	MPS1-0810-L8C	66.5	95.7	98.7	139.7	138	1.7	10	2	
	10	□	MPS1-0810-L10C	82.5	112.5	115.5	156.5	155	1.5	10	2	
	12	●	MPS1-0810-L12C	98.7	129.5	132.5	173.5	172	1.5	10	2	
	15	●	MPS1-0810-L15C	123.0	154.5	157.5	198.5	197	1.5	10	2	
	20	●	MPS1-0810-L20C	163.5	197.5	200.5	241.5	240	1.5	10	2	
	25	□	MPS1-0810-L25C	204.0	239.5	242.5	283.5	282	1.5	10	2	
	30	□	MPS1-0810-L30C	244.5	282.5	284.5	325.5	324	1.5	10	2	
	35	□	MPS1-0810-L35C	285.0	324.5	326.5	367.5	366	1.5	10	2	
	40	●	MPS1-0810-L40C	325.5	366.5	370.5	411.5	410	1.5	10	2	
	8.2	3	□	MPS1-0820S-DIN	34.2	46.5	47.5	88.5	87	1.5	10	4
		3	●	MPS1-0820S-DIN-C	34.2	46.5	47.5	88.5	87	1.5	10	2
		5	□	MPS1-0820L-DIN	48.2	60.5	61.5	102.5	101	1.5	10	4
5		●	MPS1-0820L-DIN-C	48.2	60.5	61.5	102.5	101	1.5	10	2	
2		●	MPS1-0820-PC	17.7	38.3	41.3	85.3	84	1.3	10	2	
8		●	MPS1-0820-L8C	67.3	95.7	98.7	139.7	138	1.7	10	2	
10		□	MPS1-0820-L10C	83.5	112.5	115.5	156.5	155	1.5	10	2	
12		●	MPS1-0820-L12C	99.9	129.5	132.5	173.5	172	1.5	10	2	
15		●	MPS1-0820-L15C	124.5	154.5	157.5	198.5	197	1.5	10	2	
20		●	MPS1-0820-L20C	165.5	197.5	200.5	241.5	240	1.5	10	2	
25		□	MPS1-0820-L25C	206.5	239.5	242.5	283.5	282	1.5	10	2	
30		□	MPS1-0820-L30C	247.5	282.5	284.5	325.5	324	1.5	10	2	
35		□	MPS1-0820-L35C	288.5	324.5	326.5	367.5	366	1.5	10	2	
40		●	MPS1-0820-L40C	329.5	366.5	370.5	411.5	410	1.5	10	2	
8.3		3	□	MPS1-0830S-DIN	34.1	46.5	47.5	88.5	87	1.5	10	4
		3	●	MPS1-0830S-DIN-C	34.1	46.5	47.5	88.5	87	1.5	10	2
	5	□	MPS1-0830L-DIN	48.1	60.5	61.5	102.5	101	1.5	10	4	
	5	●	MPS1-0830L-DIN-C	48.1	60.5	61.5	102.5	101	1.5	10	2	
	2	●	MPS1-0830-PC	17.9	38.3	41.3	85.3	84	1.3	10	2	
	8	●	MPS1-0830-L8C	68.1	95.7	98.7	139.7	138	1.7	10	2	
	10	□	MPS1-0830-L10C	84.5	112.5	115.5	156.5	155	1.5	10	2	
	12	●	MPS1-0830-L12C	101.1	129.5	132.5	173.5	172	1.5	10	2	
	15	□	MPS1-0830-L15C	126.0	154.5	157.5	198.5	197	1.5	10	2	
	20	□	MPS1-0830-L20C	167.5	197.5	200.5	241.5	240	1.5	10	2	
	25	□	MPS1-0830-L25C	209.0	239.5	242.5	283.5	282	1.5	10	2	
	30	□	MPS1-0830-L30C	250.5	282.5	284.5	325.5	324	1.5	10	2	
	35	□	MPS1-0830-L35C	292.0	324.5	326.5	367.5	366	1.5	10	2	
	40	●	MPS1-0830-L40C	333.5	366.5	370.5	411.5	410	1.5	10	2	

WIERCENIE (WIERTŁA PEŁNOWĘGLIKOWE)

MPS1

Wiertła z podwójną łysinką i wiertła super długie

WĘGLIKI
SPIEKANE

M
WIERCENIE

DC (mm)	Głębokość otworu (L/D)	DP1021	Numer zamówieniowy	Wymiary (mm)							Typ
				LU	LCF	LH	OAL	LF	PL	DCON	
8.4	3	□	MPS1-0840S-DIN	33.9	46.5	47.5	88.5	87	1.5	10	4
	3	●	MPS1-0840S-DIN-C	33.9	46.5	47.5	88.5	87	1.5	10	2
	5	□	MPS1-0840L-DIN	47.9	60.5	61.5	102.5	101	1.5	10	4
	5	●	MPS1-0840L-DIN-C	47.9	60.5	61.5	102.5	101	1.5	10	2
	2	●	MPS1-0840-PC	18.1	38.3	41.3	85.3	84	1.3	10	2
	8	●	MPS1-0840-L8C	68.9	95.7	98.7	139.7	138	1.7	10	2
	10	□	MPS1-0840-L10C	85.5	112.5	115.5	156.5	155	1.5	10	2
	12	●	MPS1-0840-L12C	102.3	129.5	132.5	173.5	172	1.5	10	2
	15	●	MPS1-0840-L15C	127.5	154.5	157.5	198.5	197	1.5	10	2
	20	□	MPS1-0840-L20C	169.5	197.5	200.5	241.5	240	1.5	10	2
	25	□	MPS1-0840-L25C	211.5	239.5	242.5	283.5	282	1.5	10	2
	30	□	MPS1-0840-L30C	253.5	282.5	284.5	325.5	324	1.5	10	2
35	□	MPS1-0840-L35C	295.5	324.5	326.5	367.5	366	1.5	10	2	
40	●	MPS1-0840-L40C	337.5	366.5	370.5	411.5	410	1.5	10	2	
8.5	3	□	MPS1-0850S-DIN	33.8	46.5	47.5	88.5	87	1.5	10	4
	3	●	MPS1-0850S-DIN-C	33.8	46.5	47.5	88.5	87	1.5	10	2
	5	□	MPS1-0850L-DIN	47.8	60.5	61.5	102.5	101	1.5	10	4
	5	●	MPS1-0850L-DIN-C	47.8	60.5	61.5	102.5	101	1.5	10	2
	2	●	MPS1-0850-PC	18.3	38.3	41.3	85.3	84	1.3	10	2
	8	●	MPS1-0850-L8C	69.8	95.8	98.8	139.8	138	1.8	10	2
	10	□	MPS1-0850-L10C	86.5	112.5	115.5	156.5	155	1.5	10	2
	12	●	MPS1-0850-L12C	103.5	129.5	132.5	173.5	172	1.5	10	2
	15	●	MPS1-0850-L15C	129.0	154.5	157.5	198.5	197	1.5	10	2
	20	●	MPS1-0850-L20C	171.5	197.5	200.5	241.5	240	1.5	10	2
	25	●	MPS1-0850-L25C	214.0	239.5	242.5	283.5	282	1.5	10	2
	30	●	MPS1-0850-L30C	256.5	282.5	284.5	325.5	324	1.5	10	2
35	□	MPS1-0850-L35C	299.0	324.5	326.5	367.5	366	1.5	10	2	
40	●	MPS1-0850-L40C	341.5	366.5	370.5	411.5	410	1.5	10	2	
8.6	3	□	MPS1-0860S-DIN	33.7	46.6	47.6	88.6	87	1.6	10	4
	3	●	MPS1-0860S-DIN-C	33.7	46.6	47.6	88.6	87	1.6	10	2
	5	□	MPS1-0860L-DIN	47.7	60.6	61.6	102.6	101	1.6	10	4
	5	●	MPS1-0860L-DIN-C	47.7	60.6	61.6	102.6	101	1.6	10	2
	2	●	MPS1-0860-PC	18.6	41.4	43.4	85.4	84	1.4	10	2
	8	●	MPS1-0860-L8C	70.6	100.8	103.8	144.8	143	1.8	10	2
	10	□	MPS1-0860-L10C	87.6	118.6	121.6	162.6	161	1.6	10	2
	12	●	MPS1-0860-L12C	104.8	136.6	139.6	180.6	179	1.6	10	2
	15	●	MPS1-0860-L15C	130.6	163.6	166.6	207.6	206	1.6	10	2
	20	□	MPS1-0860-L20C	173.6	208.6	211.6	252.6	251	1.6	10	2
	25	●	MPS1-0860-L25C	216.6	253.6	256.6	297.6	296	1.6	10	2
	30	●	MPS1-0860-L30C	259.6	298.6	300.6	341.6	340	1.6	10	2
35	□	MPS1-0860-L35C	302.6	343.6	345.6	386.6	385	1.6	10	2	
40	●	MPS1-0860-L40C	345.6	391.6	394.6	435.6	434	1.6	10	2	
8.7	3	□	MPS1-0870S-DIN	33.5	46.6	47.6	88.6	87	1.6	10	4
	3	●	MPS1-0870S-DIN-C	33.5	46.6	47.6	88.6	87	1.6	10	2
	5	□	MPS1-0870L-DIN	47.5	60.6	61.6	102.6	101	1.6	10	4
	5	●	MPS1-0870L-DIN-C	47.5	60.6	61.6	102.6	101	1.6	10	2
	2	●	MPS1-0870-PC	18.8	41.4	43.4	85.4	84	1.4	10	2
	8	●	MPS1-0870-L8C	71.4	100.8	103.8	144.8	143	1.8	10	2
	10	□	MPS1-0870-L10C	88.6	118.6	121.6	162.6	161	1.6	10	2
	12	●	MPS1-0870-L12C	106.0	136.6	139.6	180.6	179	1.6	10	2
	15	●	MPS1-0870-L15C	132.1	163.6	166.6	207.6	206	1.6	10	2
	20	□	MPS1-0870-L20C	175.6	208.6	211.6	252.6	251	1.6	10	2
	25	●	MPS1-0870-L25C	219.1	253.6	256.6	297.6	296	1.6	10	2
	30	□	MPS1-0870-L30C	262.6	298.6	300.6	341.6	340	1.6	10	2
35	□	MPS1-0870-L35C	306.1	343.6	345.6	386.6	385	1.6	10	2	
40	●	MPS1-0870-L40C	349.6	391.6	394.6	435.6	434	1.6	10	2	

DC (mm)	Głębokość otworu (L/D)	DP1021	Numer zamówieniowy	Wymiary (mm)							Typ
				LU	LCF	LH	OAL	LF	PL	DCON	
8.8	3	□	MPS1-0880S-DIN	33.4	46.6	47.6	88.6	87	1.6	10	4
	3	●	MPS1-0880S-DIN-C	33.4	46.6	47.6	88.6	87	1.6	10	2
	5	□	MPS1-0880L-DIN	47.4	60.6	61.6	102.6	101	1.6	10	4
	5	●	MPS1-0880L-DIN-C	47.4	60.6	61.6	102.6	101	1.6	10	2
	2	●	MPS1-0880-PC	19.0	41.4	43.4	85.4	84	1.4	10	2
	8	●	MPS1-0880-L8C	72.2	100.8	103.8	144.8	143	1.8	10	2
	10	□	MPS1-0880-L10C	89.6	118.6	121.6	162.6	161	1.6	10	2
	12	●	MPS1-0880-L12C	107.2	136.6	139.6	180.6	179	1.6	10	2
	15	●	MPS1-0880-L15C	133.6	163.6	166.6	207.6	206	1.6	10	2
	20	●	MPS1-0880-L20C	177.6	208.6	211.6	252.6	251	1.6	10	2
	25	●	MPS1-0880-L25C	221.6	253.6	256.6	297.6	296	1.6	10	2
	30	●	MPS1-0880-L30C	265.6	298.6	300.6	341.6	340	1.6	10	2
35	□	MPS1-0880-L35C	309.6	343.6	345.6	386.6	385	1.6	10	2	
40	●	MPS1-0880-L40C	353.6	391.6	394.6	435.6	434	1.6	10	2	
8.9	3	□	MPS1-0890S-DIN	33.3	46.6	47.6	88.6	87	1.6	10	4
	3	●	MPS1-0890S-DIN-C	33.3	46.6	47.6	88.6	87	1.6	10	2
	5	□	MPS1-0890L-DIN	47.3	60.6	61.6	102.6	101	1.6	10	4
	5	●	MPS1-0890L-DIN-C	47.3	60.6	61.6	102.6	101	1.6	10	2
	2	●	MPS1-0890-PC	19.2	41.4	43.4	85.4	84	1.4	10	2
	8	●	MPS1-0890-L8C	73.0	100.8	103.8	144.8	143	1.8	10	2
	10	□	MPS1-0890-L10C	90.6	118.6	121.6	162.6	161	1.6	10	2
	12	●	MPS1-0890-L12C	108.4	136.6	139.6	180.6	179	1.6	10	2
	15	□	MPS1-0890-L15C	135.1	163.6	166.6	207.6	206	1.6	10	2
	20	□	MPS1-0890-L20C	179.6	208.6	211.6	252.6	251	1.6	10	2
	25	□	MPS1-0890-L25C	224.1	253.6	256.6	297.6	296	1.6	10	2
	30	□	MPS1-0890-L30C	268.6	298.6	300.6	341.6	340	1.6	10	2
35	□	MPS1-0890-L35C	313.1	343.6	345.6	386.6	385	1.6	10	2	
40	●	MPS1-0890-L40C	357.6	391.6	394.6	435.6	434	1.6	10	2	
9.0	3	□	MPS1-0900S-DIN	33.1	46.6	47.6	88.6	87	1.6	10	4
	3	●	MPS1-0900S-DIN-C	33.1	46.6	47.6	88.6	87	1.6	10	2
	5	□	MPS1-0900L-DIN	47.1	60.6	61.6	102.6	101	1.6	10	4
	5	●	MPS1-0900L-DIN-C	47.1	60.6	61.6	102.6	101	1.6	10	2
	2	●	MPS1-0900-PC	19.4	41.4	43.4	85.4	84	1.4	10	2
	8	●	MPS1-0900-L8C	73.9	100.9	103.9	144.9	143	1.9	10	2
	10	□	MPS1-0900-L10C	91.6	118.6	121.6	162.6	161	1.6	10	2
	12	●	MPS1-0900-L12C	109.6	136.6	139.6	180.6	179	1.6	10	2
	15	●	MPS1-0900-L15C	136.6	163.6	166.6	207.6	206	1.6	10	2
	20	●	MPS1-0900-L20C	181.6	208.6	211.6	252.6	251	1.6	10	2
	25	●	MPS1-0900-L25C	226.6	253.6	256.6	297.6	296	1.6	10	2
	30	●	MPS1-0900-L30C	271.6	298.6	300.6	341.6	340	1.6	10	2
35	□	MPS1-0900-L35C	316.6	343.6	345.6	386.6	385	1.6	10	2	
40	●	MPS1-0900-L40C	361.6	391.6	394.6	435.6	434	1.6	10	2	
9.1	3	□	MPS1-0910S-DIN	33.0	46.7	47.7	88.7	87	1.7	10	4
	3	●	MPS1-0910S-DIN-C	33.0	46.7	47.7	88.7	87	1.7	10	2
	5	□	MPS1-0910L-DIN	47.0	60.7	61.7	102.7	101	1.7	10	4
	5	●	MPS1-0910L-DIN-C	47.0	60.7	61.7	102.7	101	1.7	10	2
	2	●	MPS1-0910-PC	19.6	41.4	44.4	90.4	89	1.4	10	2
	8	●	MPS1-0910-L8C	74.7	106.9	109.9	150.9	149	1.9	10	2
	10	□	MPS1-0910-L10C	92.7	125.7	128.7	169.7	168	1.7	10	2
	12	●	MPS1-0910-L12C	110.9	144.7	147.7	188.7	187	1.7	10	2
	15	●	MPS1-0910-L15C	138.2	172.7	175.7	216.7	215	1.7	10	2
	20	□	MPS1-0910-L20C	183.7	220.7	223.7	264.7	263	1.7	10	2
	25	□	MPS1-0910-L25C	229.2	267.7	270.7	311.7	310	1.7	10	2
	30	●	MPS1-0910-L30C	274.7	315.7	318.7	359.7	358	1.7	10	2
35	□	MPS1-0910-L35C	320.2	362.7	364.7	405.7	404	1.7	10	2	

● : Standard magazynowy. □ : Niestandardowy, produkowany na specjalne zamówienie.

DC	Ciepłota otworu (mm)	DP1021 (L/D)	Numer zamówieniowy	Wymiary (mm)							Typ
				LU	LCF	LH	OAL	LF	PL	DCON	
9.2	3	□	MPS1-0920S-DIN	32.9	46.7	47.7	88.7	87	1.7	10	4
	3	●	MPS1-0920S-DIN-C	32.9	46.7	47.7	88.7	87	1.7	10	2
	5	□	MPS1-0920L-DIN	46.9	60.7	61.7	102.7	101	1.7	10	4
	5	●	MPS1-0920L-DIN-C	46.9	60.7	61.7	102.7	101	1.7	10	2
	2	●	MPS1-0920-PC	19.9	41.5	44.5	90.5	89	1.5	10	2
	8	●	MPS1-0920-L8C	75.5	106.9	109.9	150.9	149	1.9	10	2
	10	□	MPS1-0920-L10C	93.7	125.7	128.7	169.7	168	1.7	10	2
	12	●	MPS1-0920-L12C	112.1	144.7	147.7	188.7	187	1.7	10	2
	15	●	MPS1-0920-L15C	139.7	172.7	175.7	216.7	215	1.7	10	2
	20	□	MPS1-0920-L20C	185.7	220.7	223.7	264.7	263	1.7	10	2
	25	□	MPS1-0920-L25C	231.7	267.7	270.7	311.7	310	1.7	10	2
	30	□	MPS1-0920-L30C	277.7	315.7	318.7	359.7	358	1.7	10	2
	35	□	MPS1-0920-L35C	323.7	362.7	364.7	405.7	404	1.7	10	2
	9.3	3	□	MPS1-0930S-DIN	32.7	46.7	47.7	88.7	87	1.7	10
3		●	MPS1-0930S-DIN-C	32.7	46.7	47.7	88.7	87	1.7	10	2
5		□	MPS1-0930L-DIN	46.7	60.7	61.7	102.7	101	1.7	10	4
5		●	MPS1-0930L-DIN-C	46.7	60.7	61.7	102.7	101	1.7	10	2
2		●	MPS1-0930-PC	20.1	41.5	44.5	90.5	89	1.5	10	2
8		●	MPS1-0930-L8C	76.3	106.9	109.9	150.9	149	1.9	10	2
10		□	MPS1-0930-L10C	94.7	125.7	128.7	169.7	168	1.7	10	2
12		●	MPS1-0930-L12C	113.3	144.7	147.7	188.7	187	1.7	10	2
15		□	MPS1-0930-L15C	141.2	172.7	175.7	216.7	215	1.7	10	2
20		□	MPS1-0930-L20C	187.7	220.7	223.7	264.7	263	1.7	10	2
25		□	MPS1-0930-L25C	234.2	267.7	270.7	311.7	310	1.7	10	2
30		□	MPS1-0930-L30C	280.7	315.7	318.7	359.7	358	1.7	10	2
35		□	MPS1-0930-L35C	327.2	362.7	364.7	405.7	404	1.7	10	2
9.4		3	□	MPS1-0940S-DIN	32.6	46.7	47.7	88.7	87	1.7	10
	3	●	MPS1-0940S-DIN-C	32.6	46.7	47.7	88.7	87	1.7	10	2
	5	□	MPS1-0940L-DIN	46.6	60.7	61.7	102.7	101	1.7	10	4
	5	●	MPS1-0940L-DIN-C	46.6	60.7	61.7	102.7	101	1.7	10	2
	2	●	MPS1-0940-PC	20.3	41.5	44.5	90.5	89	1.5	10	2
	8	●	MPS1-0940-L8C	77.1	106.9	109.9	150.9	149	1.9	10	2
	10	□	MPS1-0940-L10C	95.7	125.7	128.7	169.7	168	1.7	10	2
	12	●	MPS1-0940-L12C	114.5	144.7	147.7	188.7	187	1.7	10	2
	15	□	MPS1-0940-L15C	142.7	172.7	175.7	216.7	215	1.7	10	2
	20	□	MPS1-0940-L20C	189.7	220.7	223.7	264.7	263	1.7	10	2
	25	□	MPS1-0940-L25C	236.7	267.7	270.7	311.7	310	1.7	10	2
	30	□	MPS1-0940-L30C	283.7	315.7	318.7	359.7	358	1.7	10	2
	35	□	MPS1-0940-L35C	330.7	362.7	364.7	405.7	404	1.7	10	2
	9.5	3	□	MPS1-0950S-DIN	32.5	46.7	47.7	88.7	87	1.7	10
3		●	MPS1-0950S-DIN-C	32.5	46.7	47.7	88.7	87	1.7	10	2
5		□	MPS1-0950L-DIN	46.5	60.7	61.7	102.7	101	1.7	10	4
5		●	MPS1-0950L-DIN-C	46.5	60.7	61.7	102.7	101	1.7	10	2
2		●	MPS1-0950-PC	20.5	41.5	44.5	90.5	89	1.5	10	2
8		●	MPS1-0950-L8C	78.0	107.0	110.0	151.0	149	2.0	10	2
10		□	MPS1-0950-L10C	96.7	125.7	128.7	169.7	168	1.7	10	2
12		●	MPS1-0950-L12C	115.7	144.7	147.7	188.7	187	1.7	10	2
15		●	MPS1-0950-L15C	144.2	172.7	175.7	216.7	215	1.7	10	2
20		●	MPS1-0950-L20C	191.7	220.7	223.7	264.7	263	1.7	10	2
25		●	MPS1-0950-L25C	239.2	267.7	270.7	311.7	310	1.7	10	2
30		●	MPS1-0950-L30C	286.7	315.7	318.7	359.7	358	1.7	10	2
35		□	MPS1-0950-L35C	334.2	362.7	364.7	405.7	404	1.7	10	2

DC	Ciepłota otworu (mm)	DP1021 (L/D)	Numer zamówieniowy	Wymiary (mm)							Typ
				LU	LCF	LH	OAL	LF	PL	DCON	
9.6	3	□	MPS1-0960S-DIN	32.3	46.7	47.7	88.7	87	1.7	10	4
	3	●	MPS1-0960S-DIN-C	32.3	46.7	47.7	88.7	87	1.7	10	2
	5	□	MPS1-0960L-DIN	46.3	60.7	61.7	102.7	101	1.7	10	4
	5	●	MPS1-0960L-DIN-C	46.3	60.7	61.7	102.7	101	1.7	10	2
	2	●	MPS1-0960-PC	20.7	44.5	44.5	90.5	89	1.5	10	2
	8	●	MPS1-0960-L8C	78.8	112.0	115.0	156.0	154	2.0	10	2
	10	□	MPS1-0960-L10C	97.7	131.7	134.7	175.7	174	1.7	10	2
	12	●	MPS1-0960-L12C	116.9	151.7	154.7	195.7	194	1.7	10	2
	15	●	MPS1-0960-L15C	145.7	181.7	184.7	225.7	224	1.7	10	2
	20	□	MPS1-0960-L20C	193.7	231.7	234.7	275.7	274	1.7	10	2
	25	□	MPS1-0960-L25C	241.7	281.7	284.7	325.7	324	1.7	10	2
	30	□	MPS1-0960-L30C	289.7	331.7	334.7	375.7	374	1.7	10	2
	35	□	MPS1-0960-L35C	337.7	381.7	383.7	424.7	423	1.7	10	2
	9.7	3	□	MPS1-0970S-DIN	32.2	46.8	47.8	88.8	87	1.8	10
3		●	MPS1-0970S-DIN-C	32.2	46.8	47.8	88.8	87	1.8	10	2
5		□	MPS1-0970L-DIN	46.2	60.8	61.8	102.8	101	1.8	10	4
5		●	MPS1-0970L-DIN-C	46.2	60.8	61.8	102.8	101	1.8	10	2
2		●	MPS1-0970-PC	20.9	44.5	44.5	90.5	89	1.5	10	2
8		●	MPS1-0970-L8C	79.6	112.0	115.0	156.0	154	2.0	10	2
10		□	MPS1-0970-L10C	98.8	131.8	134.8	175.8	174	1.8	10	2
12		●	MPS1-0970-L12C	118.2	151.8	154.8	195.8	194	1.8	10	2
15		●	MPS1-0970-L15C	147.3	181.8	184.8	225.8	224	1.8	10	2
20		□	MPS1-0970-L20C	195.8	231.8	234.8	275.8	274	1.8	10	2
25		□	MPS1-0970-L25C	244.3	281.8	284.8	325.8	324	1.8	10	2
30		□	MPS1-0970-L30C	292.8	331.8	334.8	375.8	374	1.8	10	2
35		□	MPS1-0970-L35C	341.3	381.8	383.8	424.8	423	1.8	10	2
9.8		3	□	MPS1-0980S-DIN	32.1	46.8	47.8	88.8	87	1.8	10
	3	●	MPS1-0980S-DIN-C	32.1	46.8	47.8	88.8	87	1.8	10	2
	5	□	MPS1-0980L-DIN	46.1	60.8	61.8	102.8	101	1.8	10	4
	5	●	MPS1-0980L-DIN-C	46.1	60.8	61.8	102.8	101	1.8	10	2
	2	●	MPS1-0980-PC	21.1	44.5	44.5	90.5	89	1.5	10	2
	8	●	MPS1-0980-L8C	80.4	112.0	115.0	156.0	154	2.0	10	2
	10	□	MPS1-0980-L10C	99.8	131.8	134.8	175.8	174	1.8	10	2
	12	●	MPS1-0980-L12C	119.4	151.8	154.8	195.8	194	1.8	10	2
	15	●	MPS1-0980-L15C	148.8	181.8	184.8	225.8	224	1.8	10	2
	20	●	MPS1-0980-L20C	197.8	231.8	234.8	275.8	274	1.8	10	2
	25	□	MPS1-0980-L25C	246.8	281.8	284.8	325.8	324	1.8	10	2
	30	●	MPS1-0980-L30C	295.8	331.8	334.8	375.8	374	1.8	10	2
	35	□	MPS1-0980-L35C	344.8	381.8	383.8	424.8	423	1.8	10	2
	9.9	3	□	MPS1-0990S-DIN	32.0	46.8	47.8	88.8	87	1.8	10
3		●	MPS1-0990S-DIN-C	32.0	46.8	47.8	88.8	87	1.8	10	2
5		□	MPS1-0990L-DIN	46.0	60.8	61.8	102.8	101	1.8	10	4
5		●	MPS1-0990L-DIN-C	46.0	60.8	61.8	102.8	101	1.8	10	2
2		●	MPS1-0990-PC	21.4	44.6	44.6	90.6	89	1.6	10	2
8		●	MPS1-0990-L8C	81.3	112.1	115.1	156.1	154	2.1	10	2
10		□	MPS1-0990-L10C	100.8	131.8	134.8	175.8	174	1.8	10	2
12		●	MPS1-0990-L12C	120.6	151.8	154.8	195.8	194	1.8	10	2
15		●	MPS1-0990-L15C	150.3	181.8	184.8	225.8	224	1.8	10	2
20		□	MPS1-0990-L20C	199.8	231.8	234.8	275.8	274	1.8	10	2
25		□	MPS1-0990-L25C	249.3	281.8	284.8	325.8	324	1.8	10	2
30		□	MPS1-0990-L30C	298.8	331.8	334.8	375.8	374	1.8	10	2
35		□	MPS1-0990-L35C	348.3	381.8	383.8	424.8	423	1.8	10	2

WIERCENIE (WIERTŁA PEŁNOWĘGLIKOWE)

MPS1

Wiertła z podwójną łysinką
i wiertła super długie

WĘGLIKI
SPIEKANE

M
WIERCENIE

DC (mm)	Głębokość otworu (L/D)	DP1021	Numer zamówieniowy	Wymiary (mm)								Typ
				LU	LCF	LH	OAL	LF	PL	DCON		
10.0	3	□	MPS1-1000S-DIN	31.8	46.8	47.8	88.8	87	1.8	10	4	
	3	●	MPS1-1000S-DIN-C	31.8	46.8	47.8	88.8	87	1.8	10	2	
	5	□	MPS1-1000L-DIN	45.8	60.8	61.8	102.8	101	1.8	10	4	
	5	●	MPS1-1000L-DIN-C	45.8	60.8	61.8	102.8	101	1.8	10	2	
	2	●	MPS1-1000-PC	21.6	44.6	44.6	90.6	89	1.6	10	2	
	8	●	MPS1-1000-L8C	82.1	112.1	115.1	156.1	154	2.1	10	2	
	10	●	MPS1-1000-L10C	101.8	131.8	134.8	175.8	174	1.8	10	2	
	12	●	MPS1-1000-L12C	121.8	151.8	154.8	195.8	194	1.8	10	2	
	15	●	MPS1-1000-L15C	151.8	181.8	184.8	225.8	224	1.8	10	2	
	20	●	MPS1-1000-L20C	201.8	231.8	234.8	275.8	274	1.8	10	2	
	25	●	MPS1-1000-L25C	251.8	281.8	284.8	325.8	324	1.8	10	2	
	30	●	MPS1-1000-L30C	301.8	331.8	334.8	375.8	374	1.8	10	2	
35	□	MPS1-1000-L35C	351.8	381.8	383.8	424.8	423	1.8	10	2		
10.05	3	□	MPS1-1005S-DIN	39.8	54.8	55.8	101.8	100	1.8	12	4	
	3	●	MPS1-1005S-DIN-C	39.8	54.8	55.8	101.8	100	1.8	12	2	
	5	□	MPS1-1005L-DIN	55.8	70.8	71.8	117.8	116	1.8	12	4	
	5	●	MPS1-1005L-DIN-C	55.8	70.8	71.8	117.8	116	1.8	12	2	
	5	□	MPS1-1010S-DIN	39.7	54.8	55.8	101.8	100	1.8	12	4	
10.1	3	●	MPS1-1010S-DIN-C	39.7	54.8	55.8	101.8	100	1.8	12	2	
	5	□	MPS1-1010L-DIN	55.7	70.8	71.8	117.8	116	1.8	12	4	
	5	●	MPS1-1010L-DIN-C	55.7	70.8	71.8	117.8	116	1.8	12	2	
	2	●	MPS1-1010-PC	21.8	44.6	47.6	96.6	95	1.6	12	2	
	8	●	MPS1-1010-L8C	82.9	118.1	121.1	167.1	165	2.1	12	2	
	10	□	MPS1-1010-L10C	102.8	138.8	141.8	187.8	186	1.8	12	2	
	12	●	MPS1-1010-L12C	123.0	159.8	162.8	208.8	207	1.8	12	2	
	15	●	MPS1-1010-L15C	153.3	190.8	193.8	239.8	238	1.8	12	2	
	20	●	MPS1-1010-L20C	203.8	243.8	246.8	292.8	291	1.8	12	2	
	25	□	MPS1-1010-L25C	254.3	295.8	298.8	344.8	343	1.8	12	2	
10.2	3	□	MPS1-1020S-DIN	39.6	54.9	55.9	101.9	100	1.9	12	4	
	3	●	MPS1-1020S-DIN-C	39.6	54.9	55.9	101.9	100	1.9	12	2	
	5	□	MPS1-1020L-DIN	55.6	70.9	71.9	117.9	116	1.9	12	4	
	5	●	MPS1-1020L-DIN-C	55.6	70.9	71.9	117.9	116	1.9	12	2	
	2	●	MPS1-1020-PC	22.0	44.6	47.6	96.6	95	1.6	12	2	
	8	●	MPS1-1020-L8C	83.7	118.1	121.1	167.1	165	2.1	12	2	
	10	□	MPS1-1020-L10C	103.9	138.9	141.9	187.9	186	1.9	12	2	
	12	●	MPS1-1020-L12C	124.3	159.9	162.9	208.9	207	1.9	12	2	
	15	●	MPS1-1020-L15C	154.9	190.9	193.9	239.9	238	1.9	12	2	
	20	●	MPS1-1020-L20C	205.9	243.9	246.9	292.9	291	1.9	12	2	
	25	□	MPS1-1020-L25C	256.9	295.9	298.9	344.9	343	1.9	12	2	
	10.3	3	□	MPS1-1030S-DIN	39.4	54.9	55.9	101.9	100	1.9	12	4
3		●	MPS1-1030S-DIN-C	39.4	54.9	55.9	101.9	100	1.9	12	2	
5		□	MPS1-1030L-DIN	55.4	70.9	71.9	117.9	116	1.9	12	4	
5		●	MPS1-1030L-DIN-C	55.4	70.9	71.9	117.9	116	1.9	12	2	
2		●	MPS1-1030-PC	22.2	44.6	47.6	96.6	95	1.6	12	2	
8		●	MPS1-1030-L8C	84.5	118.1	121.1	167.1	165	2.1	12	2	
10		□	MPS1-1030-L10C	104.9	138.9	141.9	187.9	186	1.9	12	2	
12		●	MPS1-1030-L12C	125.5	159.9	162.9	208.9	207	1.9	12	2	
15		□	MPS1-1030-L15C	156.4	190.9	193.9	239.9	238	1.9	12	2	
20		□	MPS1-1030-L20C	207.9	243.9	246.9	292.9	291	1.9	12	2	
25		□	MPS1-1030-L25C	259.4	295.9	298.9	344.9	343	1.9	12	2	

DC (mm)	Głębokość otworu (L/D)	DP1021	Numer zamówieniowy	Wymiary (mm)								Typ
				LU	LCF	LH	OAL	LF	PL	DCON		
10.4	3	□	MPS1-1040S-DIN	39.3	54.9	55.9	101.9	100	1.9	12	4	
	3	●	MPS1-1040S-DIN-C	39.3	54.9	55.9	101.9	100	1.9	12	2	
	5	□	MPS1-1040L-DIN	55.3	70.9	71.9	117.9	116	1.9	12	4	
	5	●	MPS1-1040L-DIN-C	55.3	70.9	71.9	117.9	116	1.9	12	2	
	2	●	MPS1-1040-PC	22.4	44.6	47.6	96.6	95	1.6	12	2	
	8	●	MPS1-1040-L8C	85.4	118.2	121.2	167.2	165	2.2	12	2	
	10	□	MPS1-1040-L10C	105.9	138.9	141.9	187.9	186	1.9	12	2	
	12	●	MPS1-1040-L12C	126.7	159.9	162.9	208.9	207	1.9	12	2	
	15	□	MPS1-1040-L15C	157.9	190.9	193.9	239.9	238	1.9	12	2	
	20	□	MPS1-1040-L20C	209.9	243.9	246.9	292.9	291	1.9	12	2	
	25	□	MPS1-1040-L25C	261.9	295.9	298.9	344.9	343	1.9	12	2	
	10.5	3	□	MPS1-1050S-DIN	39.2	54.9	55.9	101.9	100	1.9	12	4
3		●	MPS1-1050S-DIN-C	39.2	54.9	55.9	101.9	100	1.9	12	2	
5		□	MPS1-1050L-DIN	55.2	70.9	71.9	117.9	116	1.9	12	4	
5		●	MPS1-1050L-DIN-C	55.2	70.9	71.9	117.9	116	1.9	12	2	
2		●	MPS1-1050-PC	22.7	44.7	47.7	96.7	95	1.7	12	2	
8		●	MPS1-1050-L8C	86.2	118.2	121.2	167.2	165	2.2	12	2	
10		□	MPS1-1050-L10C	106.9	138.9	141.9	187.9	186	1.9	12	2	
12		●	MPS1-1050-L12C	127.9	159.9	162.9	208.9	207	1.9	12	2	
15		●	MPS1-1050-L15C	159.4	190.9	193.9	239.9	238	1.9	12	2	
20		●	MPS1-1050-L20C	211.9	243.9	246.9	292.9	291	1.9	12	2	
25		●	MPS1-1050-L25C	264.4	295.9	298.9	344.9	343	1.9	12	2	
10.6		3	□	MPS1-1060S-DIN	39.0	54.9	55.9	101.9	100	1.9	12	4
	3	●	MPS1-1060S-DIN-C	39.0	54.9	55.9	101.9	100	1.9	12	2	
	5	□	MPS1-1060L-DIN	55.0	70.9	71.9	117.9	116	1.9	12	4	
	5	●	MPS1-1060L-DIN-C	55.0	70.9	71.9	117.9	116	1.9	12	2	
	2	□	MPS1-1060-PC	22.9	48.7	49.7	96.7	95	1.7	12	2	
	8	●	MPS1-1060-L8C	87.0	123.2	126.2	172.2	170	2.2	12	2	
	10	□	MPS1-1060-L10C	107.9	144.9	147.9	193.9	192	1.9	12	2	
	12	□	MPS1-1060-L12C	129.1	166.9	169.9	215.9	214	1.9	12	2	
	15	□	MPS1-1060-L15C	160.9	199.9	202.9	248.9	247	1.9	12	2	
	20	□	MPS1-1060-L20C	213.9	254.9	257.9	303.9	302	1.9	12	2	
	25	□	MPS1-1060-L25C	266.9	309.9	312.9	358.9	357	1.9	12	2	
	10.7	3	□	MPS1-1070S-DIN	38.9	54.9	55.9	101.9	100	1.9	12	4
3		●	MPS1-1070S-DIN-C	38.9	54.9	55.9	101.9	100	1.9	12	2	
5		□	MPS1-1070L-DIN	54.9	70.9	71.9	117.9	116	1.9	12	4	
5		●	MPS1-1070L-DIN-C	54.9	70.9	71.9	117.9	116	1.9	12	2	
2		●	MPS1-1070-PC	23.1	48.7	49.7	96.7	95	1.7	12	2	
8		●	MPS1-1070-L8C	87.8	123.2	126.2	172.2	170	2.2	12	2	
10		□	MPS1-1070-L10C	108.9	144.9	147.9	193.9	192	1.9	12	2	
12		●	MPS1-1070-L12C	130.3	166.9	169.9	215.9	214	1.9	12	2	
15		□	MPS1-1070-L15C	162.4	199.9	202.9	248.9	247	1.9	12	2	
20		□	MPS1-1070-L20C	215.9	254.9	257.9	303.9	302	1.9	12	2	
25		□	MPS1-1070-L25C	269.4	309.9	312.9	358.9	357	1.9	12	2	
10.8		3	□	MPS1-1080S-DIN	38.8	55.0	56.0	102.0	100	2.0	12	4
	3	●	MPS1-1080S-DIN-C	38.8	55.0	56.0	102.0	100	2.0	12	2	
	5	□	MPS1-1080L-DIN	54.8	71.0	72.0	118.0	116	2.0	12	4	
	5	●	MPS1-1080L-DIN-C	54.8	71.0	72.0	118.0	116	2.0	12	2	
	2	●	MPS1-1080-PC	23.3	48.7	49.7	96.7	95	1.7	12	2	
	8	●	MPS1-1080-L8C	88.6	123.2	126.2	172.2	170	2.2	12	2	
	10	□	MPS1-1080-L10C	110.0	145.0	148.0	194.0	192	2.0	12	2	
	12	●	MPS1-1080-L12C	131.6	167.0	170.0	216.0	214	2.0	12	2	
	15	□	MPS1-1080-L15C	164.0	200.0	203.0	249.0	247	2.0	12	2	
	20	□	MPS1-1080-L20C	218.0	255.0	258.0	304.0	302	2.0	12	2	
	25	□	MPS1-1080-L25C	272.0	310.0	313.0	359.0	357	2.0	12	2	

● : Standard magazynowy. □ : Niestandardowy, produkowany na specjalne zamówienie.

DC (mm)	Głębokość otworu (L/D)	DP1021	Numer zamówieniowy	Wymiary (mm)							Typ
				LU	LCF	LH	OAL	LF	PL	DCON	
10.9	3	□	MPS1-1090S-DIN	38.6	55.0	56.0	102.0	100	2.0	12	4
	3	●	MPS1-1090S-DIN-C	38.6	55.0	56.0	102.0	100	2.0	12	2
	5	□	MPS1-1090L-DIN	54.6	71.0	72.0	118.0	116	2.0	12	4
	5	●	MPS1-1090L-DIN-C	54.6	71.0	72.0	118.0	116	2.0	12	2
	2	□	MPS1-1090-PC	23.5	48.7	49.7	96.7	95	1.7	12	2
	8	●	MPS1-1090-L8C	89.5	123.3	126.3	172.3	170	2.3	12	2
	10	□	MPS1-1090-L10C	111.0	145.0	148.0	194.0	192	2.0	12	2
	12	□	MPS1-1090-L12C	132.8	167.0	170.0	216.0	214	2.0	12	2
	15	□	MPS1-1090-L15C	165.5	200.0	203.0	249.0	247	2.0	12	2
	20	□	MPS1-1090-L20C	220.0	255.0	258.0	304.0	302	2.0	12	2
25	□	MPS1-1090-L25C	274.5	310.0	313.0	359.0	357	2.0	12	2	
11.0	3	□	MPS1-1100S-DIN	38.5	55.0	56.0	102.0	100	2.0	12	4
	3	●	MPS1-1100S-DIN-C	38.5	55.0	56.0	102.0	100	2.0	12	2
	5	□	MPS1-1100L-DIN	54.5	71.0	72.0	118.0	116	2.0	12	4
	5	●	MPS1-1100L-DIN-C	54.5	71.0	72.0	118.0	116	2.0	12	2
	2	●	MPS1-1100-PC	23.7	48.7	49.7	96.7	95	1.7	12	2
	8	●	MPS1-1100-L8C	90.3	123.3	126.3	172.3	170	2.3	12	2
	10	□	MPS1-1100-L10C	112.0	145.0	148.0	194.0	192	2.0	12	2
	12	●	MPS1-1100-L12C	134.0	167.0	170.0	216.0	214	2.0	12	2
	15	●	MPS1-1100-L15C	167.0	200.0	203.0	249.0	247	2.0	12	2
	20	●	MPS1-1100-L20C	222.0	255.0	258.0	304.0	302	2.0	12	2
25	●	MPS1-1100-L25C	277.0	310.0	313.0	359.0	357	2.0	12	2	
11.1	3	□	MPS1-1110S-DIN	38.4	55.0	56.0	102.0	100	2.0	12	4
	3	●	MPS1-1110S-DIN-C	38.4	55.0	56.0	102.0	100	2.0	12	2
	5	□	MPS1-1110L-DIN	54.4	71.0	72.0	118.0	116	2.0	12	4
	5	●	MPS1-1110L-DIN-C	54.4	71.0	72.0	118.0	116	2.0	12	2
	2	●	MPS1-1110-PC	23.9	48.7	51.7	96.7	95	1.7	12	2
	8	●	MPS1-1110-L8C	91.1	129.3	132.3	178.3	176	2.3	12	2
	10	□	MPS1-1110-L10C	113.0	152.0	155.0	201.0	199	2.0	12	2
	12	●	MPS1-1110-L12C	135.2	175.0	178.0	224.0	222	2.0	12	2
	15	●	MPS1-1110-L15C	168.5	209.0	212.0	258.0	256	2.0	12	2
	20	□	MPS1-1110-L20C	224.0	267.0	270.0	316.0	314	2.0	12	2
25	●	MPS1-1110-L25C	279.5	324.0	327.0	373.0	371	2.0	12	2	
11.2	3	□	MPS1-1120S-DIN	38.2	55.0	56.0	102.0	100	2.0	12	4
	3	●	MPS1-1120S-DIN-C	38.2	55.0	56.0	102.0	100	2.0	12	2
	5	□	MPS1-1120L-DIN	54.2	71.0	72.0	118.0	116	2.0	12	4
	5	●	MPS1-1120L-DIN-C	54.2	71.0	72.0	118.0	116	2.0	12	2
	2	●	MPS1-1120-PC	24.2	48.8	51.8	96.8	95	1.8	12	2
	8	●	MPS1-1120-L8C	91.9	129.3	132.3	178.3	176	2.3	12	2
	10	□	MPS1-1120-L10C	114.0	152.0	155.0	201.0	199	2.0	12	2
	12	□	MPS1-1120-L12C	136.4	175.0	178.0	224.0	222	2.0	12	2
	15	●	MPS1-1120-L15C	170.0	209.0	212.0	258.0	256	2.0	12	2
	20	□	MPS1-1120-L20C	226.0	267.0	270.0	316.0	314	2.0	12	2
25	□	MPS1-1120-L25C	282.0	324.0	327.0	373.0	371	2.0	12	2	
11.3	3	□	MPS1-1130S-DIN	38.1	55.1	56.1	102.1	100	2.1	12	4
	3	●	MPS1-1130S-DIN-C	38.1	55.1	56.1	102.1	100	2.1	12	2
	5	□	MPS1-1130L-DIN	54.1	71.1	72.1	118.1	116	2.1	12	4
	5	●	MPS1-1130L-DIN-C	54.1	71.1	72.1	118.1	116	2.1	12	2
	2	□	MPS1-1130-PC	24.4	48.8	51.8	96.8	95	1.8	12	2
	8	●	MPS1-1130-L8C	92.7	129.3	132.3	178.3	176	2.3	12	2
	10	□	MPS1-1130-L10C	115.1	152.1	155.1	201.1	199	2.1	12	2
	12	□	MPS1-1130-L12C	137.7	175.1	178.1	224.1	222	2.1	12	2
	15	□	MPS1-1130-L15C	171.6	209.1	212.1	258.1	256	2.1	12	2
	20	□	MPS1-1130-L20C	228.1	267.1	270.1	316.1	314	2.1	12	2
25	□	MPS1-1130-L25C	284.6	324.1	327.1	373.1	371	2.1	12	2	

DC (mm)	Głębokość otworu (L/D)	DP1021	Numer zamówieniowy	Wymiary (mm)							Typ
				LU	LCF	LH	OAL	LF	PL	DCON	
11.4	3	□	MPS1-1140S-DIN	38.0	55.1	56.1	102.1	100	2.1	12	4
	3	●	MPS1-1140S-DIN-C	38.0	55.1	56.1	102.1	100	2.1	12	2
	5	□	MPS1-1140L-DIN	54.0	71.1	72.1	118.1	116	2.1	12	4
	5	●	MPS1-1140L-DIN-C	54.0	71.1	72.1	118.1	116	2.1	12	2
	2	□	MPS1-1140-PC	24.6	48.8	51.8	96.8	95	1.8	12	2
	8	●	MPS1-1140-L8C	93.6	129.4	132.4	178.4	176	2.4	12	2
	10	□	MPS1-1140-L10C	116.1	152.1	155.1	201.1	199	2.1	12	2
	12	□	MPS1-1140-L12C	138.9	175.1	178.1	224.1	222	2.1	12	2
	15	□	MPS1-1140-L15C	173.1	209.1	212.1	258.1	256	2.1	12	2
	20	□	MPS1-1140-L20C	230.1	267.1	270.1	316.1	314	2.1	12	2
25	□	MPS1-1140-L25C	287.1	324.1	327.1	373.1	371	2.1	12	2	
11.5	3	□	MPS1-1150S-DIN	37.8	55.1	56.1	102.1	100	2.1	12	4
	3	●	MPS1-1150S-DIN-C	37.8	55.1	56.1	102.1	100	2.1	12	2
	5	□	MPS1-1150L-DIN	53.8	71.1	72.1	118.1	116	2.1	12	4
	5	●	MPS1-1150L-DIN-C	53.8	71.1	72.1	118.1	116	2.1	12	2
	2	●	MPS1-1150-PC	24.8	48.8	51.8	96.8	95	1.8	12	2
	8	●	MPS1-1150-L8C	94.4	129.4	132.4	178.4	176	2.4	12	2
	10	□	MPS1-1150-L10C	117.1	152.1	155.1	201.1	199	2.1	12	2
	12	●	MPS1-1150-L12C	140.1	175.1	178.1	224.1	222	2.1	12	2
	15	●	MPS1-1150-L15C	174.6	209.1	212.1	258.1	256	2.1	12	2
	20	●	MPS1-1150-L20C	232.1	267.1	270.1	316.1	314	2.1	12	2
25	●	MPS1-1150-L25C	289.6	324.1	327.1	373.1	371	2.1	12	2	
11.6	3	□	MPS1-1160S-DIN	37.7	55.1	56.1	102.1	100	2.1	12	4
	3	●	MPS1-1160S-DIN-C	37.7	55.1	56.1	102.1	100	2.1	12	2
	5	□	MPS1-1160L-DIN	53.7	71.1	72.1	118.1	116	2.1	12	4
	5	●	MPS1-1160L-DIN-C	53.7	71.1	72.1	118.1	116	2.1	12	2
	2	□	MPS1-1160-PC	25.0	48.8	48.8	96.8	95	1.8	12	2
	8	●	MPS1-1160-L8C	95.2	134.4	137.4	183.4	181	2.4	12	2
	10	□	MPS1-1160-L10C	118.1	158.1	161.1	207.1	205	2.1	12	2
	12	□	MPS1-1160-L12C	141.3	182.1	185.1	231.1	229	2.1	12	2
	15	□	MPS1-1160-L15C	176.1	218.1	221.1	267.1	265	2.1	12	2
	20	□	MPS1-1160-L20C	234.1	278.1	281.1	327.1	325	2.1	12	2
25	□	MPS1-1160-L25C	292.1	338.1	341.1	387.1	385	2.1	12	2	
11.7	3	□	MPS1-1170S-DIN	37.6	55.1	56.1	102.1	100	2.1	12	4
	3	●	MPS1-1170S-DIN-C	37.6	55.1	56.1	102.1	100	2.1	12	2
	5	□	MPS1-1170L-DIN	53.6	71.1	72.1	118.1	116	2.1	12	4
	5	●	MPS1-1170L-DIN-C	53.6	71.1	72.1	118.1	116	2.1	12	2
	2	●	MPS1-1170-PC	25.2	48.8	48.8	96.8	95	1.8	12	2
	8	●	MPS1-1170-L8C	96.0	134.4	137.4	183.4	181	2.4	12	2
	10	□	MPS1-1170-L10C	119.1	158.1	161.1	207.1	205	2.1	12	2
	12	●	MPS1-1170-L12C	142.5	182.1	185.1	231.1	229	2.1	12	2
	15	●	MPS1-1170-L15C	177.6	218.1	221.1	267.1	265	2.1	12	2
	20	□	MPS1-1170-L20C	236.1	278.1	281.1	327.1	325	2.1	12	2
25	□	MPS1-1170-L25C	294.6	338.1	341.1	387.1	385	2.1	12	2	
11.8	3	□	MPS1-1180S-DIN	37.4	55.1	56.1	102.1	100	2.1	12	4
	3	●	MPS1-1180S-DIN-C	37.4	55.1	56.1	102.1	100	2.1	12	2
	5	□	MPS1-1180L-DIN	53.4	71.1	72.1	118.1	116	2.1	12	4
	5	●	MPS1-1180L-DIN-C	53.4	71.1	72.1	118.1	116	2.1	12	2
	2	●	MPS1-1180-PC	25.5	48.9	48.9	96.9	95	1.9	12	2
	8	●	MPS1-1180-L8C	96.8	134.4	137.4	183.4	181	2.4	12	2
	10	□	MPS1-1180-L10C	120.1	158.1	161.1	207.1	205	2.1	12	2
	12	●	MPS1-1180-L12C	143.7	182.1	185.1	231.1	229	2.1	12	2
	15	●	MPS1-1180-L15C	179.1	218.1	221.1	267.1	265	2.1	12	2
	20	□	MPS1-1180-L20C	238.1	278.1	281.1	327.1	325	2.1	12	2
25	□	MPS1-1180-L25C	297.1	338.1	341.1	387.1	385	2.1	12	2	

WIERCENIE (WIERTŁA PEŁNOWĘGLIKOWE)

MPS1

Wiertła z podwójną łysinką i wiertła super długie

WĘGLIKI
SPIEKANE

M
WIERCENIE

DC (mm)	Głębokość otworu (L/D)	DP1021	Numer zamówieniowy	Wymiary (mm)							Typ
				LU	LCF	LH	OAL	LF	PL	DCON	
11.9	3	□	MPS1-1190S-DIN	37.3	55.2	56.2	102.2	100	2.2	12	4
	3	●	MPS1-1190S-DIN-C	37.3	55.2	56.2	102.2	100	2.2	12	2
	5	□	MPS1-1190L-DIN	53.3	71.2	72.2	118.2	116	2.2	12	4
	5	●	MPS1-1190L-DIN-C	53.3	71.2	72.2	118.2	116	2.2	12	2
	2	□	MPS1-1190-PC	25.7	48.9	48.9	96.9	95	1.9	12	2
	8	●	MPS1-1190-L8C	97.7	134.5	137.5	183.5	181	2.5	12	2
	10	□	MPS1-1190-L10C	121.2	158.2	161.2	207.2	205	2.2	12	2
	12	□	MPS1-1190-L12C	145.0	182.2	185.2	231.2	229	2.2	12	2
	15	□	MPS1-1190-L15C	180.7	218.2	221.2	267.2	265	2.2	12	2
	20	□	MPS1-1190-L20C	240.2	278.2	281.2	327.2	325	2.2	12	2
25	□	MPS1-1190-L25C	299.7	338.2	341.2	387.2	385	2.2	12	2	
12.0	3	□	MPS1-1200S-DIN	37.2	55.2	56.2	102.2	100	2.2	12	4
	3	●	MPS1-1200S-DIN-C	37.2	55.2	56.2	102.2	100	2.2	12	2
	5	□	MPS1-1200L-DIN	53.2	71.2	72.2	118.2	116	2.2	12	4
	5	●	MPS1-1200L-DIN-C	53.2	71.2	72.2	118.2	116	2.2	12	2
	2	●	MPS1-1200-PC	25.9	48.9	48.9	96.9	95	1.9	12	2
	8	●	MPS1-1200-L8C	98.5	134.5	137.5	183.5	181	2.5	12	2
	10	□	MPS1-1200-L10C	122.2	158.2	161.2	207.2	205	2.2	12	2
	12	●	MPS1-1200-L12C	146.2	182.2	185.2	231.2	229	2.2	12	2
	15	●	MPS1-1200-L15C	182.2	218.2	221.2	267.2	265	2.2	12	2
	20	●	MPS1-1200-L20C	242.2	278.2	281.2	327.2	325	2.2	12	2
25	●	MPS1-1200-L25C	302.2	338.2	341.2	387.2	385	2.2	12	2	
12.05	3	□	MPS1-1205S-DIN	42.1	60.2	61.2	107.2	105	2.2	14	4
	3	●	MPS1-1205S-DIN-C	42.1	60.2	61.2	107.2	105	2.2	14	2
	5	□	MPS1-1205L-DIN	59.1	77.2	78.2	124.2	122	2.2	14	4
	5	●	MPS1-1205L-DIN-C	59.1	77.2	78.2	124.2	122	2.2	14	2
12.1	3	□	MPS1-1210S-DIN	42.1	60.2	61.2	107.2	105	2.2	14	4
	3	●	MPS1-1210S-DIN-C	42.1	60.2	61.2	107.2	105	2.2	14	2
	5	□	MPS1-1210L-DIN	59.1	77.2	78.2	124.2	122	2.2	14	4
	5	●	MPS1-1210L-DIN-C	59.1	77.2	78.2	124.2	122	2.2	14	2
	2	●	MPS1-1210-PC	26.1	52.9	55.9	103.9	102	1.9	14	2
	8	●	MPS1-1210-L8C	99.3	140.5	143.5	189.5	187	2.5	14	2
	10	□	MPS1-1210-L10C	123.2	165.2	168.2	214.2	212	2.2	14	2
	12	●	MPS1-1210-L12C	147.4	190.2	193.2	239.2	237	2.2	14	2
	15	●	MPS1-1210-L15C	183.7	227.2	230.2	276.2	274	2.2	14	2
	20	□	MPS1-1210-L20C	244.2	290.2	293.2	339.2	337	2.2	14	2
12.2	3	□	MPS1-1220S-DIN	41.9	60.2	61.2	107.2	105	2.2	14	4
	3	●	MPS1-1220S-DIN-C	41.9	60.2	61.2	107.2	105	2.2	14	2
	5	□	MPS1-1220L-DIN	58.9	77.2	78.2	124.2	122	2.2	14	4
	5	●	MPS1-1220L-DIN-C	58.9	77.2	78.2	124.2	122	2.2	14	2
	2	●	MPS1-1220-PC	26.3	52.9	55.9	103.9	102	1.9	14	2
	8	●	MPS1-1220-L8C	100.1	140.5	143.5	189.5	187	2.5	14	2
	10	□	MPS1-1220-L10C	124.2	165.2	168.2	214.2	212	2.2	14	2
	12	●	MPS1-1220-L12C	148.6	190.2	193.2	239.2	237	2.2	14	2
	15	●	MPS1-1220-L15C	185.2	227.2	230.2	276.2	274	2.2	14	2
	20	□	MPS1-1220-L20C	246.2	290.2	293.2	339.2	337	2.2	14	2
12.3	3	□	MPS1-1230S-DIN	41.8	60.2	61.2	107.2	105	2.2	14	4
	3	●	MPS1-1230S-DIN-C	41.8	60.2	61.2	107.2	105	2.2	14	2
	5	□	MPS1-1230L-DIN	58.8	77.2	78.2	124.2	122	2.2	14	4
	5	●	MPS1-1230L-DIN-C	58.8	77.2	78.2	124.2	122	2.2	14	2
	2	□	MPS1-1230-PC	26.5	52.9	55.9	103.9	102	1.9	14	2
	8	●	MPS1-1230-L8C	100.9	140.5	143.5	189.5	187	2.5	14	2
	10	□	MPS1-1230-L10C	125.2	165.2	168.2	214.2	212	2.2	14	2
	12	□	MPS1-1230-L12C	149.8	190.2	193.2	239.2	237	2.2	14	2
	15	□	MPS1-1230-L15C	186.7	227.2	230.2	276.2	274	2.2	14	2
	20	□	MPS1-1230-L20C	248.2	290.2	293.2	339.2	337	2.2	14	2

DC (mm)	Głębokość otworu (L/D)	DP1021	Numer zamówieniowy	Wymiary (mm)							Typ
				LU	LCF	LH	OAL	LF	PL	DCON	
12.4	3	□	MPS1-1240S-DIN	41.7	60.3	61.3	107.3	105	2.3	14	4
	3	●	MPS1-1240S-DIN-C	41.7	60.3	61.3	107.3	105	2.3	14	2
	5	□	MPS1-1240L-DIN	58.7	77.3	78.3	124.3	122	2.3	14	4
	5	●	MPS1-1240L-DIN-C	58.7	77.3	78.3	124.3	122	2.3	14	2
	2	□	MPS1-1240-PC	26.8	53.0	56.0	104.0	102	2.0	14	2
	8	●	MPS1-1240-L8C	101.8	140.6	143.6	189.6	187	2.6	14	2
	10	□	MPS1-1240-L10C	126.3	165.3	168.3	214.3	212	2.3	14	2
	12	□	MPS1-1240-L12C	151.1	190.3	193.3	239.3	237	2.3	14	2
	15	□	MPS1-1240-L15C	188.3	227.3	230.3	276.3	274	2.3	14	2
	20	□	MPS1-1240-L20C	250.3	290.3	293.3	339.3	337	2.3	14	2
12.5	3	□	MPS1-1250S-DIN	41.5	60.3	61.3	107.3	105	2.3	14	4
	3	●	MPS1-1250S-DIN-C	41.5	60.3	61.3	107.3	105	2.3	14	2
	5	□	MPS1-1250L-DIN	58.5	77.3	78.3	124.3	122	2.3	14	4
	5	●	MPS1-1250L-DIN-C	58.5	77.3	78.3	124.3	122	2.3	14	2
	2	●	MPS1-1250-PC	27.0	53.0	56.0	104.0	102	2.0	14	2
	8	●	MPS1-1250-L8C	102.6	140.6	143.6	189.6	187	2.6	14	2
	10	□	MPS1-1250-L10C	127.3	165.3	168.3	214.3	212	2.3	14	2
	12	●	MPS1-1250-L12C	152.3	190.3	193.3	239.3	237	2.3	14	2
	15	●	MPS1-1250-L15C	189.8	227.3	230.3	276.3	274	2.3	14	2
	20	□	MPS1-1250-L20C	252.3	290.3	293.3	339.3	337	2.3	14	2
12.6	3	□	MPS1-1260S-DIN	41.4	60.3	61.3	107.3	105	2.3	14	4
	3	●	MPS1-1260S-DIN-C	41.4	60.3	61.3	107.3	105	2.3	14	2
	5	□	MPS1-1260L-DIN	58.4	77.3	78.3	124.3	122	2.3	14	4
	5	●	MPS1-1260L-DIN-C	58.4	77.3	78.3	124.3	122	2.3	14	2
	2	□	MPS1-1260-PC	27.2	53.0	55.0	104.0	102	2.0	14	2
	8	●	MPS1-1260-L8C	103.4	145.6	148.6	194.6	192	2.6	14	2
	10	□	MPS1-1260-L10C	128.3	171.3	174.3	220.3	218	2.3	14	2
	12	□	MPS1-1260-L12C	153.5	197.3	200.3	246.3	244	2.3	14	2
	15	□	MPS1-1260-L15C	191.3	236.3	239.3	285.3	283	2.3	14	2
	20	□	MPS1-1260-L20C	254.3	301.3	304.3	350.3	348	2.3	14	2
12.7	3	□	MPS1-1270S-DIN	41.3	60.3	61.3	107.3	105	2.3	14	4
	3	●	MPS1-1270S-DIN-C	41.3	60.3	61.3	107.3	105	2.3	14	2
	5	□	MPS1-1270L-DIN	58.3	77.3	78.3	124.3	122	2.3	14	4
	5	●	MPS1-1270L-DIN-C	58.3	77.3	78.3	124.3	122	2.3	14	2
	2	□	MPS1-1270-PC	27.4	53.0	55.0	104.0	102	2.0	14	2
	8	●	MPS1-1270-L8C	104.2	145.6	148.6	194.6	192	2.6	14	2
	10	□	MPS1-1270-L10C	129.3	171.3	174.3	220.3	218	2.3	14	2
	12	●	MPS1-1270-L12C	154.7	197.3	200.3	246.3	244	2.3	14	2
	15	□	MPS1-1270-L15C	192.8	236.3	239.3	285.3	283	2.3	14	2
	20	□	MPS1-1270-L20C	256.3	301.3	304.3	350.3	348	2.3	14	2
12.8	3	□	MPS1-1280S-DIN	41.1	60.3	61.3	107.3	105	2.3	14	4
	3	●	MPS1-1280S-DIN-C	41.1	60.3	61.3	107.3	105	2.3	14	2
	5	□	MPS1-1280L-DIN	58.1	77.3	78.3	124.3	122	2.3	14	4
	5	●	MPS1-1280L-DIN-C	58.1	77.3	78.3	124.3	122	2.3	14	2
	2	●	MPS1-1280-PC	27.6	53.0	55.0	104.0	102	2.0	14	2
	8	●	MPS1-1280-L8C	105.1	145.7	148.7	194.7	192	2.7	14	2
	10	□	MPS1-1280-L10C	130.3	171.3	174.3	220.3	218	2.3	14	2
	12	●	MPS1-1280-L12C	155.9	197.3	200.3	246.3	244	2.3	14	2
	15	□	MPS1-1280-L15C	194.3	236.3	239.3	285.3	283	2.3	14	2
	20	□	MPS1-1280-L20C	258.3	301.3	304.3	350.3	348	2.3	14	2

● : Standard magazynowy. □ : Niestandardowy, produkowany na specjalne zamówienie.

DC	Głębokość otworu (mm)	DP1021 (L/D)	Numer zamówieniowy	Wymiary (mm)							Typ
				LU	LCF	LH	OAL	LF	PL	DCON	
12.9	3	□	MPS1-1290S-DIN	41.0	60.3	61.3	107.3	105	2.3	14	4
	3	●	MPS1-1290S-DIN-C	41.0	60.3	61.3	107.3	105	2.3	14	2
	5	□	MPS1-1290L-DIN	58.0	77.3	78.3	124.3	122	2.3	14	4
	5	●	MPS1-1290L-DIN-C	58.0	77.3	78.3	124.3	122	2.3	14	2
	2	□	MPS1-1290-PC	27.8	53.0	55.0	104.0	102	2.0	14	2
	8	●	MPS1-1290-L8C	105.9	145.7	148.7	194.7	192	2.7	14	2
	10	□	MPS1-1290-L10C	131.3	171.3	174.3	220.3	218	2.3	14	2
	12	□	MPS1-1290-L12C	157.1	197.3	200.3	246.3	244	2.3	14	2
	15	□	MPS1-1290-L15C	195.8	236.3	239.3	285.3	283	2.3	14	2
	20	□	MPS1-1290-L20C	260.3	301.3	304.3	350.3	348	2.3	14	2
13.0	3	□	MPS1-1300S-DIN	40.9	60.4	61.4	107.4	105	2.4	14	4
	3	●	MPS1-1300S-DIN-C	40.9	60.4	61.4	107.4	105	2.4	14	2
	5	□	MPS1-1300L-DIN	57.9	77.4	78.4	124.4	122	2.4	14	4
	5	●	MPS1-1300L-DIN-C	57.9	77.4	78.4	124.4	122	2.4	14	2
	2	●	MPS1-1300-PC	28.0	53.0	55.0	104.0	102	2.0	14	2
	8	●	MPS1-1300-L8C	106.7	145.7	148.7	194.7	192	2.7	14	2
	10	□	MPS1-1300-L10C	132.4	171.4	174.4	220.4	218	2.4	14	2
	12	●	MPS1-1300-L12C	158.4	197.4	200.4	246.4	244	2.4	14	2
	15	●	MPS1-1300-L15C	197.4	236.4	239.4	285.4	283	2.4	14	2
	20	●	MPS1-1300-L20C	262.4	301.4	304.4	350.4	348	2.4	14	2
13.1	3	□	MPS1-1310S-DIN	40.7	60.4	61.4	107.4	105	2.4	14	4
	3	●	MPS1-1310S-DIN-C	40.7	60.4	61.4	107.4	105	2.4	14	2
	5	□	MPS1-1310L-DIN	57.7	77.4	78.4	124.4	122	2.4	14	4
	5	●	MPS1-1310L-DIN-C	57.7	77.4	78.4	124.4	122	2.4	14	2
	2	□	MPS1-1310-PC	28.3	56.1	59.1	109.1	107	2.1	14	2
	8	●	MPS1-1310-L8C	107.5	151.7	154.7	200.7	198	2.7	14	2
	10	□	MPS1-1310-L10C	133.4	178.4	181.4	227.4	225	2.4	14	2
	12	□	MPS1-1310-L12C	159.6	205.4	208.4	254.4	252	2.4	14	2
	15	□	MPS1-1310-L15C	198.9	245.4	248.4	294.4	292	2.4	14	2
	20	□	MPS1-1310-L20C	264.4	313.4	316.4	362.4	360	2.4	14	2
13.2	3	□	MPS1-1320S-DIN	40.6	60.4	61.4	107.4	105	2.4	14	4
	3	●	MPS1-1320S-DIN-C	40.6	60.4	61.4	107.4	105	2.4	14	2
	5	□	MPS1-1320L-DIN	57.6	77.4	78.4	124.4	122	2.4	14	4
	5	●	MPS1-1320L-DIN-C	57.6	77.4	78.4	124.4	122	2.4	14	2
	2	●	MPS1-1320-PC	28.5	56.1	59.1	109.1	107	2.1	14	2
	8	●	MPS1-1320-L8C	108.3	151.7	154.7	200.7	198	2.7	14	2
	10	□	MPS1-1320-L10C	134.4	178.4	181.4	227.4	225	2.4	14	2
	12	●	MPS1-1320-L12C	160.8	205.4	208.4	254.4	252	2.4	14	2
	15	□	MPS1-1320-L15C	200.4	245.4	248.4	294.4	292	2.4	14	2
	20	□	MPS1-1320-L20C	266.4	313.4	316.4	362.4	360	2.4	14	2
13.3	3	□	MPS1-1330S-DIN	40.5	60.4	61.4	107.4	105	2.4	14	4
	3	●	MPS1-1330S-DIN-C	40.5	60.4	61.4	107.4	105	2.4	14	2
	5	□	MPS1-1330L-DIN	57.5	77.4	78.4	124.4	122	2.4	14	4
	5	●	MPS1-1330L-DIN-C	57.5	77.4	78.4	124.4	122	2.4	14	2
	2	□	MPS1-1330-PC	28.7	56.1	59.1	109.1	107	2.1	14	2
	8	●	MPS1-1330-L8C	109.2	151.8	154.8	200.8	198	2.8	14	2
	10	□	MPS1-1330-L10C	135.4	178.4	181.4	227.4	225	2.4	14	2
	12	□	MPS1-1330-L12C	162.0	205.4	208.4	254.4	252	2.4	14	2
	15	□	MPS1-1330-L15C	201.9	245.4	248.4	294.4	292	2.4	14	2
	20	□	MPS1-1330-L20C	268.4	313.4	316.4	362.4	360	2.4	14	2

DC	Głębokość otworu (mm)	DP1021 (L/D)	Numer zamówieniowy	Wymiary (mm)							Typ
				LU	LCF	LH	OAL	LF	PL	DCON	
13.4	3	□	MPS1-1340S-DIN	40.3	60.4	61.4	107.4	105	2.4	14	4
	3	●	MPS1-1340S-DIN-C	40.3	60.4	61.4	107.4	105	2.4	14	2
	5	□	MPS1-1340L-DIN	57.3	77.4	78.4	124.4	122	2.4	14	4
	5	●	MPS1-1340L-DIN-C	57.3	77.4	78.4	124.4	122	2.4	14	2
	2	□	MPS1-1340-PC	28.9	56.1	59.1	109.1	107	2.1	14	2
	8	●	MPS1-1340-L8C	110.0	151.8	154.8	200.8	198	2.8	14	2
	10	□	MPS1-1340-L10C	136.4	178.4	181.4	227.4	225	2.4	14	2
	12	□	MPS1-1340-L12C	163.2	205.4	208.4	254.4	252	2.4	14	2
	15	□	MPS1-1340-L15C	203.4	245.4	248.4	294.4	292	2.4	14	2
	20	□	MPS1-1340-L20C	270.4	313.4	316.4	362.4	360	2.4	14	2
13.5	3	□	MPS1-1350S-DIN	40.2	60.5	61.5	107.5	105	2.5	14	4
	3	●	MPS1-1350S-DIN-C	40.2	60.5	61.5	107.5	105	2.5	14	2
	5	□	MPS1-1350L-DIN	57.2	77.5	78.5	124.5	122	2.5	14	4
	5	●	MPS1-1350L-DIN-C	57.2	77.5	78.5	124.5	122	2.5	14	2
	2	●	MPS1-1350-PC	29.1	56.1	59.1	109.1	107	2.1	14	2
	8	●	MPS1-1350-L8C	110.8	151.8	154.8	200.8	198	2.8	14	2
	10	□	MPS1-1350-L10C	137.5	178.5	181.5	227.5	225	2.5	14	2
	12	●	MPS1-1350-L12C	164.5	205.5	208.5	254.5	252	2.5	14	2
	15	□	MPS1-1350-L15C	205.0	245.5	248.5	294.5	292	2.5	14	2
	20	□	MPS1-1350-L20C	272.5	313.5	316.5	362.5	360	2.5	14	2
13.6	3	□	MPS1-1360S-DIN	40.1	60.5	61.5	107.5	105	2.5	14	4
	3	●	MPS1-1360S-DIN-C	40.1	60.5	61.5	107.5	105	2.5	14	2
	5	□	MPS1-1360L-DIN	57.1	77.5	78.5	124.5	122	2.5	14	4
	5	●	MPS1-1360L-DIN-C	57.1	77.5	78.5	124.5	122	2.5	14	2
	2	□	MPS1-1360-PC	29.3	56.1	56.1	109.1	107	2.1	14	2
	8	●	MPS1-1360-L8C	111.6	156.8	159.8	205.8	203	2.8	14	2
	10	□	MPS1-1360-L10C	138.5	184.5	187.5	233.5	231	2.5	14	2
	12	□	MPS1-1360-L12C	165.7	212.5	215.5	261.5	259	2.5	14	2
	15	□	MPS1-1360-L15C	206.5	254.5	257.5	303.5	301	2.5	14	2
	20	□	MPS1-1360-L20C	274.5	324.5	327.5	373.5	371	2.5	14	2
13.7	3	□	MPS1-1370S-DIN	39.9	60.5	61.5	107.5	105	2.5	14	4
	3	●	MPS1-1370S-DIN-C	39.9	60.5	61.5	107.5	105	2.5	14	2
	5	□	MPS1-1370L-DIN	56.9	77.5	78.5	124.5	122	2.5	14	4
	5	●	MPS1-1370L-DIN-C	56.9	77.5	78.5	124.5	122	2.5	14	2
	2	□	MPS1-1370-PC	29.6	56.2	56.2	109.2	107	2.2	14	2
	8	●	MPS1-1370-L8C	112.4	156.8	159.8	205.8	203	2.8	14	2
	10	□	MPS1-1370-L10C	139.5	184.5	187.5	233.5	231	2.5	14	2
	12	□	MPS1-1370-L12C	166.9	212.5	215.5	261.5	259	2.5	14	2
	15	□	MPS1-1370-L15C	208.0	254.5	257.5	303.5	301	2.5	14	2
	20	□	MPS1-1370-L20C	276.5	324.5	327.5	373.5	371	2.5	14	2
13.8	3	□	MPS1-1380S-DIN	39.8	60.5	61.5	107.5	105	2.5	14	4
	3	●	MPS1-1380S-DIN-C	39.8	60.5	61.5	107.5	105	2.5	14	2
	5	□	MPS1-1380L-DIN	56.8	77.5	78.5	124.5	122	2.5	14	4
	5	●	MPS1-1380L-DIN-C	56.8	77.5	78.5	124.5	122	2.5	14	2
	2	□	MPS1-1380-PC	29.8	56.2	56.2	109.2	107	2.2	14	2
	8	●	MPS1-1380-L8C	113.3	156.9	159.9	205.9	203	2.9	14	2
	10	□	MPS1-1380-L10C	140.5	184.5	187.5	233.5	231	2.5	14	2
	12	□	MPS1-1380-L12C	168.1	212.5	215.5	261.5	259	2.5	14	2
	15	□	MPS1-1380-L15C	209.5	254.5	257.5	303.5	301	2.5	14	2
	20	□	MPS1-1380-L20C	278.5	324.5	327.5	373.5	371	2.5	14	2

WIERCENIE (WIERTŁA PEŁNOWĘGLIKOWE)

MPS1

Wiertła z podwójną łysinką
i wiertła super długie

WĘGLIKI
SPIEKANE

M
WIERCENIE

DC (mm)	Głębokość otworu (L/D)	DP1021	Numer zamówieniowy	Wymiary (mm)							Typ
				LU	LCF	LH	OAL	LF	PL	DCON	
13.9	3	□	MPS1-1390S-DIN	39.7	60.5	61.5	107.5	105	2.5	14	4
	3	●	MPS1-1390S-DIN-C	39.7	60.5	61.5	107.5	105	2.5	14	2
	5	□	MPS1-1390L-DIN	56.7	77.5	78.5	124.5	122	2.5	14	4
	5	●	MPS1-1390L-DIN-C	56.7	77.5	78.5	124.5	122	2.5	14	2
	2	□	MPS1-1390-PC	30.0	56.2	56.2	109.2	107	2.2	14	2
	8	●	MPS1-1390-L8C	114.1	156.9	159.9	205.9	203	2.9	14	2
	10	□	MPS1-1390-L10C	141.5	184.5	187.5	233.5	231	2.5	14	2
	12	□	MPS1-1390-L12C	169.3	212.5	215.5	261.5	259	2.5	14	2
	15	□	MPS1-1390-L15C	211.0	254.5	257.5	303.5	301	2.5	14	2
	20	□	MPS1-1390-L20C	280.5	324.5	327.5	373.5	371	2.5	14	2
14.0	3	□	MPS1-1400S-DIN	39.5	60.5	61.5	107.5	105	2.5	14	4
	3	●	MPS1-1400S-DIN-C	39.5	60.5	61.5	107.5	105	2.5	14	2
	5	□	MPS1-1400L-DIN	56.5	77.5	78.5	124.5	122	2.5	14	4
	5	●	MPS1-1400L-DIN-C	56.5	77.5	78.5	124.5	122	2.5	14	2
	2	□	MPS1-1400-PC	30.2	56.2	56.2	109.2	107	2.2	14	2
	8	●	MPS1-1400-L8C	114.9	156.9	159.9	205.9	203	2.9	14	2
	10	□	MPS1-1400-L10C	142.5	184.5	187.5	233.5	231	2.5	14	2
	12	●	MPS1-1400-L12C	170.5	212.5	215.5	261.5	259	2.5	14	2
	15	●	MPS1-1400-L15C	212.5	254.5	257.5	303.5	301	2.5	14	2
	20	●	MPS1-1400-L20C	282.5	324.5	327.5	373.5	371	2.5	14	2
14.2	3	□	MPS1-1420S-DIN	43.3	64.6	65.6	114.6	112	2.6	16	4
	3	●	MPS1-1420S-DIN-C	43.3	64.6	65.6	114.6	112	2.6	16	2
	5	□	MPS1-1420L-DIN	61.3	82.6	83.6	132.6	130	2.6	16	4
	5	●	MPS1-1420L-DIN-C	61.3	82.6	83.6	132.6	130	2.6	16	2
14.5	3	□	MPS1-1450S-DIN	42.9	64.6	65.6	114.6	112	2.6	16	4
	3	●	MPS1-1450S-DIN-C	42.9	64.6	65.6	114.6	112	2.6	16	2
	5	□	MPS1-1450L-DIN	60.9	82.6	83.6	132.6	130	2.6	16	4
	5	●	MPS1-1450L-DIN-C	60.9	82.6	83.6	132.6	130	2.6	16	2
15.0	3	□	MPS1-1500S-DIN	42.2	64.7	65.7	114.7	112	2.7	16	4
	3	●	MPS1-1500S-DIN-C	42.2	64.7	65.7	114.7	112	2.7	16	2
	5	□	MPS1-1500L-DIN	60.2	82.7	83.7	132.7	130	2.7	16	4
	5	●	MPS1-1500L-DIN-C	60.2	82.7	83.7	132.7	130	2.7	16	2
15.5	3	□	MPS1-1550S-DIN	41.6	64.8	65.8	114.8	112	2.8	16	4
	3	●	MPS1-1550S-DIN-C	41.6	64.8	65.8	114.8	112	2.8	16	2
	5	□	MPS1-1550L-DIN	59.6	82.8	83.8	132.8	130	2.8	16	4
	5	●	MPS1-1550L-DIN-C	59.6	82.8	83.8	132.8	130	2.8	16	2
16.0	3	□	MPS1-1600S-DIN	40.9	64.9	65.9	114.9	112	2.9	16	4
	3	●	MPS1-1600S-DIN-C	40.9	64.9	65.9	114.9	112	2.9	16	2
	5	□	MPS1-1600L-DIN	58.9	82.9	83.9	132.9	130	2.9	16	4
	5	●	MPS1-1600L-DIN-C	58.9	82.9	83.9	132.9	130	2.9	16	2
16.5	3	□	MPS1-1650S-DIN	48.3	73.0	74.0	123.0	120	3.0	18	4
	3	●	MPS1-1650S-DIN-C	48.3	73.0	74.0	123.0	120	3.0	18	2
	5	□	MPS1-1650L-DIN	68.3	93.0	94.0	143.0	140	3.0	18	4
	5	●	MPS1-1650L-DIN-C	68.3	93.0	94.0	143.0	140	3.0	18	2
17.0	3	□	MPS1-1700S-DIN	47.6	73.1	74.1	123.1	120	3.1	18	4
	3	●	MPS1-1700S-DIN-C	47.6	73.1	74.1	123.1	120	3.1	18	2
	5	□	MPS1-1700L-DIN	67.6	93.1	94.1	143.1	140	3.1	18	4
	5	●	MPS1-1700L-DIN-C	67.6	93.1	94.1	143.1	140	3.1	18	2
17.5	3	□	MPS1-1750S-DIN	46.9	73.2	74.2	123.2	120	3.2	18	4
	3	●	MPS1-1750S-DIN-C	46.9	73.2	74.2	123.2	120	3.2	18	2
	5	□	MPS1-1750L-DIN	66.9	93.2	94.2	143.2	140	3.2	18	4
	5	●	MPS1-1750L-DIN-C	66.9	93.2	94.2	143.2	140	3.2	18	2
18.0	3	□	MPS1-1800S-DIN	46.3	73.3	74.3	123.3	120	3.3	18	4
	3	●	MPS1-1800S-DIN-C	46.3	73.3	74.3	123.3	120	3.3	18	2
	5	□	MPS1-1800L-DIN	66.3	93.3	94.3	143.3	140	3.3	18	4
	5	●	MPS1-1800L-DIN-C	66.3	93.3	94.3	143.3	140	3.3	18	2

DC (mm)	Głębokość otworu (L/D)	DP1021	Numer zamówieniowy	Wymiary (mm)							Typ
				LU	LCF	LH	OAL	LF	PL	DCON	
18.5	3	□	MPS1-1850S-DIN	51.6	79.4	80.4	131.4	128	3.4	20	4
	3	●	MPS1-1850S-DIN-C	51.6	79.4	80.4	131.4	128	3.4	20	2
	5	□	MPS1-1850L-DIN	73.6	101.4	102.4	153.4	150	3.4	20	4
	5	●	MPS1-1850L-DIN-C	73.6	101.4	102.4	153.4	150	3.4	20	2
19.0	3	□	MPS1-1900S-DIN	51.0	79.5	80.5	131.5	128	3.5	20	4
	3	●	MPS1-1900S-DIN-C	51.0	79.5	80.5	131.5	128	3.5	20	2
	5	□	MPS1-1900L-DIN	73.0	101.5	102.5	153.5	150	3.5	20	4
	5	●	MPS1-1900L-DIN-C	73.0	101.5	102.5	153.5	150	3.5	20	2
19.5	3	□	MPS1-1950S-DIN	50.3	79.5	80.5	131.5	128	3.5	20	4
	3	●	MPS1-1950S-DIN-C	50.3	79.5	80.5	131.5	128	3.5	20	2
	5	□	MPS1-1950L-DIN	72.3	101.5	102.5	153.5	150	3.5	20	4
	5	●	MPS1-1950L-DIN-C	72.3	101.5	102.5	153.5	150	3.5	20	2
20.0	3	□	MPS1-2000S-DIN	49.6	79.6	80.6	131.6	128	3.6	20	4
	3	●	MPS1-2000S-DIN-C	49.6	79.6	80.6	131.6	128	3.6	20	2
	5	□	MPS1-2000L-DIN	71.6	101.6	102.6	153.6	150	3.6	20	4
	5	●	MPS1-2000L-DIN-C	71.6	101.6	102.6	153.6	150	3.6	20	2

● : Standard magazynowy. □ : Niestandardowy, produkowany na specjalne zamówienie.

ZALECANE PARAMETRY SKRAWANIA

● WIERTŁA MPS1 (3xDC – 40xDC)

DC	L x DC		P			M	K		
			Stal konstrukcyjna, Stal węglowa, Stal stopowa			Stal nierdzewna	Żeliwo		
			≤ 180 HB	180–250 HB	280–350 HB		≤ 350 MPa	≤ 450 MPa	≤ 800 MPa
3	3–8	Vc m/min	100 (60–150)	90 (60–140)	80 (50–110)	40 (20–50)	90 (60–100)	80 (50–90)	60 (40–80)
		f mm/obr.	0.15 (0.1–0.2)	0.15 (0.1–0.19)	0.12 (0.1–0.14)	0.08 (0.06–0.12)	0.15 (0.1–0.2)	0.12 (0.08–0.16)	0.09 (0.06–0.12)
	10–25	Vc m/min	90 (40–110)	90 (40–110)	80 (40–90)	40 (20–60)	90 (40–110)	90 (40–110)	—
		f mm/obr.	0.17 (0.1–0.24)	0.17 (0.1–0.24)	0.15 (0.09–0.22)	0.07 (0.05–0.09)	0.19 (0.11–0.26)	0.17 (0.1–0.24)	—
	30–40	Vc m/min	75 (40–95)	75 (40–85)	65 (40–75)	30 (20–50)	75 (45–95)	30 (20–50)	—
		f mm/obr.	0.14 (0.08–0.19)	0.14 (0.08–0.19)	0.15 (0.07–0.18)	0.06 (0.04–0.07)	0.15 (0.09–0.21)	0.14 (0.08–0.19)	—
4	3–8	Vc m/min	120 (70–170)	100 (70–160)	90 (60–120)	40 (30–50)	100 (70–110)	90 (60–100)	70 (50–90)
		f mm/obr.	0.19 (0.12–0.25)	0.18 (0.12–0.24)	0.15 (0.12–0.18)	0.09 (0.07–0.13)	0.21 (0.12–0.3)	0.17 (0.1–0.24)	0.13 (0.08–0.18)
	10–25	Vc m/min	90 (40–110)	90 (40–110)	80 (40–90)	40 (20–60)	90 (40–110)	90 (40–110)	—
		f mm/obr.	0.2 (0.12–0.3)	0.2 (0.12–0.3)	0.18 (0.11–0.27)	0.08 (0.06–0.1)	0.22(0.13–0.33)	0.2 (0.12–0.3)	—
	30–40	Vc m/min	75 (40–95)	75 (40–85)	65 (40–75)	30 (20–50)	75 (45–95)	30 (20–50)	—
		f mm/obr.	0.16 (0.1–0.24)	0.16 (0.1–0.24)	0.18 (0.09–0.22)	0.06 (0.05–0.08)	0.18 (0.1–0.26)	0.16 (0.1–0.24)	—
5	3–8	Vc m/min	130 (80–190)	110 (80–180)	90 (70–140)	40 (30–50)	110 (80–130)	90 (70–120)	70 (60–100)
		f mm/obr.	0.23 (0.15–0.3)	0.22 (0.15–0.29)	0.19 (0.15–0.22)	0.11 (0.08–0.16)	0.25 (0.15–0.35)	0.21 (0.14–0.28)	0.17 (0.12–0.22)
	10–25	Vc m/min	90 (40–110)	90 (40–110)	80 (40–90)	40 (20–60)	90 (40–110)	90 (40–110)	—
		f mm/obr.	0.25 (0.15–0.35)	0.25 (0.15–0.35)	0.22 (0.14–0.32)	0.1 (0.07–0.12)	0.28 (0.17–0.39)	0.25 (0.15–0.35)	—
	30–40	Vc m/min	75 (40–95)	75 (40–85)	65 (40–75)	30 (20–50)	75 (45–95)	30 (20–50)	—
		f mm/obr.	0.2 (0.12–0.28)	0.2 (0.12–0.28)	0.22 (0.11–0.26)	0.08 (0.06–0.1)	0.22 (0.13–0.31)	0.2 (0.12–0.28)	—
6	3–8	Vc m/min	140 (90–210)	120 (90–190)	100 (80–150)	50 (40–70)	120 (90–140)	100 (80–130)	80 (70–110)
		f mm/obr.	0.27 (0.18–0.35)	0.26 (0.18–0.33)	0.22 (0.18–0.25)	0.14 (0.11–0.18)	0.29 (0.18–0.4)	0.25 (0.16–0.34)	0.2 (0.14–0.26)
	10–25	Vc m/min	110 (70–120)	100 (60–110)	90 (40–110)	50 (20–60)	100 (60–110)	100 (60–110)	—
		f mm/obr.	0.27 (0.17–0.37)	0.24 (0.15–0.33)	0.24 (0.15–0.33)	0.12 (0.08–0.16)	0.3 (0.19–0.41)	0.27 (0.17–0.37)	—
	30–40	Vc m/min	90 (40–110)	80 (40–90)	75 (40–85)	40 (20–60)	90 (60–110)	40 (30–60)	—
		f mm/obr.	0.22 (0.14–0.3)	0.22 (0.14–0.3)	0.24 (0.12–0.26)	0.1 (0.06–0.13)	0.24 (0.15–0.33)	0.22 (0.14–0.3)	—
8	3–8	Vc m/min	160 (100–240)	140 (100–220)	120 (90–170)	50 (40–70)	140 (100–160)	120 (90–150)	100 (80–130)
		f mm/obr.	0.3 (0.2–0.4)	0.29 (0.2–0.38)	0.24 (0.2–0.27)	0.15 (0.12–0.2)	0.33 (0.2–0.45)	0.28 (0.18–0.38)	0.23 (0.16–0.3)
	10–25	Vc m/min	110 (70–120)	100 (60–110)	90 (40–110)	50 (20–60)	100 (60–110)	100 (60–110)	—
		f mm/obr.	0.3 (0.2–0.4)	0.3 (0.2–0.4)	0.27 (0.18–0.36)	0.14 (0.1–0.17)	0.33 (0.22–0.44)	0.3 (0.2–0.4)	—
	30–40	Vc m/min	90 (40–110)	80 (40–90)	75 (40–85)	40 (20–50)	90 (60–100)	40 (30–60)	—
		f mm/obr.	0.24 (0.16–0.32)	0.24 (0.16–0.32)	0.27 (0.14–0.29)	0.11 (0.08–0.14)	0.26 (0.18–0.35)	0.24 (0.16–0.32)	—
10	3–8	Vc m/min	170 (100–250)	150 (100–230)	130 (90–180)	50 (40–70)	150 (100–170)	130 (90–160)	110 (80–140)
		f mm/obr.	0.33 (0.2–0.45)	0.32 (0.2–0.43)	0.25 (0.2–0.3)	0.16 (0.12–0.22)	0.35 (0.2–0.5)	0.29 (0.18–0.4)	0.24 (0.16–0.32)
	10–25	Vc m/min	110 (70–120)	100 (60–110)	90 (40–110)	50 (20–60)	100 (60–110)	100 (60–110)	—
		f mm/obr.	0.32 (0.22–0.42)	0.32 (0.22–0.42)	0.29 (0.2–0.38)	0.15 (0.12–0.18)	0.35 (0.24–0.46)	0.32 (0.22–0.42)	—
	30–40	Vc m/min	90 (40–110)	80 (40–90)	75 (40–95)	40 (20–50)	90 (60–100)	40 (30–60)	—
		f mm/obr.	0.26 (0.18–0.34)	0.26 (0.18–0.34)	0.29 (0.16–0.3)	0.12 (0.1–0.14)	0.28 (0.19–0.37)	0.26 (0.18–0.34)	—
12	3–8	Vc m/min	180 (100–250)	160 (100–230)	140 (90–180)	50 (40–70)	160 (100–170)	140 (90–160)	110 (80–140)
		f mm/obr.	0.35 (0.2–0.5)	0.34 (0.2–0.48)	0.27 (0.2–0.34)	0.18 (0.14–0.24)	0.4 (0.2–0.6)	0.31 (0.18–0.44)	0.25 (0.16–0.34)
	10–25	Vc m/min	130 (90–150)	120 (80–140)	100 (60–110)	60 (25–65)	120 (90–140)	120 (90–140)	—
		f mm/obr.	0.34 (0.24–0.44)	0.34 (0.24–0.44)	0.3 (0.22–0.4)	0.17 (0.14–0.19)	0.37 (0.26–0.48)	0.34 (0.24–0.44)	—
	30–40	Vc m/min	105 (55–125)	95 (55–105)	80 (40–100)	50 (20–60)	105 (65–115)	50 (40–70)	—
		f mm/obr.	0.27 (0.19–0.35)	0.27 (0.19–0.35)	0.3 (0.18–0.32)	0.14 (0.11–0.15)	0.3 (0.21–0.38)	0.27 (0.19–0.35)	—
16	3–8	Vc m/min	180 (100–250)	160 (100–230)	140 (90–180)	50 (40–70)	160 (100–170)	140 (90–160)	110 (80–140)
		f mm/obr.	0.38 (0.2–0.55)	0.36 (0.2–0.52)	0.28 (0.2–0.36)	0.19 (0.15–0.26)	0.43 (0.2–0.65)	0.33 (0.18–0.48)	0.27 (0.16–0.38)
	10–25	Vc m/min	130 (90–150)	120 (80–140)	100 (60–110)	60 (25–65)	120 (90–140)	120 (90–140)	—
		f mm/obr.	0.36 (0.26–0.46)	0.36 (0.26–0.46)	0.32 (0.23–0.41)	0.17 (0.14–0.19)	0.4 (0.29–0.48)	0.36 (0.26–0.46)	—
20	3–8	Vc m/min	180 (100–250)	160 (100–230)	140 (90–180)	50 (40–70)	160 (100–170)	140 (90–160)	110 (80–140)
		f mm/obr.	0.4 (0.2–0.6)	0.39 (0.2–0.57)	0.3 (0.2–0.4)	0.21 (0.16–0.28)	0.45 (0.2–0.7)	0.35 (0.18–0.52)	0.28 (0.16–0.4)

M

WIERCENIE

WIERCENIE (WIERTŁA PEŁNOWĘGLIKOWE)

MPS1

Wiertła z podwójną łysinką i wiertła super długie

WĘGLIKI
SPIEKANE

M

WIERCENIE

WSKAZÓWKI EKSPLOATACYJNE DLA WIERTŁ DŁUGICH TYPU MPS1

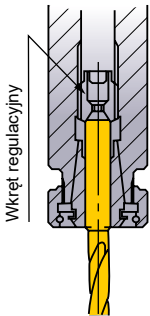
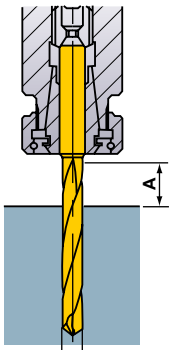
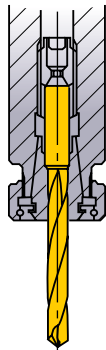
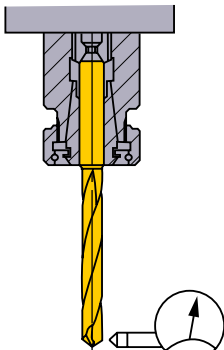
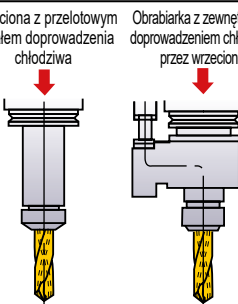
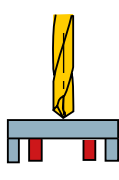
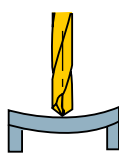
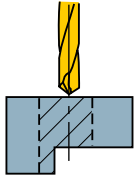
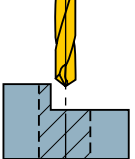
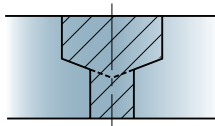
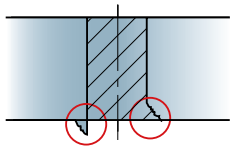
<p>Zamocowanie wiertła</p>  <p>Uchwyt z tuleją wciągającą i łożyskiem oporowym silnie mocuje narzędzie.</p>	<p>Długość wiertła</p>  <p>$A \geq DC \times 1.5$</p>	<p>Montaż wiertła</p>  <p>Nie mocować wiertła za rowek wiórowy.</p>	<p>Tolerancja montażu</p>  <p>Bicie $\leq 0.03\text{mm}$</p>
<p>Typ z przelotowym kanałem doprowadzenia chłodziwa</p>  <p>Wrzeczona z przelotowym kanałem doprowadzenia chłodziwa</p> <p>Obrabianka z zewnętrznym doprowadzeniem chłodziwa przez wrzeczono</p> <p>Ciśnienie chłodziwa wynosi ok. 5–10 bar ($< \phi 5:2-30$ bar).</p>	<p>Postępowanie z chłodziwem</p> <ol style="list-style-type: none"> 1) W wiertłach o małej średnicy drobny wiór zatyka kanał doprowadzenia chłodziwa. Profilaktycznie zawsze należy używać dokładnego filtra. 2) Cząstki brudu i kurzu w używanym chłodziwie przylegają do kanału doprowadzenia chłodziwa i uniemożliwiają skuteczny przepływ. Zalecana jest regularna wymiana chłodziwa. 	<p>Cienkie przedmioty obrabiane</p>  <p>OK</p> <p>Umieścić przedmiot obrabiany na podpórcie</p>  <p>X</p> <p>W razie wystąpienia zginania</p>	<p>Obróbka przerywana</p>  <p>OK</p> <p>Proces jednozabiegowy</p> <p>① Podczas wiercenia detalu stopniowanego zmniejszyć posuw.</p>  <p>Wymaga wstępnego wiercenia</p> <p>① Przed wierceniem wykonać splaszczanie frezem trzpieniowym</p>
<p>Otwory stopniowane</p>  <ol style="list-style-type: none"> ① Podzielić proces obróbki na dwa zabiegi. ② Najpierw wywiercić otwór o większej średnicy. <p>*Na specjalne zamówienie może być wykonane narzędzie do obróbki fazki i nawiercania.</p>	<p>Stępienie ostrych krawędzi i fazowanie przedmiotu obrabianego</p>  <ol style="list-style-type: none"> ① Pod koniec obróbki otworów przelotowych zmniejszyć posuw o 50%. ② Wykonać dodatkowo 45°fazkę. ③ Zmienić kąt wierzchołkowy. 		

WIERCENIE ZA POMOCĄ WIERTEŁ DŁUGICH

WIERCENIE PRZEDMIOTÓW O PŁASKIEJ POWIERZCHNI CZOŁOWEJ ● Wiercenie otworu nieprzelotowego

1. Wiercenie otworu pilotowego

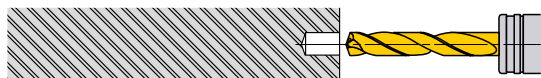

- ① Użyć wiertła o większym kącie wierzchołkowym (bardziej płaskiego), niż dla wiertła super długiego. Użyć wiertła o możliwie najkrótszym rowku wiórowym.
- ② Zapewnić wykonanie wysokodokładnego otworu pilotowego, aby proces wiercenia głębokich otworów przebiegał bez problemów
- ③ Głębokość wiercenia otworu pilotowego: ok. 1DC albo większa. (Głębokość otworu pilotowego dostosować do długości wiertła.)

2. Wiercenie wstępne wiertłem długim



- ① Wiercić wstępnie otwór pilotowy przy małych obrotach. (Obroty 1000min^{-1} , posuw $0.2-0.3\text{mm/obr}$)
- ② Zakończyć wiercenie wiertłem do głębokich otworów na $0.5-1\text{mm}$ przed dnem otworu pilotowego.

3. Wiercenie głębokiego otworu

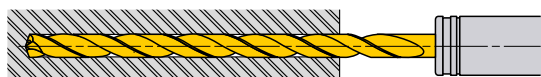

- ① Zwiększyć obroty i posuw w jednym cyklu i wiercić, aż do uzyskania żądanej głębokości otworu.

4. Wycofanie wiertła



- ① Po wierceniu zmniejszyć obroty na $0.5-1\text{mm}$ przed końcem otworu. (Obroty około 1000min^{-1})
- ② Wycofać wiertło na głębokość początkową otworu pilotowego przy prędkości posuwu 3000mm/min .
- ③ Wycofać wiertło z otworu pilotowego przy obrotach ($n=300$, $V_f=3000\text{mm/min}$.)

WIERCENIE PRZERYWANE ● Wiercenie otworów w płaszczyznach nieregularnych lub pod kątem

1. Frezowanie pogłębienia prostopadłego do kierunku wiercenia



- ① Obrabiać płaską lub nieregularną powierzchnię frezem palcowym lub frezem do rowków wpustowych o tej samej średnicy, jak wymagana średnica otworu.

2. Wiercenie otworu pilotowego



- ① Użyć wiertła o większym kącie wierzchołkowym (bardziej płaskiego), niż dla wiertła super długiego. Użyć wiertła o możliwie najkrótszym rowku wiórowym.
- ② Zapewnić wykonanie wysokodokładnego otworu pilotowego, aby proces wiercenia głębokich otworów przebiegał bez problemów
- ③ Głębokość wiercenia otworu pilotowego: ok. 1DC albo większa. (Głębokość otworu pilotowego dostosować do długości wiertła.)

3. Wiercenie wstępne wiertłem długim



- ① Wprowadzić wiertło w otwór pilotowy przy małych obrotach (prędkość skrawania $20-30\text{m/min}$, posuw $0.2-0.3\text{mm/obr}$).
- ② Zatrzymać wiertło $1\text{mm}-3\text{mm}$ przed dnem otworu pilotowego.

4. Wiercenie głębokiego otworu

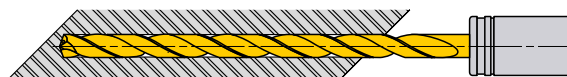

- ① Zwiększyć obroty i posuw w jednym cyklu i wiercić, aż do uzyskania żądanej głębokości otworu.

5. Wyjście z materiału

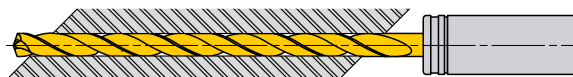

- ① Podczas wychodzenia z materiału istnieje niebezpieczeństwo uszkodzenia krawędzi skrawającej wiertła.
- ② W momencie wyjścia z materiału zmniejszyć posuw.

6. Wycofanie wiertła



- ① Wycofać wiertło do punktu początkowego otworu pilotowego przy prędkości posuwu 3000mm/min .

WIERCENIE (WIERTŁA PEŁNOWĘGLIKOWE)

MPS

Wiertła z podwójną łysinką i wiertła super długie

- Głębokość otworu: 3-40 L/D.
- MPS to typ wiertła z podwójną łysinką, co umożliwia dokładną obróbkę.



WĘGLIKI SPIEKANE

P	M	K	N	S	H
---	---	---	---	---	---

Chłodzenie wewnętrzne

	3 ≤ D1 ≤ 6	6 < D1 ≤ 10	10 < D1 ≤ 18	18 < D1 ≤ 20
Typ DIN	+0.010 -0.002	+0.010 -0.005	+0.005 -0.013	+0.005 -0.016
Inne	0 -0.012	0 -0.015	0 -0.018	0 -0.021
h6	0 -0.008	0 -0.009	0 -0.011	0 -0.013



M

WIERCENIE



● Typ 1 Typ z chwytem walcowym ze stożkową szyjką

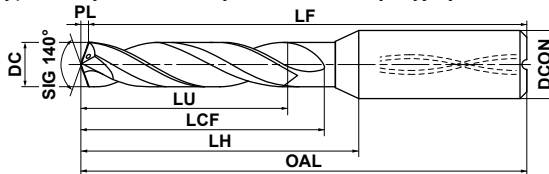

● Typ 2 Typ z chwytem walcowym

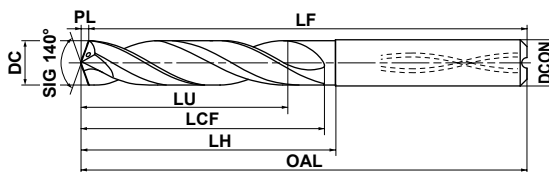

DC (mm)	Głębokość otworu (L/D)	VP15TF	Numer zamówieniowy	Wymiary (mm)							Typ	
				LU	LCF	LH	OAL	LF	PL	DCON		
3.0	3	<input type="checkbox"/>	MPS0300S-DIN-C	15.0	19.5	24.5	61.5	61	0.5	6	1	
	5	<input type="checkbox"/>	MPS0300L-DIN-C	23.0	27.5	28.5	65.5	65	0.5	6	1	
	8	<input type="checkbox"/>	MPS0300-L8C	24.5	33.5	36.5	73.5	73	0.5	6	1	
	10	<input type="checkbox"/>	MPS0300-L10C	30.5	39.5	42.5	79.5	79	0.5	6	1	
	12	<input type="checkbox"/>	MPS0300-L12C	36.5	45.5	48.5	85.5	85	0.5	6	1	
	15	<input type="checkbox"/>	MPS0300-L15C	45.5	54.5	57.5	94.5	94	0.5	6	1	
	20	<input type="checkbox"/>	MPS0300-L20C	60.5	69.5	72.5	109.5	109	0.5	6	1	
	25	<input type="checkbox"/>	MPS0300-L25C	75.5	84.5	87.5	124.5	124	0.5	6	1	
	30	<input type="checkbox"/>	MPS0300-L30C	90.5	99.5	102.5	139.5	139	0.5	6	1	
3.05	3	<input type="checkbox"/>	MPS0305S-DIN-C	15.0	19.6	24.6	61.6	61	0.6	6	1	
	5	<input type="checkbox"/>	MPS0305L-DIN-C	23.0	27.6	28.6	65.6	65	0.6	6	1	
	3.1	3	<input type="checkbox"/>	MPS0310S-DIN-C	14.9	19.6	24.6	61.6	61	0.6	6	1
		5	<input type="checkbox"/>	MPS0310L-DIN-C	22.9	27.6	28.6	65.6	65	0.6	6	1
		8	<input type="checkbox"/>	MPS0310-L8C	25.4	39.6	42.6	79.6	79	0.6	6	1
10		<input type="checkbox"/>	MPS0310-L10C	31.6	46.6	49.6	86.6	86	0.6	6	1	
12		<input type="checkbox"/>	MPS0310-L12C	37.8	53.6	56.6	93.6	93	0.6	6	1	
15		<input type="checkbox"/>	MPS0310-L15C	47.1	63.6	66.6	103.6	103	0.6	6	1	
20		<input type="checkbox"/>	MPS0310-L20C	62.6	81.6	84.6	121.6	121	0.6	6	1	
3.2	25	<input type="checkbox"/>	MPS0310-L25C	78.1	98.6	101.6	138.6	138	0.6	6	1	
	30	<input type="checkbox"/>	MPS0310-L30C	93.6	116.6	119.6	156.6	156	0.6	6	1	
	35	<input type="checkbox"/>	MPS0310-L35C	109.1	125.6	138.6	175.6	175	0.6	6	1	
	40	<input type="checkbox"/>	MPS0310-L40C	124.6	140.6	153.6	190.6	190	0.6	6	1	
	3.2	3	<input type="checkbox"/>	MPS0320S-DIN-C	14.8	19.6	24.6	61.6	61	0.6	6	1
		5	<input type="checkbox"/>	MPS0320L-DIN-C	22.8	27.6	28.6	65.6	65	0.6	6	1
		8	<input type="checkbox"/>	MPS0320-L8C	26.2	39.6	42.6	79.6	79	0.6	6	1
10		<input type="checkbox"/>	MPS0320-L10C	32.6	46.6	49.6	86.6	86	0.6	6	1	
12		<input type="checkbox"/>	MPS0320-L12C	39.0	53.6	56.6	93.6	93	0.6	6	1	
15		<input type="checkbox"/>	MPS0320-L15C	48.6	63.6	66.6	103.6	103	0.6	6	1	
20		<input type="checkbox"/>	MPS0320-L20C	64.6	81.6	84.6	121.6	121	0.6	6	1	
25		<input type="checkbox"/>	MPS0320-L25C	80.6	98.6	101.6	138.6	138	0.6	6	1	
30		<input type="checkbox"/>	MPS0320-L30C	96.6	116.6	119.6	156.6	156	0.6	6	1	
35		<input type="checkbox"/>	MPS0320-L35C	112.6	125.6	138.6	175.6	175	0.6	6	1	
40		<input type="checkbox"/>	MPS0320-L40C	128.6	140.6	153.6	190.6	190	0.6	6	1	

DC (mm)	Głębokość otworu (L/D)	VP15TF	Numer zamówieniowy	Wymiary (mm)							Typ
				LU	LCF	LH	OAL	LF	PL	DCON	
3.3	3	<input type="checkbox"/>	MPS0330S-DIN-C	14.7	19.6	24.6	61.6	61	0.6	6	1
	5	<input type="checkbox"/>	MPS0330L-DIN-C	22.7	27.6	28.6	65.6	65	0.6	6	1
	8	<input type="checkbox"/>	MPS0330-L8C	27.0	39.6	42.6	79.6	79	0.6	6	1
	10	<input type="checkbox"/>	MPS0330-L10C	33.6	46.6	49.6	86.6	86	0.6	6	1
	12	<input type="checkbox"/>	MPS0330-L12C	40.2	53.6	56.6	93.6	93	0.6	6	1
	15	<input type="checkbox"/>	MPS0330-L15C	50.1	63.6	66.6	103.6	103	0.6	6	1
	20	<input type="checkbox"/>	MPS0330-L20C	66.6	81.6	84.6	121.6	121	0.6	6	1
	25	<input type="checkbox"/>	MPS0330-L25C	83.1	98.6	101.6	138.6	138	0.6	6	1
	30	<input type="checkbox"/>	MPS0330-L30C	99.6	116.6	119.6	156.6	156	0.6	6	1
3.4	3	<input type="checkbox"/>	MPS0340S-DIN-C	14.5	19.6	24.6	61.6	61	0.6	6	1
	5	<input type="checkbox"/>	MPS0340L-DIN-C	22.5	27.6	28.6	65.6	65	0.6	6	1
	8	<input type="checkbox"/>	MPS0340-L8C	27.8	39.6	42.6	79.6	79	0.6	6	1
	10	<input type="checkbox"/>	MPS0340-L10C	34.6	46.6	49.6	86.6	86	0.6	6	1
	12	<input type="checkbox"/>	MPS0340-L12C	41.4	53.6	56.6	93.6	93	0.6	6	1
	15	<input type="checkbox"/>	MPS0340-L15C	51.6	63.6	66.6	103.6	103	0.6	6	1
	20	<input type="checkbox"/>	MPS0340-L20C	68.6	81.6	84.6	121.6	121	0.6	6	1
	25	<input type="checkbox"/>	MPS0340-L25C	85.6	98.6	101.6	138.6	138	0.6	6	1
3.5	3	<input type="checkbox"/>	MPS0350S-DIN-C	14.4	19.6	24.6	61.6	61	0.6	6	1
	5	<input type="checkbox"/>	MPS0350L-DIN-C	22.4	27.6	28.6	65.6	65	0.6	6	1
	8	<input type="checkbox"/>	MPS0350-L8C	28.6	39.6	42.6	79.6	79	0.6	6	1
	10	<input type="checkbox"/>	MPS0350-L10C	35.6	46.6	49.6	86.6	86	0.6	6	1
	12	<input type="checkbox"/>	MPS0350-L12C	42.6	53.6	56.6	93.6	93	0.6	6	1
	15	<input type="checkbox"/>	MPS0350-L15C	53.1	63.6	66.6	103.6	103	0.6	6	1
	20	<input type="checkbox"/>	MPS0350-L20C	70.6	81.6	84.6	121.6	121	0.6	6	1
	25	<input type="checkbox"/>	MPS0350-L25C	88.1	98.6	101.6	138.6	138	0.6	6	1
3.5	30	<input type="checkbox"/>	MPS0350-L30C	105.6	116.6	119.6	156.6	156	0.6	6	1
	35	<input type="checkbox"/>	MPS0350-L35C	123.1	134.6	138.6	175.6	175	0.6	6	1
	40	<input type="checkbox"/>	MPS0350-L40C	140.6	150.6	153.6	190.6	190	0.6	6	1



Prosimy o natychmiastową zmianę wszystkich nadchodzących zamówień, obejmujących pozycje zaznaczone na szaro (MPS, MSL) na serię MPS1. Produkcja serii MPS i MSL jest wygaszana i od marca 2023 zostanie całkowicie zakończona.

: Niestandardowy, produkowany na specjalne zamówienie.

DC (mm)	Głębokość otworu (L/D)	VP15TF	Numer zamówieniowy	Wymiary (mm)							Typ
				LU	LCF	LH	OAL	LF	PL	DCON	
3.6	3	<input type="checkbox"/>	MPS0360S-DIN-C	14.3	19.7	24.7	61.7	61	0.7	6	1
	5	<input type="checkbox"/>	MPS0360L-DIN-C	22.3	27.7	28.7	65.7	65	0.7	6	1
	8	<input type="checkbox"/>	MPS0360-L8C	29.5	44.7	47.7	84.7	84	0.7	6	1
	10	<input type="checkbox"/>	MPS0360-L10C	36.7	52.7	55.7	92.7	92	0.7	6	1
	12	<input type="checkbox"/>	MPS0360-L12C	43.9	60.7	63.7	100.7	100	0.7	6	1
	15	<input type="checkbox"/>	MPS0360-L15C	54.7	72.7	75.7	112.7	112	0.7	6	1
	20	<input type="checkbox"/>	MPS0360-L20C	72.7	92.7	95.7	132.7	132	0.7	6	1
	25	<input type="checkbox"/>	MPS0360-L25C	90.7	112.7	115.7	152.7	152	0.7	6	1
	30	<input type="checkbox"/>	MPS0360-L30C	108.7	132.7	135.7	172.7	172	0.7	6	1
	35	<input type="checkbox"/>	MPS0360-L35C	126.7	145.7	155.7	192.7	192	0.7	6	1
40	<input type="checkbox"/>	MPS0360-L40C	144.7	162.7	175.7	212.7	212	0.7	6	1	
3.7	3	<input type="checkbox"/>	MPS0370S-DIN-C	14.1	19.7	24.7	61.7	61	0.7	6	1
	5	<input type="checkbox"/>	MPS0370L-DIN-C	22.1	27.7	28.7	65.7	65	0.7	6	1
	8	<input type="checkbox"/>	MPS0370-L8C	30.3	44.7	47.7	84.7	84	0.7	6	1
	10	<input type="checkbox"/>	MPS0370-L10C	37.7	52.7	55.7	92.7	92	0.7	6	1
	12	<input type="checkbox"/>	MPS0370-L12C	45.1	60.7	63.7	100.7	100	0.7	6	1
	15	<input type="checkbox"/>	MPS0370-L15C	56.2	72.7	75.7	112.7	112	0.7	6	1
	20	<input type="checkbox"/>	MPS0370-L20C	74.7	92.7	95.7	132.7	132	0.7	6	1
	25	<input type="checkbox"/>	MPS0370-L25C	93.2	112.7	115.7	152.7	152	0.7	6	1
	30	<input type="checkbox"/>	MPS0370-L30C	111.7	132.7	135.7	172.7	172	0.7	6	1
	35	<input type="checkbox"/>	MPS0370-L35C	130.2	145.7	155.7	192.7	192	0.7	6	1
40	<input type="checkbox"/>	MPS0370-L40C	148.7	162.7	175.7	212.7	212	0.7	6	1	
3.8	3	<input type="checkbox"/>	MPS0380S-DIN-C	18.0	23.7	28.7	65.7	65	0.7	6	1
	5	<input type="checkbox"/>	MPS0380L-DIN-C	30.0	35.7	36.7	73.7	73	0.7	6	1
	8	<input type="checkbox"/>	MPS0380-L8C	31.1	44.7	47.7	84.7	84	0.7	6	1
	10	<input type="checkbox"/>	MPS0380-L10C	38.7	52.7	55.7	92.7	92	0.7	6	1
	12	<input type="checkbox"/>	MPS0380-L12C	46.3	60.7	63.7	100.7	100	0.7	6	1
	15	<input type="checkbox"/>	MPS0380-L15C	57.7	72.7	75.7	112.7	112	0.7	6	1
	20	<input type="checkbox"/>	MPS0380-L20C	76.7	92.7	95.7	132.7	132	0.7	6	1
	25	<input type="checkbox"/>	MPS0380-L25C	95.7	112.7	115.7	152.7	152	0.7	6	1
	30	<input type="checkbox"/>	MPS0380-L30C	114.7	132.7	135.7	172.7	172	0.7	6	1
	35	<input type="checkbox"/>	MPS0380-L35C	133.7	152.7	155.7	192.7	192	0.7	6	1
40	<input type="checkbox"/>	MPS0380-L40C	152.7	172.7	175.7	212.7	212	0.7	6	1	
3.9	3	<input type="checkbox"/>	MPS0390S-DIN-C	17.9	23.7	28.7	65.7	65	0.7	6	1
	5	<input type="checkbox"/>	MPS0390L-DIN-C	29.9	35.7	36.7	73.7	73	0.7	6	1
	8	<input type="checkbox"/>	MPS0390-L8C	31.9	44.7	47.7	84.7	84	0.7	6	1
	10	<input type="checkbox"/>	MPS0390-L10C	39.7	52.7	55.7	92.7	92	0.7	6	1
	12	<input type="checkbox"/>	MPS0390-L12C	47.5	60.7	63.7	100.7	100	0.7	6	1
	15	<input type="checkbox"/>	MPS0390-L15C	59.2	72.7	75.7	112.7	112	0.7	6	1
	20	<input type="checkbox"/>	MPS0390-L20C	78.7	92.7	95.7	132.7	132	0.7	6	1
	25	<input type="checkbox"/>	MPS0390-L25C	98.2	112.7	115.7	152.7	152	0.7	6	1
	30	<input type="checkbox"/>	MPS0390-L30C	117.7	132.7	135.7	172.7	172	0.7	6	1
	35	<input type="checkbox"/>	MPS0390-L35C	137.2	152.7	155.7	192.7	192	0.7	6	1
40	<input type="checkbox"/>	MPS0390-L40C	156.7	172.7	175.7	212.7	212	0.7	6	1	
4.0	3	<input type="checkbox"/>	MPS0400S-DIN-C	17.7	23.7	28.7	65.7	65	0.7	6	1
	5	<input type="checkbox"/>	MPS0400L-DIN-C	29.7	35.7	36.7	73.7	73	0.7	6	1
	8	<input type="checkbox"/>	MPS0400-L8C	32.7	44.7	47.7	84.7	84	0.7	6	1
	10	<input type="checkbox"/>	MPS0400-L10C	40.7	52.7	55.7	92.7	92	0.7	6	1
	12	<input type="checkbox"/>	MPS0400-L12C	48.7	60.7	63.7	100.7	100	0.7	6	1
	15	<input type="checkbox"/>	MPS0400-L15C	60.7	72.7	75.7	112.7	112	0.7	6	1
	20	<input type="checkbox"/>	MPS0400-L20C	80.7	92.7	95.7	132.7	132	0.7	6	1
	25	<input type="checkbox"/>	MPS0400-L25C	100.7	112.7	115.7	152.7	152	0.7	6	1
	30	<input type="checkbox"/>	MPS0400-L30C	120.7	132.7	135.7	172.7	172	0.7	6	1
	35	<input type="checkbox"/>	MPS0400-L35C	140.7	152.7	155.7	192.7	192	0.7	6	1
40	<input type="checkbox"/>	MPS0400-L40C	160.7	172.7	175.7	212.7	212	0.7	6	1	

DC (mm)	Głębokość otworu (L/D)	VP15TF	Numer zamówieniowy	Wymiary (mm)							Typ
				LU	LCF	LH	OAL	LF	PL	DCON	
4.05	3	<input type="checkbox"/>	MPS0405S-DIN-C	17.7	23.7	28.7	65.7	65	0.7	6	1
	5	<input type="checkbox"/>	MPS0405L-DIN-C	29.7	35.7	36.7	73.7	73	0.7	6	1
4.1	3	<input type="checkbox"/>	MPS0410S-DIN-C	17.6	23.7	28.7	65.7	65	0.7	6	1
	5	<input type="checkbox"/>	MPS0410L-DIN-C	29.6	35.7	36.7	73.7	73	0.7	6	1
	8	<input type="checkbox"/>	MPS0410-L8C	33.5	50.7	53.7	90.7	90	0.7	6	1
	10	<input type="checkbox"/>	MPS0410-L10C	41.7	59.7	62.7	99.7	99	0.7	6	1
	12	<input type="checkbox"/>	MPS0410-L12C	49.9	68.7	71.7	108.7	108	0.7	6	1
	15	<input type="checkbox"/>	MPS0410-L15C	62.2	81.7	84.7	121.7	121	0.7	6	1
	20	<input type="checkbox"/>	MPS0410-L20C	82.7	104.7	107.7	144.7	144	0.7	6	1
	25	<input type="checkbox"/>	MPS0410-L25C	103.2	126.7	129.7	166.7	166	0.7	6	1
	30	<input type="checkbox"/>	MPS0410-L30C	123.7	149.7	152.7	189.7	189	0.7	6	1
	35	<input type="checkbox"/>	MPS0410-L35C	144.2	165.7	174.7	211.7	211	0.7	6	1
40	<input type="checkbox"/>	MPS0410-L40C	164.7	185.7	198.7	235.7	235	0.7	6	1	
4.2	3	<input type="checkbox"/>	MPS0420S-DIN-C	17.5	23.8	28.8	65.8	65	0.8	6	1
	5	<input type="checkbox"/>	MPS0420L-DIN-C	29.5	35.8	36.8	73.8	73	0.8	6	1
	8	<input type="checkbox"/>	MPS0420-L8C	34.4	50.8	53.8	90.8	90	0.8	6	1
	10	<input type="checkbox"/>	MPS0420-L10C	42.8	59.8	62.8	99.8	99	0.8	6	1
	12	<input type="checkbox"/>	MPS0420-L12C	51.2	68.8	71.8	108.8	108	0.8	6	1
	15	<input type="checkbox"/>	MPS0420-L15C	63.8	81.8	84.8	121.8	121	0.8	6	1
	20	<input type="checkbox"/>	MPS0420-L20C	84.8	104.8	107.8	144.8	144	0.8	6	1
	25	<input type="checkbox"/>	MPS0420-L25C	105.8	126.8	129.8	166.8	166	0.8	6	1
	30	<input type="checkbox"/>	MPS0420-L30C	126.8	149.8	152.8	189.8	189	0.8	6	1
	35	<input type="checkbox"/>	MPS0420-L35C	147.8	165.8	174.8	211.8	211	0.8	6	1
40	<input type="checkbox"/>	MPS0420-L40C	168.8	185.8	198.8	235.8	235	0.8	6	1	
4.3	3	<input type="checkbox"/>	MPS0430S-DIN-C	17.3	23.8	28.8	65.8	65	0.8	6	1
	5	<input type="checkbox"/>	MPS0430L-DIN-C	29.3	35.8	36.8	73.8	73	0.8	6	1
	8	<input type="checkbox"/>	MPS0430-L8C	35.2	50.8	53.8	90.8	90	0.8	6	1
	10	<input type="checkbox"/>	MPS0430-L10C	43.8	59.8	62.8	99.8	99	0.8	6	1
	12	<input type="checkbox"/>	MPS0430-L12C	52.4	68.8	71.8	108.8	108	0.8	6	1
	15	<input type="checkbox"/>	MPS0430-L15C	65.3	81.8	84.8	121.8	121	0.8	6	1
	20	<input type="checkbox"/>	MPS0430-L20C	86.8	104.8	107.8	144.8	144	0.8	6	1
	25	<input type="checkbox"/>	MPS0430-L25C	108.3	126.8	129.8	166.8	166	0.8	6	1
	30	<input type="checkbox"/>	MPS0430-L30C	129.8	149.8	152.8	189.8	189	0.8	6	1
	35	<input type="checkbox"/>	MPS0430-L35C	151.3	171.8	174.8	211.8	211	0.8	6	1
40	<input type="checkbox"/>	MPS0430-L40C	172.8	195.8	198.8	235.8	235	0.8	6	1	
4.4	3	<input type="checkbox"/>	MPS0440S-DIN-C	17.2	23.8	28.8	65.8	65	0.8	6	1
	5	<input type="checkbox"/>	MPS0440L-DIN-C	29.2	35.8	36.8	73.8	73	0.8	6	1
	8	<input type="checkbox"/>	MPS0440-L8C	36.0	50.8	53.8	90.8	90	0.8	6	1
	10	<input type="checkbox"/>	MPS0440-L10C	44.8	59.8	62.8	99.8	99	0.8	6	1
	12	<input type="checkbox"/>	MPS0440-L12C	53.6	68.8	71.8	108.8	108	0.8	6	1
	15	<input type="checkbox"/>	MPS0440-L15C	66.8	81.8	84.8	121.8	121	0.8	6	1
	20	<input type="checkbox"/>	MPS0440-L20C	88.8	104.8	107.8	144.8	144	0.8	6	1
	25	<input type="checkbox"/>	MPS0440-L25C	110.8	126.8	129.8	166.8	166	0.8	6	1
	30	<input type="checkbox"/>	MPS0440-L30C	132.8	149.8	152.8	189.8	189	0.8	6	1
	35	<input type="checkbox"/>	MPS0440-L35C	154.8	171.8	174.8	211.8	211	0.8	6	1
40	<input type="checkbox"/>	MPS0440-L40C	176.8	195.8	198.8	235.8	235	0.8	6	1	
4.5	3	<input type="checkbox"/>	MPS0450S-DIN-C	17.1	23.8	28.8	65.8	65	0.8	6	1
	5	<input type="checkbox"/>	MPS0450L-DIN-C	29.1	35.8	36.8	73.8	73	0.8	6	1
	8	<input type="checkbox"/>	MPS0450-L8C	36.8	50.8	53.8	90.8	90	0.8	6	1
	10	<input type="checkbox"/>	MPS0450-L10C	45.8	59.8	62.8	99.8	99	0.8	6	1
	12	<input type="checkbox"/>	MPS0450-L12C	54.8	68.8	71.8	108.8	108	0.8	6	1
	15	<input type="checkbox"/>	MPS0450-L15C	68.3	81.8	84.8	121.8	121	0.8	6	1
	20	<input type="checkbox"/>	MPS0450-L20C	90.8	104.8	107.8	144.8	144	0.8	6	1
	25	<input type="checkbox"/>	MPS0450-L25C	113.3	126.8	129.8	166.8	166	0.8	6	1
	30	<input type="checkbox"/>	MPS0450-L30C	135.8	149.8	152.8	189.8	189	0.8	6	1
	35	<input type="checkbox"/>	MPS0450-L35C	158.3	171.8	174.8	211.8	211	0.8	6	1
40	<input type="checkbox"/>	MPS0450-L40C	180.8	195.8	198.8	235.8	235	0.8	6	1	

WIERCENIE (WIERTŁA PEŁNOWĘGLIKOWE)

MPS

Wiertła z podwójną łysinką
i wiertła super długie

WĘGLIKI
SPIEKANE

WIERCENIE

M

DC (mm)	Głębokość otworu (L/D)	VP15TF	Numer zamówieniowy	Wymiary (mm)							Typ
				LU	LCF	LH	OAL	LF	PL	DCON	
4.6	3	<input type="checkbox"/>	MPS0460S-DIN-C	16.9	23.8	28.8	65.8	65	0.8	6	1
	5	<input type="checkbox"/>	MPS0460L-DIN-C	28.9	35.8	36.8	73.8	73	0.8	6	1
	8	<input type="checkbox"/>	MPS0460-L8C	37.6	55.8	58.8	95.8	95	0.8	6	1
	10	<input type="checkbox"/>	MPS0460-L10C	46.8	65.8	68.8	105.8	105	0.8	6	1
	12	<input type="checkbox"/>	MPS0460-L12C	56.0	75.8	78.8	115.8	115	0.8	6	1
	15	<input type="checkbox"/>	MPS0460-L15C	69.8	90.8	93.8	130.8	130	0.8	6	1
	20	<input type="checkbox"/>	MPS0460-L20C	92.8	115.8	118.8	155.8	155	0.8	6	1
	25	<input type="checkbox"/>	MPS0460-L25C	115.8	140.8	143.8	180.8	180	0.8	6	1
	30	<input type="checkbox"/>	MPS0460-L30C	138.8	165.8	168.8	205.8	205	0.8	6	1
	35	<input type="checkbox"/>	MPS0460-L35C	161.8	184.8	192.8	229.8	229	0.8	6	1
	40	<input type="checkbox"/>	MPS0460-L40C	184.8	204.8	217.8	254.8	254	0.8	6	1
	4.65	3	<input type="checkbox"/>	MPS0465S-DIN-C	16.9	23.8	28.8	65.8	65	0.8	6
5		<input type="checkbox"/>	MPS0465L-DIN-C	28.9	35.8	36.8	73.8	73	0.8	6	1
4.7	3	<input type="checkbox"/>	MPS0470S-DIN-C	16.8	23.9	28.9	65.9	65	0.9	6	1
	5	<input type="checkbox"/>	MPS0470L-DIN-C	28.8	35.9	36.9	73.9	73	0.9	6	1
	8	<input type="checkbox"/>	MPS0470-L8C	38.5	55.9	58.9	95.9	95	0.9	6	1
	10	<input type="checkbox"/>	MPS0470-L10C	47.9	65.9	68.9	105.9	105	0.9	6	1
	12	<input type="checkbox"/>	MPS0470-L12C	57.3	75.9	78.9	115.9	115	0.9	6	1
	15	<input type="checkbox"/>	MPS0470-L15C	71.4	90.9	93.9	130.9	130	0.9	6	1
	20	<input type="checkbox"/>	MPS0470-L20C	94.9	115.9	118.9	155.9	155	0.9	6	1
	25	<input type="checkbox"/>	MPS0470-L25C	118.4	140.9	143.9	180.9	180	0.9	6	1
	30	<input type="checkbox"/>	MPS0470-L30C	141.9	165.9	168.9	205.9	205	0.9	6	1
	35	<input type="checkbox"/>	MPS0470-L35C	165.4	184.9	192.9	229.9	229	0.9	6	1
	40	<input type="checkbox"/>	MPS0470-L40C	188.9	204.9	217.9	254.9	254	0.9	6	1
	4.8	3	<input type="checkbox"/>	MPS0480S-DIN-C	20.7	27.9	28.9	65.9	65	0.9	6
5		<input type="checkbox"/>	MPS0480L-DIN-C	36.7	43.9	44.9	81.9	81	0.9	6	1
8		<input type="checkbox"/>	MPS0480-L8C	39.3	55.9	58.9	95.9	95	0.9	6	1
10		<input type="checkbox"/>	MPS0480-L10C	48.9	65.9	68.9	105.9	105	0.9	6	1
12		<input type="checkbox"/>	MPS0480-L12C	58.5	75.9	78.9	115.9	115	0.9	6	1
15		<input type="checkbox"/>	MPS0480-L15C	72.9	90.9	93.9	130.9	130	0.9	6	1
20		<input type="checkbox"/>	MPS0480-L20C	96.9	115.9	118.9	155.9	155	0.9	6	1
25		<input type="checkbox"/>	MPS0480-L25C	120.9	140.9	143.9	180.9	180	0.9	6	1
30		<input type="checkbox"/>	MPS0480-L30C	144.9	165.9	168.9	205.9	205	0.9	6	1
35		<input type="checkbox"/>	MPS0480-L35C	168.9	190.9	192.9	229.9	229	0.9	6	1
40		<input type="checkbox"/>	MPS0480-L40C	192.9	215.9	217.9	254.9	254	0.9	6	1
4.9		3	<input type="checkbox"/>	MPS0490S-DIN-C	20.5	27.9	28.9	65.9	65	0.9	6
	5	<input type="checkbox"/>	MPS0490L-DIN-C	36.5	43.9	44.9	81.9	81	0.9	6	1
	8	<input type="checkbox"/>	MPS0490-L8C	40.1	55.9	58.9	95.9	95	0.9	6	1
	10	<input type="checkbox"/>	MPS0490-L10C	49.9	65.9	68.9	105.9	105	0.9	6	1
	12	<input type="checkbox"/>	MPS0490-L12C	59.7	75.9	78.9	115.9	115	0.9	6	1
	15	<input type="checkbox"/>	MPS0490-L15C	74.4	90.9	93.9	130.9	130	0.9	6	1
	20	<input type="checkbox"/>	MPS0490-L20C	98.9	115.9	118.9	155.9	155	0.9	6	1
	25	<input type="checkbox"/>	MPS0490-L25C	123.4	140.9	143.9	180.9	180	0.9	6	1
	30	<input type="checkbox"/>	MPS0490-L30C	147.9	165.9	168.9	205.9	205	0.9	6	1
	35	<input type="checkbox"/>	MPS0490-L35C	172.4	190.9	192.9	229.9	229	0.9	6	1
	40	<input type="checkbox"/>	MPS0490-L40C	196.9	215.9	217.9	254.9	254	0.9	6	1
	5.0	3	<input type="checkbox"/>	MPS0500S-DIN-C	20.4	27.9	28.9	65.9	65	0.9	6
5		<input type="checkbox"/>	MPS0500L-DIN-C	36.4	43.9	44.9	81.9	81	0.9	6	1
8		<input type="checkbox"/>	MPS0500-L8C	40.9	55.9	58.9	95.9	95	0.9	6	1
10		<input type="checkbox"/>	MPS0500-L10C	50.9	65.9	68.9	105.9	105	0.9	6	1
12		<input type="checkbox"/>	MPS0500-L12C	60.9	75.9	78.9	115.9	115	0.9	6	1
15		<input type="checkbox"/>	MPS0500-L15C	75.9	90.9	93.9	130.9	130	0.9	6	1
20		<input type="checkbox"/>	MPS0500-L20C	100.9	115.9	118.9	155.9	155	0.9	6	1
25		<input type="checkbox"/>	MPS0500-L25C	125.9	140.9	143.9	180.9	180	0.9	6	1
30		<input type="checkbox"/>	MPS0500-L30C	150.9	165.9	168.9	205.9	205	0.9	6	1
35		<input type="checkbox"/>	MPS0500-L35C	175.9	190.9	192.9	229.9	229	0.9	6	1
40		<input type="checkbox"/>	MPS0500-L40C	200.9	215.9	217.9	254.9	254	0.9	6	1
5.05		3	<input type="checkbox"/>	MPS0505S-DIN-C	20.3	27.9	28.9	65.9	65	0.9	6
	5	<input type="checkbox"/>	MPS0505L-DIN-C	36.3	43.9	44.9	81.9	81	0.9	6	1
	8	<input type="checkbox"/>	MPS0510S-DIN-C	20.3	27.9	28.9	65.9	65	0.9	6	1
	10	<input type="checkbox"/>	MPS0510L-DIN-C	36.3	43.9	44.9	81.9	81	0.9	6	1
	12	<input type="checkbox"/>	MPS0510-L8C	41.7	61.9	64.9	101.9	101	0.9	6	1
	15	<input type="checkbox"/>	MPS0510-L10C	51.9	72.9	75.9	112.9	112	0.9	6	1
	20	<input type="checkbox"/>	MPS0510-L12C	62.1	83.9	86.9	123.9	123	0.9	6	1
	25	<input type="checkbox"/>	MPS0510-L15C	77.4	99.9	102.9	139.9	139	0.9	6	1
	30	<input type="checkbox"/>	MPS0510-L20C	102.9	127.9	130.9	167.9	167	0.9	6	1
	35	<input type="checkbox"/>	MPS0510-L25C	128.4	154.9	157.9	194.9	194	0.9	6	1
	40	<input type="checkbox"/>	MPS0510-L30C	153.9	182.9	185.9	222.9	222	0.9	6	1
	5.1	3	<input type="checkbox"/>	MPS0520S-DIN-C	20.1	27.9	28.9	65.9	65	0.9	6
5		<input type="checkbox"/>	MPS0520L-DIN-C	36.1	43.9	44.9	81.9	81	0.9	6	1
8		<input type="checkbox"/>	MPS0520-L8C	42.5	61.9	64.9	101.9	101	0.9	6	1
10		<input type="checkbox"/>	MPS0520-L10C	52.9	72.9	75.9	112.9	112	0.9	6	1
12		<input type="checkbox"/>	MPS0520-L12C	63.3	83.9	86.9	123.9	123	0.9	6	1
15		<input type="checkbox"/>	MPS0520-L15C	78.9	99.9	102.9	139.9	139	0.9	6	1
20		<input type="checkbox"/>	MPS0520-L20C	104.9	127.9	130.9	167.9	167	0.9	6	1
25		<input type="checkbox"/>	MPS0520-L25C	130.9	154.9	157.9	194.9	194	0.9	6	1
30		<input type="checkbox"/>	MPS0520-L30C	156.9	182.9	185.9	222.9	222	0.9	6	1
35		<input type="checkbox"/>	MPS0520-L35C	182.9	203.9	211.9	248.9	248	0.9	6	1
40		<input type="checkbox"/>	MPS0520-L40C	208.9	230.9	241.9	278.9	278	0.9	6	1
5.2		3	<input type="checkbox"/>	MPS0530S-DIN-C	20.0	28.0	29.0	66.0	65	1.0	6
	5	<input type="checkbox"/>	MPS0530L-DIN-C	36.0	44.0	45.0	82.0	81	1.0	6	1
	8	<input type="checkbox"/>	MPS0530-L8C	43.4	62.0	65.0	102.0	101	1.0	6	1
	10	<input type="checkbox"/>	MPS0530-L10C	54.0	73.0	76.0	113.0	112	1.0	6	1
	12	<input type="checkbox"/>	MPS0530-L12C	64.6	84.0	87.0	124.0	123	1.0	6	1
	15	<input type="checkbox"/>	MPS0530-L15C	80.5	100.0	103.0	140.0	139	1.0	6	1
	20	<input type="checkbox"/>	MPS0530-L20C	107.0	128.0	131.0	168.0	167	1.0	6	1
	25	<input type="checkbox"/>	MPS0530-L25C	133.5	155.0	158.0	195.0	194	1.0	6	1
	30	<input type="checkbox"/>	MPS0530-L30C	160.0	183.0	186.0	223.0	222	1.0	6	1
	35	<input type="checkbox"/>	MPS0530-L35C	186.5	210.0	212.0	249.0	248	1.0	6	1
	40	<input type="checkbox"/>	MPS0530-L40C	213.0	241.0	242.0	279.0	278	1.0	6	1
	5.3	3	<input type="checkbox"/>	MPS0540S-DIN-C	19.9	28.0	29.0	66.0	65	1.0	6
5		<input type="checkbox"/>	MPS0540L-DIN-C	35.9	44.0	45.0	82.0	81	1.0	6	1
8		<input type="checkbox"/>	MPS0540-L8C	44.2	62.0	65.0	102.0	101	1.0	6	1
10		<input type="checkbox"/>	MPS0540-L10C	55.0	73.0	76.0	113.0	112	1.0	6	1
12		<input type="checkbox"/>	MPS0540-L12C	65.8	84.0	87.0	124.0	123	1.0	6	1
15		<input type="checkbox"/>	MPS0540-L15C	82.0	100.0	103.0	140.0	139	1.0	6	1
20		<input type="checkbox"/>	MPS0540-L20C	109.0	128.0	131.0	168.0	167	1.0	6	1
25		<input type="checkbox"/>	MPS0540-L25C	136.0	155.0	158.0	195.0	194	1.0	6	1
30		<input type="checkbox"/>	MPS0540-L30C	163.0	183.0	186.0	223.0	222	1.0	6	1
35		<input type="checkbox"/>	MPS0540-L35C	190.0	210.0	212.0	249.0	248	1.0	6	1
40		<input type="checkbox"/>	MPS0540-L40C	217.0	241.0	242.0	279.0	278	1.0	6	1
5.4		3	<input type="checkbox"/>	MPS0550S-DIN-C	19.8	28.0	29.0	66.0	65	1.0	6
	5	<input type="checkbox"/>	MPS0550L-DIN-C	35.8	44.0	45.0	82.0	81	1.0	6	1
	8	<input type="checkbox"/>	MPS0550-L8C	45.0	62.0	65.0	102.0	101	1.0	6	1
	10	<input type="checkbox"/>	MPS0550-L10C	56.0	73.0	76.0	113.0	112	1.0	6	1
	12	<input type="checkbox"/>	MPS0550-L12C	67.0	84.0	87.0	124.0	123	1.0	6	1
	15	<input type="checkbox"/>	MPS0550-L15C	83.5	100.0	103.0	140.0	139	1.0	6	1
	20	<input type="checkbox"/>	MPS0550-L20C	111.0	128.0	131.0	168.0	167	1.0	6	1
	25	<input type="checkbox"/>	MPS0550-L25C	138.5	155.0	158.0	195.0	194	1.0	6	1
	30	<input type="checkbox"/>	MPS0550-L30C	166.0	183.0	186.0	223.0	222	1.0	6	1
	35	<input type="checkbox"/>	MPS0550-L35C	193.5	210.0	212.0	249.0	248	1.0	6	1
	40	<input type="checkbox"/>	MPS0550-L40C	221.0	241.0	242.0	279.0	278	1.0	6	1
	5.5	3	<input type="checkbox"/>	MPS0555S-DIN-C	19.8	28.0	29.0	66.0	65	1.0	6
5		<input type="checkbox"/>	MPS0555L-DIN-C	35.8	44.0	45.0	82.0	81	1.0	6	1
8		<input type="checkbox"/>	MPS0555-L8C	45.0	62.0	65.0	102.0	101	1.0	6	1
10		<input type="checkbox"/>	MPS0555-L10C	56.0	73.0	76.0	113.0	112	1.0	6	1
12		<input type="checkbox"/>	MPS0555-L12C	67.0	84.0	87.0	124.0	123	1.0	6	1
15		<input type="checkbox"/>	MPS0555-L15C	83.5	100.0	103.0	140.0	139	1.0	6	1
20		<input type="checkbox"/>	MPS0555-L20C	111.0	128.0	131.0	168.0	167	1.0	6	1

DC (mm)	Głębokość otworu (L/D)	VP15TF	Numer zamówieniowy	Wymiary (mm)							Typ
				LU	LCF	LH	OAL	LF	PL	DCON	
5.55	3	<input type="checkbox"/>	MPS0555S-DIN-C	19.7	28.0	29.0	66.0	65	1.0	6	1
	5	<input type="checkbox"/>	MPS0555L-DIN-C	35.7	44.0	45.0	82.0	81	1.0	6	1
5.6	3	<input type="checkbox"/>	MPS0560S-DIN-C	19.6	28.0	29.0	66.0	65	1.0	6	1
	5	<input type="checkbox"/>	MPS0560L-DIN-C	35.6	44.0	45.0	82.0	81	1.0	6	1
	8	<input type="checkbox"/>	MPS0560-L8C	45.8	67.0	70.0	107.0	106	1.0	6	1
	10	<input type="checkbox"/>	MPS0560-L10C	57.0	79.0	82.0	119.0	118	1.0	6	1
	12	<input type="checkbox"/>	MPS0560-L12C	68.2	91.0	94.0	131.0	130	1.0	6	1
	15	<input type="checkbox"/>	MPS0560-L15C	85.0	109.0	112.0	149.0	148	1.0	6	1
	20	<input type="checkbox"/>	MPS0560-L20C	113.0	139.0	142.0	179.0	178	1.0	6	1
	25	<input type="checkbox"/>	MPS0560-L25C	141.0	169.0	172.0	209.0	208	1.0	6	1
	30	<input type="checkbox"/>	MPS0560-L30C	169.0	199.0	202.0	239.0	238	1.0	6	1
	35	<input type="checkbox"/>	MPS0560-L35C	197.0	223.0	231.0	268.0	267	1.0	6	1
5.7	3	<input type="checkbox"/>	MPS0570S-DIN-C	19.5	28.0	29.0	66.0	65	1.0	6	1
	5	<input type="checkbox"/>	MPS0570L-DIN-C	35.5	44.0	45.0	82.0	81	1.0	6	1
	8	<input type="checkbox"/>	MPS0570-L8C	46.6	67.0	70.0	107.0	106	1.0	6	1
	10	<input type="checkbox"/>	MPS0570-L10C	58.0	79.0	82.0	119.0	118	1.0	6	1
	12	<input type="checkbox"/>	MPS0570-L12C	69.4	91.0	94.0	131.0	130	1.0	6	1
	15	<input type="checkbox"/>	MPS0570-L15C	86.5	109.0	112.0	149.0	148	1.0	6	1
	20	<input type="checkbox"/>	MPS0570-L20C	115.0	139.0	142.0	179.0	178	1.0	6	1
	25	<input type="checkbox"/>	MPS0570-L25C	143.5	169.0	172.0	209.0	208	1.0	6	1
	30	<input type="checkbox"/>	MPS0570-L30C	172.0	199.0	202.0	239.0	238	1.0	6	1
	35	<input type="checkbox"/>	MPS0570-L35C	200.5	223.0	231.0	268.0	267	1.0	6	1
5.8	3	<input type="checkbox"/>	MPS0580S-DIN-C	19.4	28.1	29.1	66.1	65	1.1	6	1
	5	<input type="checkbox"/>	MPS0580L-DIN-C	35.4	44.1	45.1	82.1	81	1.1	6	1
	8	<input type="checkbox"/>	MPS0580-L8C	47.5	67.1	70.1	107.1	106	1.1	6	1
	10	<input type="checkbox"/>	MPS0580-L10C	59.1	79.1	82.1	119.1	118	1.1	6	1
	12	<input type="checkbox"/>	MPS0580-L12C	70.7	91.1	94.1	131.1	130	1.1	6	1
	15	<input type="checkbox"/>	MPS0580-L15C	88.1	109.1	112.1	149.1	148	1.1	6	1
	20	<input type="checkbox"/>	MPS0580-L20C	117.1	139.1	142.1	179.1	178	1.1	6	1
	25	<input type="checkbox"/>	MPS0580-L25C	146.1	169.1	172.1	209.1	208	1.1	6	1
	30	<input type="checkbox"/>	MPS0580-L30C	175.1	199.1	202.1	239.1	238	1.1	6	1
	35	<input type="checkbox"/>	MPS0580-L35C	204.1	229.1	231.1	268.1	267	1.1	6	1
5.9	3	<input type="checkbox"/>	MPS0590S-DIN-C	19.2	28.1	29.1	66.1	65	1.1	6	1
	5	<input type="checkbox"/>	MPS0590L-DIN-C	35.2	44.1	45.1	82.1	81	1.1	6	1
	8	<input type="checkbox"/>	MPS0590-L8C	48.3	67.1	70.1	107.1	106	1.1	6	1
	10	<input type="checkbox"/>	MPS0590-L10C	60.1	79.1	82.1	119.1	118	1.1	6	1
	12	<input type="checkbox"/>	MPS0590-L12C	71.9	91.1	94.1	131.1	130	1.1	6	1
	15	<input type="checkbox"/>	MPS0590-L15C	89.6	109.1	112.1	149.1	148	1.1	6	1
	20	<input type="checkbox"/>	MPS0590-L20C	119.1	139.1	142.1	179.1	178	1.1	6	1
	25	<input type="checkbox"/>	MPS0590-L25C	148.6	169.1	172.1	209.1	208	1.1	6	1
	30	<input type="checkbox"/>	MPS0590-L30C	178.1	199.1	202.1	239.1	238	1.1	6	1
	35	<input type="checkbox"/>	MPS0590-L35C	207.6	229.1	231.1	268.1	267	1.1	6	1
6.0	3	<input type="checkbox"/>	MPS0600S-DIN-C	19.1	28.1	29.1	66.1	65	1.1	6	2
	5	<input type="checkbox"/>	MPS0600L-DIN-C	35.1	44.1	45.1	82.1	81	1.1	6	2
	8	<input type="checkbox"/>	MPS0600-L8C	49.1	67.1	70.1	107.1	106	1.1	6	2
	10	<input type="checkbox"/>	MPS0600-L10C	61.1	79.1	82.1	119.1	118	1.1	6	2
	12	<input type="checkbox"/>	MPS0600-L12C	73.1	91.1	94.1	131.1	130	1.1	6	2
	15	<input type="checkbox"/>	MPS0600-L15C	91.1	109.1	112.1	149.1	148	1.1	6	2
	20	<input type="checkbox"/>	MPS0600-L20C	121.1	139.1	142.1	179.1	178	1.1	6	2
	25	<input type="checkbox"/>	MPS0600-L25C	151.1	169.1	172.1	209.1	208	1.1	6	2
	30	<input type="checkbox"/>	MPS0600-L30C	181.1	199.1	202.1	239.1	238	1.1	6	2
	35	<input type="checkbox"/>	MPS0600-L35C	211.1	229.1	231.1	268.1	267	1.1	6	2

DC (mm)	Głębokość otworu (L/D)	VP15TF	Numer zamówieniowy	Wymiary (mm)							Typ
				LU	LCF	LH	OAL	LF	PL	DCON	
6.05	3	<input type="checkbox"/>	MPS0605S-DIN-C	25.0	34.1	42.1	79.1	78	1.1	8	1
	5	<input type="checkbox"/>	MPS0605L-DIN-C	44.0	53.1	54.1	91.1	90	1.1	8	1
6.1	3	<input type="checkbox"/>	MPS0610S-DIN-C	25.0	34.1	42.1	79.1	78	1.1	8	1
	5	<input type="checkbox"/>	MPS0610L-DIN-C	44.0	53.1	54.1	91.1	90	1.1	8	1
	8	<input type="checkbox"/>	MPS0610-L8C	49.9	73.1	76.1	113.1	112	1.1	8	1
	10	<input type="checkbox"/>	MPS0610-L10C	62.1	86.1	89.1	126.1	125	1.1	8	1
	12	<input type="checkbox"/>	MPS0610-L12C	74.3	99.1	102.1	139.1	138	1.1	8	1
	15	<input type="checkbox"/>	MPS0610-L15C	92.6	118.1	121.1	158.1	157	1.1	8	1
	20	<input type="checkbox"/>	MPS0610-L20C	123.1	151.1	154.1	191.1	190	1.1	8	1
	25	<input type="checkbox"/>	MPS0610-L25C	153.6	183.1	186.1	223.1	222	1.1	8	1
	30	<input type="checkbox"/>	MPS0610-L30C	184.1	216.1	219.1	256.1	255	1.1	8	1
	35	<input type="checkbox"/>	MPS0610-L35C	214.6	241.1	250.1	287.1	286	1.1	8	1
6.2	3	<input type="checkbox"/>	MPS0620S-DIN-C	24.8	34.1	42.1	79.1	78	1.1	8	1
	5	<input type="checkbox"/>	MPS0620L-DIN-C	43.8	53.1	54.1	91.1	90	1.1	8	1
	8	<input type="checkbox"/>	MPS0620-L8C	50.7	73.1	76.1	113.1	112	1.1	8	1
	10	<input type="checkbox"/>	MPS0620-L10C	63.1	86.1	89.1	126.1	125	1.1	8	1
	12	<input type="checkbox"/>	MPS0620-L12C	75.5	99.1	102.1	139.1	138	1.1	8	1
	15	<input type="checkbox"/>	MPS0620-L15C	94.1	118.1	121.1	158.1	157	1.1	8	1
	20	<input type="checkbox"/>	MPS0620-L20C	125.1	151.1	154.1	191.1	190	1.1	8	1
	25	<input type="checkbox"/>	MPS0620-L25C	156.1	183.1	186.1	223.1	222	1.1	8	1
	30	<input type="checkbox"/>	MPS0620-L30C	187.1	216.1	219.1	256.1	255	1.1	8	1
	35	<input type="checkbox"/>	MPS0620-L35C	218.1	241.1	250.1	287.1	286	1.1	8	1
6.3	3	<input type="checkbox"/>	MPS0630S-DIN-C	24.7	34.1	42.1	79.1	78	1.1	8	1
	5	<input type="checkbox"/>	MPS0630L-DIN-C	43.7	53.1	54.1	91.1	90	1.1	8	1
	8	<input type="checkbox"/>	MPS0630-L8C	51.5	73.1	76.1	113.1	112	1.1	8	1
	10	<input type="checkbox"/>	MPS0630-L10C	64.1	86.1	89.1	126.1	125	1.1	8	1
	12	<input type="checkbox"/>	MPS0630-L12C	76.7	99.1	102.1	139.1	138	1.1	8	1
	15	<input type="checkbox"/>	MPS0630-L15C	95.6	118.1	121.1	158.1	157	1.1	8	1
	20	<input type="checkbox"/>	MPS0630-L20C	127.1	151.1	154.1	191.1	190	1.1	8	1
	25	<input type="checkbox"/>	MPS0630-L25C	158.6	183.1	186.1	223.1	222	1.1	8	1
	30	<input type="checkbox"/>	MPS0630-L30C	190.1	216.1	219.1	256.1	255	1.1	8	1
	35	<input type="checkbox"/>	MPS0630-L35C	221.6	248.1	250.1	287.1	286	1.1	8	1
6.4	3	<input type="checkbox"/>	MPS0640S-DIN-C	24.6	34.2	42.2	79.2	78	1.2	8	1
	5	<input type="checkbox"/>	MPS0640L-DIN-C	43.6	53.2	54.2	91.2	90	1.2	8	1
	8	<input type="checkbox"/>	MPS0640-L8C	52.4	73.2	76.2	113.2	112	1.2	8	1
	10	<input type="checkbox"/>	MPS0640-L10C	65.2	86.2	89.2	126.2	125	1.2	8	1
	12	<input type="checkbox"/>	MPS0640-L12C	78.0	99.2	102.2	139.2	138	1.2	8	1
	15	<input type="checkbox"/>	MPS0640-L15C	97.2	118.2	121.2	158.2	157	1.2	8	1
	20	<input type="checkbox"/>	MPS0640-L20C	129.2	151.2	154.2	191.2	190	1.2	8	1
	25	<input type="checkbox"/>	MPS0640-L25C	161.2	183.2	186.2	223.2	222	1.2	8	1
	30	<input type="checkbox"/>	MPS0640-L30C	193.2	216.2	219.2	256.2	255	1.2	8	1
	35	<input type="checkbox"/>	MPS0640-L35C	225.2	248.2	250.2	287.2	286	1.2	8	1
6.5	3	<input type="checkbox"/>	MPS0650S-DIN-C	24.4	34.2	42.2	79.2	78	1.2	8	1
	5	<input type="checkbox"/>	MPS0650L-DIN-C	43.4	53.2	54.2	91.2	90	1.2	8	1
	8	<input type="checkbox"/>	MPS0650-L8C	53.2	73.2	76.2	113.2	112	1.2	8	1
	10	<input type="checkbox"/>	MPS0650-L10C	66.2	86.2	89.2	126.2	125	1.2	8	1
	12	<input type="checkbox"/>	MPS0650-L12C	79.2	99.2	102.2	139.2	138	1.2	8	1
	15	<input type="checkbox"/>	MPS0650-L15C	98.7	118.2	121.2	158.2	157	1.2	8	1
	20	<input type="checkbox"/>	MPS0650-L20C	131.2	151.2	154.2	191.2	190	1.2	8	1
	25	<input type="checkbox"/>	MPS0650-L25C	163.7	183.2	186.2	223.2	222	1.2	8	1
	30	<input type="checkbox"/>	MPS0650-L30C	196.2	216.2	219.2	256.2	255	1.2	8	1
	35	<input type="checkbox"/>	MPS0650-L35C	228.7	248.2	250.2	287.2	286	1.2		

WIERCENIE (WIERTŁA PEŁNOWĘGLIKOWE)

MPS

Wiertła z podwójną łysinką
i wiertła super długie

WĘGLIKI
SPIEKANE

M
WIERCENIE

DC (mm)	Głębokość otworu (L/D)	VP15TF	Numer zamówieniowy	Wymiary (mm)								Typ
				LU	LCF	LH	OAL	LF	PL	DCON		
6.6	3	<input type="checkbox"/>	MPS0660S-DIN-C	24.3	34.2	42.2	79.2	78	1.2	8	1	
	5	<input type="checkbox"/>	MPS0660L-DIN-C	43.3	53.2	54.2	91.2	90	1.2	8	1	
	8	<input type="checkbox"/>	MPS0660-L8C	54.0	78.2	81.2	118.2	117	1.2	8	1	
	10	<input type="checkbox"/>	MPS0660-L10C	67.2	92.2	95.2	132.2	131	1.2	8	1	
	12	<input type="checkbox"/>	MPS0660-L12C	80.4	106.2	109.2	146.2	145	1.2	8	1	
	15	<input type="checkbox"/>	MPS0660-L15C	100.2	127.2	130.2	167.2	166	1.2	8	1	
	20	<input type="checkbox"/>	MPS0660-L20C	133.2	162.2	165.2	202.2	201	1.2	8	1	
	25	<input type="checkbox"/>	MPS0660-L25C	166.2	197.2	200.2	237.2	236	1.2	8	1	
	30	<input type="checkbox"/>	MPS0660-L30C	199.2	232.2	235.2	272.2	271	1.2	8	1	
	35	<input type="checkbox"/>	MPS0660-L35C	232.2	267.2	269.2	306.2	305	1.2	8	1	
	40	<input type="checkbox"/>	MPS0660-L40C	265.2	301.2	304.2	341.2	340	1.2	8	1	
	6.7	3	<input type="checkbox"/>	MPS0670S-DIN-C	24.2	34.2	42.2	79.2	78	1.2	8	1
5		<input type="checkbox"/>	MPS0670L-DIN-C	43.2	53.2	54.2	91.2	90	1.2	8	1	
8		<input type="checkbox"/>	MPS0670-L8C	54.8	78.2	81.2	118.2	117	1.2	8	1	
10		<input type="checkbox"/>	MPS0670-L10C	68.2	92.2	95.2	132.2	131	1.2	8	1	
12		<input type="checkbox"/>	MPS0670-L12C	81.6	106.2	109.2	146.2	145	1.2	8	1	
15		<input type="checkbox"/>	MPS0670-L15C	101.7	127.2	130.2	167.2	166	1.2	8	1	
20		<input type="checkbox"/>	MPS0670-L20C	135.2	162.2	165.2	202.2	201	1.2	8	1	
25		<input type="checkbox"/>	MPS0670-L25C	168.7	197.2	200.2	237.2	236	1.2	8	1	
30		<input type="checkbox"/>	MPS0670-L30C	202.2	232.2	235.2	272.2	271	1.2	8	1	
35		<input type="checkbox"/>	MPS0670-L35C	235.7	267.2	269.2	306.2	305	1.2	8	1	
40		<input type="checkbox"/>	MPS0670-L40C	269.2	301.2	304.2	341.2	340	1.2	8	1	
6.8		3	<input type="checkbox"/>	MPS0680S-DIN-C	24.0	34.2	42.2	79.2	78	1.2	8	1
	5	<input type="checkbox"/>	MPS0680L-DIN-C	43.0	53.2	54.2	91.2	90	1.2	8	1	
	8	<input type="checkbox"/>	MPS0680-L8C	55.6	78.2	81.2	118.2	117	1.2	8	1	
	10	<input type="checkbox"/>	MPS0680-L10C	69.2	92.2	95.2	132.2	131	1.2	8	1	
	12	<input type="checkbox"/>	MPS0680-L12C	82.8	106.2	109.2	146.2	145	1.2	8	1	
	15	<input type="checkbox"/>	MPS0680-L15C	103.2	127.2	130.2	167.2	166	1.2	8	1	
	20	<input type="checkbox"/>	MPS0680-L20C	137.2	162.2	165.2	202.2	201	1.2	8	1	
	25	<input type="checkbox"/>	MPS0680-L25C	171.2	197.2	200.2	237.2	236	1.2	8	1	
	30	<input type="checkbox"/>	MPS0680-L30C	205.2	232.2	235.2	272.2	271	1.2	8	1	
	35	<input type="checkbox"/>	MPS0680-L35C	239.2	267.2	269.2	306.2	305	1.2	8	1	
	40	<input type="checkbox"/>	MPS0680-L40C	273.2	301.2	304.2	341.2	340	1.2	8	1	
	6.9	3	<input type="checkbox"/>	MPS0690S-DIN-C	23.9	34.3	42.3	79.3	78	1.3	8	1
5		<input type="checkbox"/>	MPS0690L-DIN-C	42.9	53.3	54.3	91.3	90	1.3	8	1	
8		<input type="checkbox"/>	MPS0690-L8C	56.5	78.3	81.3	118.3	117	1.3	8	1	
10		<input type="checkbox"/>	MPS0690-L10C	70.3	92.3	95.3	132.3	131	1.3	8	1	
12		<input type="checkbox"/>	MPS0690-L12C	84.1	106.3	109.3	146.3	145	1.3	8	1	
15		<input type="checkbox"/>	MPS0690-L15C	104.8	127.3	130.3	167.3	166	1.3	8	1	
20		<input type="checkbox"/>	MPS0690-L20C	139.3	162.3	165.3	202.3	201	1.3	8	1	
25		<input type="checkbox"/>	MPS0690-L25C	173.8	197.3	200.3	237.3	236	1.3	8	1	
30		<input type="checkbox"/>	MPS0690-L30C	208.3	232.3	235.3	272.3	271	1.3	8	1	
35		<input type="checkbox"/>	MPS0690-L35C	242.8	267.3	269.3	306.3	305	1.3	8	1	
40		<input type="checkbox"/>	MPS0690-L40C	277.3	301.3	304.3	341.3	340	1.3	8	1	
7.0		3	<input type="checkbox"/>	MPS0700S-DIN-C	23.8	34.3	42.3	79.3	78	1.3	8	1
	5	<input type="checkbox"/>	MPS0700L-DIN-C	42.8	53.3	54.3	91.3	90	1.3	8	1	
	8	<input type="checkbox"/>	MPS0700-L8C	57.3	78.3	81.3	118.3	117	1.3	8	1	
	10	<input type="checkbox"/>	MPS0700-L10C	71.3	92.3	95.3	132.3	131	1.3	8	1	
	12	<input type="checkbox"/>	MPS0700-L12C	85.3	106.3	109.3	146.3	145	1.3	8	1	
	15	<input type="checkbox"/>	MPS0700-L15C	106.3	127.3	130.3	167.3	166	1.3	8	1	
	20	<input type="checkbox"/>	MPS0700-L20C	141.3	162.3	165.3	202.3	201	1.3	8	1	
	25	<input type="checkbox"/>	MPS0700-L25C	176.3	197.3	200.3	237.3	236	1.3	8	1	
	30	<input type="checkbox"/>	MPS0700-L30C	211.3	232.3	235.3	272.3	271	1.3	8	1	
	35	<input type="checkbox"/>	MPS0700-L35C	246.3	267.3	269.3	306.3	305	1.3	8	1	
	40	<input type="checkbox"/>	MPS0700-L40C	281.3	301.3	304.3	341.3	340	1.3	8	1	

DC (mm)	Głębokość otworu (L/D)	VP15TF	Numer zamówieniowy	Wymiary (mm)								Typ
				LU	LCF	LH	OAL	LF	PL	DCON		
7.1	3	<input type="checkbox"/>	MPS0710S-DIN-C	30.6	41.3	42.3	79.3	78	1.3	8	1	
	5	<input type="checkbox"/>	MPS0710L-DIN-C	42.6	53.3	54.3	91.3	90	1.3	8	1	
	8	<input type="checkbox"/>	MPS0710-L8C	58.1	84.3	87.3	124.3	123	1.3	8	1	
	10	<input type="checkbox"/>	MPS0710-L10C	72.3	99.3	102.3	139.3	138	1.3	8	1	
	12	<input type="checkbox"/>	MPS0710-L12C	86.5	114.3	117.3	154.3	153	1.3	8	1	
	15	<input type="checkbox"/>	MPS0710-L15C	107.8	136.3	139.3	176.3	175	1.3	8	1	
	20	<input type="checkbox"/>	MPS0710-L20C	143.3	174.3	177.3	214.3	213	1.3	8	1	
	25	<input type="checkbox"/>	MPS0710-L25C	178.8	211.3	214.3	251.3	250	1.3	8	1	
	30	<input type="checkbox"/>	MPS0710-L30C	214.3	249.3	252.3	289.3	288	1.3	8	1	
	35	<input type="checkbox"/>	MPS0710-L35C	249.8	286.3	288.3	325.3	324	1.3	8	1	
	40	<input type="checkbox"/>	MPS0710-L40C	285.3	321.3	323.3	360.3	359	1.3	8	1	
	7.2	3	<input type="checkbox"/>	MPS0720S-DIN-C	30.5	41.3	42.3	79.3	78	1.3	8	1
5		<input type="checkbox"/>	MPS0720L-DIN-C	42.5	53.3	54.3	91.3	90	1.3	8	1	
8		<input type="checkbox"/>	MPS0720-L8C	58.9	84.3	87.3	124.3	123	1.3	8	1	
10		<input type="checkbox"/>	MPS0720-L10C	73.3	99.3	102.3	139.3	138	1.3	8	1	
12		<input type="checkbox"/>	MPS0720-L12C	87.7	114.3	117.3	154.3	153	1.3	8	1	
15		<input type="checkbox"/>	MPS0720-L15C	109.3	136.3	139.3	176.3	175	1.3	8	1	
20		<input type="checkbox"/>	MPS0720-L20C	145.3	174.3	177.3	214.3	213	1.3	8	1	
25		<input type="checkbox"/>	MPS0720-L25C	181.3	211.3	214.3	251.3	250	1.3	8	1	
30		<input type="checkbox"/>	MPS0720-L30C	217.3	249.3	252.3	289.3	288	1.3	8	1	
35		<input type="checkbox"/>	MPS0720-L35C	253.3	286.3	288.3	325.3	324	1.3	8	1	
40		<input type="checkbox"/>	MPS0720-L40C	289.3	321.3	323.3	360.3	359	1.3	8	1	
7.3		3	<input type="checkbox"/>	MPS0730S-DIN-C	30.4	41.3	42.3	79.3	78	1.3	8	1
	5	<input type="checkbox"/>	MPS0730L-DIN-C	42.4	53.3	54.3	91.3	90	1.3	8	1	
	8	<input type="checkbox"/>	MPS0730-L8C	59.7	84.3	87.3	124.3	123	1.3	8	1	
	10	<input type="checkbox"/>	MPS0730-L10C	74.3	99.3	102.3	139.3	138	1.3	8	1	
	12	<input type="checkbox"/>	MPS0730-L12C	88.9	114.3	117.3	154.3	153	1.3	8	1	
	15	<input type="checkbox"/>	MPS0730-L15C	110.8	136.3	139.3	176.3	175	1.3	8	1	
	20	<input type="checkbox"/>	MPS0730-L20C	147.3	174.3	177.3	214.3	213	1.3	8	1	
	25	<input type="checkbox"/>	MPS0730-L25C	183.8	211.3	214.3	251.3	250	1.3	8	1	
	30	<input type="checkbox"/>	MPS0730-L30C	220.3	249.3	252.3	289.3	288	1.3	8	1	
	35	<input type="checkbox"/>	MPS0730-L35C	256.8	286.3	288.3	325.3	324	1.3	8	1	
	40	<input type="checkbox"/>	MPS0730-L40C	293.3	321.3	323.3	360.3	359	1.3	8	1	
	7.4	3	<input type="checkbox"/>	MPS0740S-DIN-C	30.2	41.3	42.3	79.3	78	1.3	8	1
5		<input type="checkbox"/>	MPS0740L-DIN-C	42.2	53.3	54.3	91.3	90	1.3	8	1	
8		<input type="checkbox"/>	MPS0740-L8C	60.5	84.3	87.3	124.3	123	1.3	8	1	
10		<input type="checkbox"/>	MPS0740-L10C	75.3	99.3	102.3	139.3	138	1.3	8	1	
12		<input type="checkbox"/>	MPS0740-L12C	90.1	114.3	117.3	154.3	153	1.3	8	1	
15		<input type="checkbox"/>	MPS0740-L15C	112.3	136.3	139.3	176.3	175	1.3	8	1	
20		<input type="checkbox"/>	MPS0740-L20C	149.3	174.3	177.3	214.3	213	1.3	8	1	
25		<input type="checkbox"/>	MPS0740-L25C	186.3	211.3	214.3	251.3	250	1.3	8	1	
30		<input type="checkbox"/>	MPS0740-L30C	223.3	249.3	252.3	289.3	288	1.3	8	1	
35		<input type="checkbox"/>	MPS0740-L35C	260.3	286.3	288.3	325.3	324	1.3	8	1	
40		<input type="checkbox"/>	MPS0740-L40C	297.3	321.3	323.3	360.3	359	1.3	8	1	
7.5		3	<input type="checkbox"/>	MPS0750S-DIN-C	30.1	41.4	42.4	79.4	78	1.4	8	1
	5	<input type="checkbox"/>	MPS0750L-DIN-C	42.1	53.4	54.4	91.4	90	1.4	8	1	
	8	<input type="checkbox"/>	MPS0750-L8C	61.4	84.4	87.4	124.4	123	1.4	8	1	
	10	<input type="checkbox"/>	MPS0750-L10C	76.4	99.4	102.4	139.4	138	1.4	8	1	
	12	<input type="checkbox"/>	MPS0750-L12C	91.4	114.4	117.4	154.4	153	1.4	8	1	
	15	<input type="checkbox"/>	MPS0750-L15C	113.9	136.4	139.4	176.4	175	1.4	8	1	
	20	<input type="checkbox"/>	MPS0750-L20C	151.4	174.4	177.4	214.4	213	1.4	8	1	
	25	<input type="checkbox"/>	MPS0750-L25C	188.9	211.4	214.4	251.4	250	1.4	8	1	
	30	<input type="checkbox"/>	MPS0750-L30C	226.4	249.4	252.4	289.4	288	1.4	8	1	
	35	<input type="checkbox"/>	MPS0750-L35C	263.9	286.4	288.4	325.4	324	1.4	8	1	
	40	<input type="checkbox"/>	MPS0750-L40C	301.4	321.4	323.4	360.4	359	1.4	8	1	

: Niestandardowy, produkowany na specjalne zamówienie.

M066

DC (mm)	Głębokość otworu (L/D)	VP15TF	Numer zamówieniowy	Wymiary (mm)							Typ
				LU	LCF	LH	OAL	LF	PL	DCON	
7.6	3	<input type="checkbox"/>	MPS0760S-DIN-C	30.0	41.4	42.4	79.4	78	1.4	8	1
	5	<input type="checkbox"/>	MPS0760L-DIN-C	42.0	53.4	54.4	91.4	90	1.4	8	1
	8	<input type="checkbox"/>	MPS0760-L8C	62.2	89.4	92.4	129.4	128	1.4	8	1
	10	<input type="checkbox"/>	MPS0760-L10C	77.4	105.4	108.4	145.4	144	1.4	8	1
	12	<input type="checkbox"/>	MPS0760-L12C	92.6	121.4	124.4	161.4	160	1.4	8	1
	15	<input type="checkbox"/>	MPS0760-L15C	115.4	145.4	148.4	185.4	184	1.4	8	1
	20	<input type="checkbox"/>	MPS0760-L20C	153.4	185.4	188.4	225.4	224	1.4	8	1
	25	<input type="checkbox"/>	MPS0760-L25C	191.4	225.4	228.4	265.4	264	1.4	8	1
	30	<input type="checkbox"/>	MPS0760-L30C	229.4	265.4	268.4	305.4	304	1.4	8	1
	35	<input type="checkbox"/>	MPS0760-L35C	267.4	305.4	307.4	344.4	343	1.4	8	1
	40	<input type="checkbox"/>	MPS0760-L40C	305.4	341.4	342.4	379.4	378	1.4	8	1
7.7	3	<input type="checkbox"/>	MPS0770S-DIN-C	29.9	41.4	42.4	79.4	78	1.4	8	1
	5	<input type="checkbox"/>	MPS0770L-DIN-C	41.9	53.4	54.4	91.4	90	1.4	8	1
	8	<input type="checkbox"/>	MPS0770-L8C	63.0	89.4	92.4	129.4	128	1.4	8	1
	10	<input type="checkbox"/>	MPS0770-L10C	78.4	105.4	108.4	145.4	144	1.4	8	1
	12	<input type="checkbox"/>	MPS0770-L12C	93.8	121.4	124.4	161.4	160	1.4	8	1
	15	<input type="checkbox"/>	MPS0770-L15C	116.9	145.4	148.4	185.4	184	1.4	8	1
	20	<input type="checkbox"/>	MPS0770-L20C	155.4	185.4	188.4	225.4	224	1.4	8	1
	25	<input type="checkbox"/>	MPS0770-L25C	193.9	225.4	228.4	265.4	264	1.4	8	1
	30	<input type="checkbox"/>	MPS0770-L30C	232.4	265.4	268.4	305.4	304	1.4	8	1
	35	<input type="checkbox"/>	MPS0770-L35C	270.9	305.4	307.4	344.4	343	1.4	8	1
	40	<input type="checkbox"/>	MPS0770-L40C	309.4	341.4	342.4	379.4	378	1.4	8	1
7.8	3	<input type="checkbox"/>	MPS0780S-DIN-C	29.7	41.4	42.4	79.4	78	1.4	8	1
	5	<input type="checkbox"/>	MPS0780L-DIN-C	41.7	53.4	54.4	91.4	90	1.4	8	1
	8	<input type="checkbox"/>	MPS0780-L8C	63.8	89.4	92.4	129.4	128	1.4	8	1
	10	<input type="checkbox"/>	MPS0780-L10C	79.4	105.4	108.4	145.4	144	1.4	8	1
	12	<input type="checkbox"/>	MPS0780-L12C	95.0	121.4	124.4	161.4	160	1.4	8	1
	15	<input type="checkbox"/>	MPS0780-L15C	118.4	145.4	148.4	185.4	184	1.4	8	1
	20	<input type="checkbox"/>	MPS0780-L20C	157.4	185.4	188.4	225.4	224	1.4	8	1
	25	<input type="checkbox"/>	MPS0780-L25C	196.4	225.4	228.4	265.4	264	1.4	8	1
	30	<input type="checkbox"/>	MPS0780-L30C	235.4	265.4	268.4	305.4	304	1.4	8	1
	35	<input type="checkbox"/>	MPS0780-L35C	274.4	305.4	307.4	344.4	343	1.4	8	1
	40	<input type="checkbox"/>	MPS0780-L40C	313.4	341.4	342.4	379.4	378	1.4	8	1
7.9	3	<input type="checkbox"/>	MPS0790S-DIN-C	29.6	41.4	42.4	79.4	78	1.4	8	1
	5	<input type="checkbox"/>	MPS0790L-DIN-C	41.6	53.4	54.4	91.4	90	1.4	8	1
	8	<input type="checkbox"/>	MPS0790-L8C	64.6	89.4	92.4	129.4	128	1.4	8	1
	10	<input type="checkbox"/>	MPS0790-L10C	80.4	105.4	108.4	145.4	144	1.4	8	1
	12	<input type="checkbox"/>	MPS0790-L12C	96.2	121.4	124.4	161.4	160	1.4	8	1
	15	<input type="checkbox"/>	MPS0790-L15C	119.9	145.4	148.4	185.4	184	1.4	8	1
	20	<input type="checkbox"/>	MPS0790-L20C	159.4	185.4	188.4	225.4	224	1.4	8	1
	25	<input type="checkbox"/>	MPS0790-L25C	198.9	225.4	228.4	265.4	264	1.4	8	1
	30	<input type="checkbox"/>	MPS0790-L30C	238.4	265.4	268.4	305.4	304	1.4	8	1
	35	<input type="checkbox"/>	MPS0790-L35C	277.9	305.4	307.4	344.4	343	1.4	8	1
	40	<input type="checkbox"/>	MPS0790-L40C	317.4	341.4	342.4	379.4	378	1.4	8	1
8.0	3	<input type="checkbox"/>	MPS0800S-DIN-C	29.5	41.5	42.5	79.5	78	1.5	8	2
	5	<input type="checkbox"/>	MPS0800L-DIN-C	41.5	53.5	54.5	91.5	90	1.5	8	2
	8	<input type="checkbox"/>	MPS0800-L8C	65.5	89.5	92.5	129.5	128	1.5	8	2
	10	<input type="checkbox"/>	MPS0800-L10C	81.5	105.5	108.5	145.5	144	1.5	8	2
	12	<input type="checkbox"/>	MPS0800-L12C	97.5	121.5	124.5	161.5	160	1.5	8	2
	15	<input type="checkbox"/>	MPS0800-L15C	121.5	145.5	148.5	185.5	184	1.5	8	2
	20	<input type="checkbox"/>	MPS0800-L20C	161.5	185.5	188.5	225.5	224	1.5	8	2
	25	<input type="checkbox"/>	MPS0800-L25C	201.5	225.5	228.5	265.5	264	1.5	8	2
	30	<input type="checkbox"/>	MPS0800-L30C	241.5	265.5	268.5	305.5	304	1.5	8	2
	35	<input type="checkbox"/>	MPS0800-L35C	281.5	305.5	307.5	344.5	343	1.5	8	2
	40	<input type="checkbox"/>	MPS0800-L40C	321.5	341.5	342.5	379.5	378	1.5	8	2

DC (mm)	Głębokość otworu (L/D)	VP15TF	Numer zamówieniowy	Wymiary (mm)							Typ
				LU	LCF	LH	OAL	LF	PL	DCON	
8.05	3	<input type="checkbox"/>	MPS0805S-DIN-C	34.4	46.5	47.5	88.5	87	1.5	10	1
	5	<input type="checkbox"/>	MPS0805L-DIN-C	48.4	60.5	61.5	102.5	101	1.5	10	1
8.1	3	<input type="checkbox"/>	MPS0810S-DIN-C	34.3	46.5	47.5	88.5	87	1.5	10	1
	5	<input type="checkbox"/>	MPS0810L-DIN-C	48.3	60.5	61.5	102.5	101	1.5	10	1
	8	<input type="checkbox"/>	MPS0810-L8C	66.3	95.5	98.5	139.5	138	1.5	10	1
	10	<input type="checkbox"/>	MPS0810-L10C	82.5	112.5	115.5	156.5	155	1.5	10	1
	12	<input type="checkbox"/>	MPS0810-L12C	98.7	129.5	132.5	173.5	172	1.5	10	1
	15	<input type="checkbox"/>	MPS0810-L15C	123.0	154.5	157.5	198.5	197	1.5	10	1
	20	<input type="checkbox"/>	MPS0810-L20C	163.5	197.5	200.5	241.5	240	1.5	10	1
	25	<input type="checkbox"/>	MPS0810-L25C	204.0	239.5	242.5	283.5	282	1.5	10	1
	30	<input type="checkbox"/>	MPS0810-L30C	244.5	281.5	284.5	325.5	324	1.5	10	1
	35	<input type="checkbox"/>	MPS0810-L35C	285.0	324.5	326.5	367.5	366	1.5	10	1
	40	<input type="checkbox"/>	MPS0810-L40C	325.5	366.5	370.5	411.5	410	1.5	10	1
8.2	3	<input type="checkbox"/>	MPS0820S-DIN-C	34.2	46.5	47.5	88.5	87	1.5	10	1
	5	<input type="checkbox"/>	MPS0820L-DIN-C	48.2	60.5	61.5	102.5	101	1.5	10	1
	8	<input type="checkbox"/>	MPS0820-L8C	67.1	95.5	98.5	139.5	138	1.5	10	1
	10	<input type="checkbox"/>	MPS0820-L10C	83.5	112.5	115.5	156.5	155	1.5	10	1
	12	<input type="checkbox"/>	MPS0820-L12C	99.9	129.5	132.5	173.5	172	1.5	10	1
	15	<input type="checkbox"/>	MPS0820-L15C	124.5	154.5	157.5	198.5	197	1.5	10	1
	20	<input type="checkbox"/>	MPS0820-L20C	165.5	197.5	200.5	241.5	240	1.5	10	1
	25	<input type="checkbox"/>	MPS0820-L25C	206.5	239.5	242.5	283.5	282	1.5	10	1
	30	<input type="checkbox"/>	MPS0820-L30C	247.5	281.5	284.5	325.5	324	1.5	10	1
	35	<input type="checkbox"/>	MPS0820-L35C	288.5	324.5	326.5	367.5	366	1.5	10	1
	40	<input type="checkbox"/>	MPS0820-L40C	329.5	366.5	370.5	411.5	410	1.5	10	1
8.3	3	<input type="checkbox"/>	MPS0830S-DIN-C	34.1	46.5	47.5	88.5	87	1.5	10	1
	5	<input type="checkbox"/>	MPS0830L-DIN-C	48.1	60.5	61.5	102.5	101	1.5	10	1
	8	<input type="checkbox"/>	MPS0830-L8C	67.9	95.5	98.5	139.5	138	1.5	10	1
	10	<input type="checkbox"/>	MPS0830-L10C	84.5	112.5	115.5	156.5	155	1.5	10	1
	12	<input type="checkbox"/>	MPS0830-L12C	101.1	129.5	132.5	173.5	172	1.5	10	1
	15	<input type="checkbox"/>	MPS0830-L15C	126.0	154.5	157.5	198.5	197	1.5	10	1
	20	<input type="checkbox"/>	MPS0830-L20C	167.5	197.5	200.5	241.5	240	1.5	10	1
	25	<input type="checkbox"/>	MPS0830-L25C	209.0	239.5	242.5	283.5	282	1.5	10	1
	30	<input type="checkbox"/>	MPS0830-L30C	250.5	281.5	284.5	325.5	324	1.5	10	1
	35	<input type="checkbox"/>	MPS0830-L35C	292.0	324.5	326.5	367.5	366	1.5	10	1
	40	<input type="checkbox"/>	MPS0830-L40C	333.5	366.5	370.5	411.5	410	1.5	10	1
8.4	3	<input type="checkbox"/>	MPS0840S-DIN-C	33.9	46.5	47.5	88.5	87	1.5	10	1
	5	<input type="checkbox"/>	MPS0840L-DIN-C	47.9	60.5	61.5	102.5	101	1.5	10	1
	8	<input type="checkbox"/>	MPS0840-L8C	68.7	95.5	98.5	139.5	138	1.5	10	1
	10	<input type="checkbox"/>	MPS0840-L10C	85.5	112.5	115.5	156.5	155	1.5	10	1
	12	<input type="checkbox"/>	MPS0840-L12C	102.3	129.5	132.5	173.5	172	1.5	10	1
	15	<input type="checkbox"/>	MPS0840-L15C	127.5	154.5	157.5	198.5	197	1.5	10	1
	20	<input type="checkbox"/>	MPS0840-L20C	169.5	197.5	200.5	241.5	240	1.5	10	1
	25	<input type="checkbox"/>	MPS0840-L25C	211.5	239.5	242.5	283.5	282	1.5	10	1
	30	<input type="checkbox"/>	MPS0840-L30C	253.5	281.5	284.5	325.5	324	1.5	10	1
	35	<input type="checkbox"/>	MPS0840-L35C	295.5	324.5	326.5	367.5	366	1.5	10	1
	40	<input type="checkbox"/>	MPS0840-L40C	337.5	366.5	370.5	411.5	410	1.5	10	1
8.5	3	<input type="checkbox"/>	MPS0850S-DIN-C	33.8	46.5	47.5	88.5	87	1.5	10	1
	5	<input type="checkbox"/>	MPS0850L-DIN-C	47.8	60.5	61.5	102.5	101	1.5	10	1
	8	<input type="checkbox"/>	MPS0850-L8C	69.5	95.5	98.5	139.5	138	1.5	10	1
	10	<input type="checkbox"/>	MPS0850-L10C	86.5	112.5	115.5	156.5	155	1.5	10	1
	12	<input type="checkbox"/>	MPS0850-L12C	103.5	129.5	132.5	173.5	172	1.5	10	1
	15	<input type="checkbox"/>	MPS0850-L15C	129.0	154.5	157.5	198.5	197	1.5	10	1
	20	<input type="checkbox"/>	MPS0850-L20C	171.5	197.5	200.5	241.5	240	1.5	10	1
	25	<input type="checkbox"/>	MPS0850-L25C	214.0	239.5	242.5	283.5	282	1.5	10	1
	30	<input type="checkbox"/>	MPS0850-L30C	256.5	281.5	284.5	325.5	324	1.5	10	1
	35	<input type="checkbox"/>	MPS0850-L35C	299.0	324.5	326.5	367.5	366	1.5	10	1
	40	<input type="checkbox"/>	MPS0850-L40C	341.5	366.5	370.5	411.5	410	1.5	10	1

WIERCENIE (WIERTŁA PEŁNOWĘGLIKOWE)

MPS

Wiertła z podwójną łysinką
i wiertła super długie

WĘGLIKI
SPIEKANE

WIERCENIE

M

DC (mm)	Głębokość otworu (L/D)	VP15TF	Numer zamówieniowy	Wymiary (mm)							Typ
				LU	LCF	LH	OAL	LF	PL	DCON	
8.6	3	<input type="checkbox"/>	MPS0860S-DIN-C	33.7	46.6	47.6	88.6	87	1.6	10	1
	5	<input type="checkbox"/>	MPS0860L-DIN-C	47.7	60.6	61.6	102.6	101	1.6	10	1
	8	<input type="checkbox"/>	MPS0860-L8C	70.4	100.6	103.6	144.6	143	1.6	10	1
	10	<input type="checkbox"/>	MPS0860-L10C	87.6	118.6	121.6	162.6	161	1.6	10	1
	12	<input type="checkbox"/>	MPS0860-L12C	104.8	136.6	139.6	180.6	179	1.6	10	1
	15	<input type="checkbox"/>	MPS0860-L15C	130.6	163.6	166.6	207.6	206	1.6	10	1
	20	<input type="checkbox"/>	MPS0860-L20C	173.6	208.6	211.6	252.6	251	1.6	10	1
	25	<input type="checkbox"/>	MPS0860-L25C	216.6	253.6	256.6	297.6	296	1.6	10	1
	30	<input type="checkbox"/>	MPS0860-L30C	259.6	297.6	300.6	341.6	340	1.6	10	1
	35	<input type="checkbox"/>	MPS0860-L35C	302.6	343.6	345.6	386.6	385	1.6	10	1
40	<input type="checkbox"/>	MPS0860-L40C	345.6	391.6	394.6	435.6	434	1.6	10	1	
8.7	3	<input type="checkbox"/>	MPS0870S-DIN-C	33.5	46.6	47.6	88.6	87	1.6	10	1
	5	<input type="checkbox"/>	MPS0870L-DIN-C	47.5	60.6	61.6	102.6	101	1.6	10	1
	8	<input type="checkbox"/>	MPS0870-L8C	71.2	100.6	103.6	144.6	143	1.6	10	1
	10	<input type="checkbox"/>	MPS0870-L10C	88.6	118.6	121.6	162.6	161	1.6	10	1
	12	<input type="checkbox"/>	MPS0870-L12C	106.0	136.6	139.6	180.6	179	1.6	10	1
	15	<input type="checkbox"/>	MPS0870-L15C	132.1	163.6	166.6	207.6	206	1.6	10	1
	20	<input type="checkbox"/>	MPS0870-L20C	175.6	208.6	211.6	252.6	251	1.6	10	1
	25	<input type="checkbox"/>	MPS0870-L25C	219.1	253.6	256.6	297.6	296	1.6	10	1
	30	<input type="checkbox"/>	MPS0870-L30C	262.6	297.6	300.6	341.6	340	1.6	10	1
	35	<input type="checkbox"/>	MPS0870-L35C	306.1	343.6	345.6	386.6	385	1.6	10	1
40	<input type="checkbox"/>	MPS0870-L40C	349.6	391.6	394.6	435.6	434	1.6	10	1	
8.8	3	<input type="checkbox"/>	MPS0880S-DIN-C	33.4	46.6	47.6	88.6	87	1.6	10	1
	5	<input type="checkbox"/>	MPS0880L-DIN-C	47.4	60.6	61.6	102.6	101	1.6	10	1
	8	<input type="checkbox"/>	MPS0880-L8C	72.0	100.6	103.6	144.6	143	1.6	10	1
	10	<input type="checkbox"/>	MPS0880-L10C	89.6	118.6	121.6	162.6	161	1.6	10	1
	12	<input type="checkbox"/>	MPS0880-L12C	107.2	136.6	139.6	180.6	179	1.6	10	1
	15	<input type="checkbox"/>	MPS0880-L15C	133.6	163.6	166.6	207.6	206	1.6	10	1
	20	<input type="checkbox"/>	MPS0880-L20C	177.6	208.6	211.6	252.6	251	1.6	10	1
	25	<input type="checkbox"/>	MPS0880-L25C	221.6	253.6	256.6	297.6	296	1.6	10	1
	30	<input type="checkbox"/>	MPS0880-L30C	265.6	297.6	300.6	341.6	340	1.6	10	1
	35	<input type="checkbox"/>	MPS0880-L35C	309.6	343.6	345.6	386.6	385	1.6	10	1
40	<input type="checkbox"/>	MPS0880-L40C	353.6	391.6	394.6	435.6	434	1.6	10	1	
8.9	3	<input type="checkbox"/>	MPS0890S-DIN-C	33.3	46.6	47.6	88.6	87	1.6	10	1
	5	<input type="checkbox"/>	MPS0890L-DIN-C	47.3	60.6	61.6	102.6	101	1.6	10	1
	8	<input type="checkbox"/>	MPS0890-L8C	72.8	100.6	103.6	144.6	143	1.6	10	1
	10	<input type="checkbox"/>	MPS0890-L10C	90.6	118.6	121.6	162.6	161	1.6	10	1
	12	<input type="checkbox"/>	MPS0890-L12C	108.4	136.6	139.6	180.6	179	1.6	10	1
	15	<input type="checkbox"/>	MPS0890-L15C	135.1	163.6	166.6	207.6	206	1.6	10	1
	20	<input type="checkbox"/>	MPS0890-L20C	179.6	208.6	211.6	252.6	251	1.6	10	1
	25	<input type="checkbox"/>	MPS0890-L25C	224.1	253.6	256.6	297.6	296	1.6	10	1
	30	<input type="checkbox"/>	MPS0890-L30C	268.6	297.6	300.6	341.6	340	1.6	10	1
	35	<input type="checkbox"/>	MPS0890-L35C	313.1	343.6	345.6	386.6	385	1.6	10	1
40	<input type="checkbox"/>	MPS0890-L40C	357.6	391.6	394.6	435.6	434	1.6	10	1	
9.0	3	<input type="checkbox"/>	MPS0900S-DIN-C	33.1	46.6	47.6	88.6	87	1.6	10	1
	5	<input type="checkbox"/>	MPS0900L-DIN-C	47.1	60.6	61.6	102.6	101	1.6	10	1
	8	<input type="checkbox"/>	MPS0900-L8C	73.6	100.6	103.6	144.6	143	1.6	10	1
	10	<input type="checkbox"/>	MPS0900-L10C	91.6	118.6	121.6	162.6	161	1.6	10	1
	12	<input type="checkbox"/>	MPS0900-L12C	109.6	136.6	139.6	180.6	179	1.6	10	1
	15	<input type="checkbox"/>	MPS0900-L15C	136.6	163.6	166.6	207.6	206	1.6	10	1
	20	<input type="checkbox"/>	MPS0900-L20C	181.6	208.6	211.6	252.6	251	1.6	10	1
	25	<input type="checkbox"/>	MPS0900-L25C	226.6	253.6	256.6	297.6	296	1.6	10	1
	30	<input type="checkbox"/>	MPS0900-L30C	271.6	297.6	300.6	341.6	340	1.6	10	1
	35	<input type="checkbox"/>	MPS0900-L35C	316.6	343.6	345.6	386.6	385	1.6	10	1
40	<input type="checkbox"/>	MPS0900-L40C	361.6	391.6	394.6	435.6	434	1.6	10	1	

DC (mm)	Głębokość otworu (L/D)	VP15TF	Numer zamówieniowy	Wymiary (mm)							Typ
				LU	LCF	LH	OAL	LF	PL	DCON	
9.1	3	<input type="checkbox"/>	MPS0910S-DIN-C	33.0	46.7	47.7	88.7	87	1.7	10	1
	5	<input type="checkbox"/>	MPS0910L-DIN-C	47.0	60.7	61.7	102.7	101	1.7	10	1
	8	<input type="checkbox"/>	MPS0910-L8C	74.5	106.7	109.7	150.7	149	1.7	10	1
	10	<input type="checkbox"/>	MPS0910-L10C	92.7	125.7	128.7	169.7	168	1.7	10	1
	12	<input type="checkbox"/>	MPS0910-L12C	110.9	144.7	147.7	188.7	187	1.7	10	1
	15	<input type="checkbox"/>	MPS0910-L15C	138.2	172.7	175.7	216.7	215	1.7	10	1
	20	<input type="checkbox"/>	MPS0910-L20C	183.7	220.7	223.7	264.7	263	1.7	10	1
	25	<input type="checkbox"/>	MPS0910-L25C	229.2	267.7	270.7	311.7	310	1.7	10	1
	30	<input type="checkbox"/>	MPS0910-L30C	274.7	315.7	318.7	359.7	358	1.7	10	1
	35	<input type="checkbox"/>	MPS0910-L35C	320.2	362.7	364.7	405.7	404	1.7	10	1
9.2	3	<input type="checkbox"/>	MPS0920S-DIN-C	32.9	46.7	47.7	88.7	87	1.7	10	1
	5	<input type="checkbox"/>	MPS0920L-DIN-C	46.9	60.7	61.7	102.7	101	1.7	10	1
	8	<input type="checkbox"/>	MPS0920-L8C	75.3	106.7	109.7	150.7	149	1.7	10	1
	10	<input type="checkbox"/>	MPS0920-L10C	93.7	125.7	128.7	169.7	168	1.7	10	1
	12	<input type="checkbox"/>	MPS0920-L12C	112.1	144.7	147.7	188.7	187	1.7	10	1
	15	<input type="checkbox"/>	MPS0920-L15C	139.7	172.7	175.7	216.7	215	1.7	10	1
	20	<input type="checkbox"/>	MPS0920-L20C	185.7	220.7	223.7	264.7	263	1.7	10	1
	25	<input type="checkbox"/>	MPS0920-L25C	231.7	267.7	270.7	311.7	310	1.7	10	1
	30	<input type="checkbox"/>	MPS0920-L30C	277.7	315.7	318.7	359.7	358	1.7	10	1
	35	<input type="checkbox"/>	MPS0920-L35C	323.7	362.7	364.7	405.7	404	1.7	10	1
9.3	3	<input type="checkbox"/>	MPS0930S-DIN-C	32.7	46.7	47.7	88.7	87	1.7	10	1
	5	<input type="checkbox"/>	MPS0930L-DIN-C	46.7	60.7	61.7	102.7	101	1.7	10	1
	8	<input type="checkbox"/>	MPS0930-L8C	76.1	106.7	109.7	150.7	149	1.7	10	1
	10	<input type="checkbox"/>	MPS0930-L10C	94.7	125.7	128.7	169.7	168	1.7	10	1
	12	<input type="checkbox"/>	MPS0930-L12C	113.3	144.7	147.7	188.7	187	1.7	10	1
	15	<input type="checkbox"/>	MPS0930-L15C	141.2	172.7	175.7	216.7	215	1.7	10	1
	20	<input type="checkbox"/>	MPS0930-L20C	187.7	220.7	223.7	264.7	263	1.7	10	1
	25	<input type="checkbox"/>	MPS0930-L25C	234.2	267.7	270.7	311.7	310	1.7	10	1
	30	<input type="checkbox"/>	MPS0930-L30C	280.7	315.7	318.7	359.7	358	1.7	10	1
	35	<input type="checkbox"/>	MPS0930-L35C	327.2	362.7	364.7	405.7	404	1.7	10	1
9.4	3	<input type="checkbox"/>	MPS0940S-DIN-C	32.6	46.7	47.7	88.7	87	1.7	10	1
	5	<input type="checkbox"/>	MPS0940L-DIN-C	46.6	60.7	61.7	102.7	101	1.7	10	1
	8	<input type="checkbox"/>	MPS0940-L8C	76.9	106.7	109.7	150.7	149	1.7	10	1
	10	<input type="checkbox"/>	MPS0940-L10C	95.7	125.7	128.7	169.7	168	1.7	10	1
	12	<input type="checkbox"/>	MPS0940-L12C	114.5	144.7	147.7	188.7	187	1.7	10	1
	15	<input type="checkbox"/>	MPS0940-L15C	142.7	172.7	175.7	216.7	215	1.7	10	1
	20	<input type="checkbox"/>	MPS0940-L20C	189.7	220.7	223.7	264.7	263	1.7	10	1
	25	<input type="checkbox"/>	MPS0940-L25C	236.7	267.7	270.7	311.7	310	1.7	10	1
	30	<input type="checkbox"/>	MPS0940-L30C	283.7	315.7	318.7	359.7	358	1.7	10	1
	35	<input type="checkbox"/>	MPS0940-L35C	330.7	362.7	364.7	405.7	404	1.7	10	1
9.5	3	<input type="checkbox"/>	MPS0950S-DIN-C	32.5	46.7	47.7	88.7	87	1.7	10	1
	5	<input type="checkbox"/>	MPS0950L-DIN-C	46.5	60.7	61.7	102.7	101	1.7	10	1
	8	<input type="checkbox"/>	MPS0950-L8C	77.7	106.7	109.7	150.7	149	1.7	10	1
	10	<input type="checkbox"/>	MPS0950-L10C	96.7	125.7	128.7	169.7	168	1.7	10	1
	12	<input type="checkbox"/>	MPS0950-L12C	115.7	144.7	147.7	188.7	187	1.7	10	1
	15	<input type="checkbox"/>	MPS0950-L15C	144.2	172.7	175.7	216.7	215	1.7	10	1
	20	<input type="checkbox"/>	MPS0950-L20C	191.7	220.7	223.7	264.7	263	1.7	10	1
	25	<input type="checkbox"/>	MPS0950-L25C	239.2	267.7	270.7	311.7	310	1.7	10	1
	30	<input type="checkbox"/>	MPS0950-L30C	286.7	315.7	318.7	359.7	358	1.7	10	1
	35	<input type="checkbox"/>	MPS0950-L35C	334.2	362.7	364.7	405.7	404	1.7	10	1
9.6	3	<input type="checkbox"/>	MPS0960S-DIN-C	32.3	46.7	47.7	88.7	87	1.7	10	1
	5	<input type="checkbox"/>	MPS0960L-DIN-C	46.3	60.7	61.7	102.7	101	1.7	10	1
	8	<input type="checkbox"/>	MPS0960-L8C	78.5	111.7	114.7	155.7	154	1.7	10	1
	10	<input type="checkbox"/>	MPS0960-L10C	97.7	131.7	134.7	175.7	174	1.7	10	1
	12	<input type="checkbox"/>	MPS0960-L12C	116.9	151.7	154.7	195.7	194	1.7	10	1
	15	<input type="checkbox"/>	MPS0960-L15C	145.7	181.7	184.7	225.7	224	1.7	10	1

☐ : Niestandardowy, produkowany na specjalne zamówienie.

DC (mm)	Głębokość otworu (L/D)	VP15TF	Numer zamówieniowy	Wymiary (mm)							Typ
				LU	LCF	LH	OAL	LF	PL	DCON	
9.6	20	<input type="checkbox"/>	MPS0960-L20C	193.7	231.7	234.7	275.7	274	1.7	10	1
	25	<input type="checkbox"/>	MPS0960-L25C	241.7	281.7	284.7	325.7	324	1.7	10	1
	30	<input type="checkbox"/>	MPS0960-L30C	289.7	331.7	334.7	375.7	374	1.7	10	1
	35	<input type="checkbox"/>	MPS0960-L35C	337.7	381.7	383.7	424.7	423	1.7	10	1
9.7	3	<input type="checkbox"/>	MPS0970S-DIN-C	32.2	46.8	47.8	88.8	87	1.8	10	1
	5	<input type="checkbox"/>	MPS0970L-DIN-C	46.2	60.8	61.8	102.8	101	1.8	10	1
	8	<input type="checkbox"/>	MPS0970-L8C	79.4	111.8	114.8	155.8	154	1.8	10	1
	10	<input type="checkbox"/>	MPS0970-L10C	98.8	131.8	134.8	175.8	174	1.8	10	1
	12	<input type="checkbox"/>	MPS0970-L12C	118.2	151.8	154.8	195.8	194	1.8	10	1
	15	<input type="checkbox"/>	MPS0970-L15C	147.3	181.8	184.8	225.8	224	1.8	10	1
	20	<input type="checkbox"/>	MPS0970-L20C	195.8	231.8	234.8	275.8	274	1.8	10	1
	25	<input type="checkbox"/>	MPS0970-L25C	244.3	281.8	284.8	325.8	324	1.8	10	1
	30	<input type="checkbox"/>	MPS0970-L30C	292.8	331.8	334.8	375.8	374	1.8	10	1
35	<input type="checkbox"/>	MPS0970-L35C	341.3	381.8	383.8	424.8	423	1.8	10	1	
9.8	3	<input type="checkbox"/>	MPS0980S-DIN-C	32.1	46.8	47.8	88.8	87	1.8	10	1
	5	<input type="checkbox"/>	MPS0980L-DIN-C	46.1	60.8	61.8	102.8	101	1.8	10	1
	8	<input type="checkbox"/>	MPS0980-L8C	80.2	111.8	114.8	155.8	154	1.8	10	1
	10	<input type="checkbox"/>	MPS0980-L10C	99.8	131.8	134.8	175.8	174	1.8	10	1
	12	<input type="checkbox"/>	MPS0980-L12C	119.4	151.8	154.8	195.8	194	1.8	10	1
	15	<input type="checkbox"/>	MPS0980-L15C	148.8	181.8	184.8	225.8	224	1.8	10	1
	20	<input type="checkbox"/>	MPS0980-L20C	197.8	231.8	234.8	275.8	274	1.8	10	1
	25	<input type="checkbox"/>	MPS0980-L25C	246.8	281.8	284.8	325.8	324	1.8	10	1
	30	<input type="checkbox"/>	MPS0980-L30C	295.8	331.8	334.8	375.8	374	1.8	10	1
35	<input type="checkbox"/>	MPS0980-L35C	344.8	381.8	383.8	424.8	423	1.8	10	1	
9.9	3	<input type="checkbox"/>	MPS0990S-DIN-C	32.0	46.8	47.8	88.8	87	1.8	10	1
	5	<input type="checkbox"/>	MPS0990L-DIN-C	46.0	60.8	61.8	102.8	101	1.8	10	1
	8	<input type="checkbox"/>	MPS0990-L8C	81.0	111.8	114.8	155.8	154	1.8	10	1
	10	<input type="checkbox"/>	MPS0990-L10C	100.8	131.8	134.8	175.8	174	1.8	10	1
	12	<input type="checkbox"/>	MPS0990-L12C	120.6	151.8	154.8	195.8	194	1.8	10	1
	15	<input type="checkbox"/>	MPS0990-L15C	150.3	181.8	184.8	225.8	224	1.8	10	1
	20	<input type="checkbox"/>	MPS0990-L20C	199.8	231.8	234.8	275.8	274	1.8	10	1
	25	<input type="checkbox"/>	MPS0990-L25C	249.3	281.8	284.8	325.8	324	1.8	10	1
	30	<input type="checkbox"/>	MPS0990-L30C	298.8	331.8	334.8	375.8	374	1.8	10	1
35	<input type="checkbox"/>	MPS0990-L35C	348.3	381.8	383.8	424.8	423	1.8	10	1	
10.0	3	<input type="checkbox"/>	MPS1000S-DIN-C	31.8	46.8	47.8	88.8	87	1.8	10	2
	5	<input type="checkbox"/>	MPS1000L-DIN-C	45.8	60.8	61.8	102.8	101	1.8	10	2
	8	<input type="checkbox"/>	MPS1000-L8C	81.8	111.8	114.8	155.8	154	1.8	10	2
	10	<input type="checkbox"/>	MPS1000-L10C	101.8	131.8	134.8	175.8	174	1.8	10	2
	12	<input type="checkbox"/>	MPS1000-L12C	121.8	151.8	154.8	195.8	194	1.8	10	2
	15	<input type="checkbox"/>	MPS1000-L15C	151.8	181.8	184.8	225.8	224	1.8	10	2
	20	<input type="checkbox"/>	MPS1000-L20C	201.8	231.8	234.8	275.8	274	1.8	10	2
	25	<input type="checkbox"/>	MPS1000-L25C	251.8	281.8	284.8	325.8	324	1.8	10	2
	30	<input type="checkbox"/>	MPS1000-L30C	301.8	331.8	334.8	375.8	374	1.8	10	2
35	<input type="checkbox"/>	MPS1000-L35C	351.8	381.8	383.8	424.8	423	1.8	10	2	
10.05	3	<input type="checkbox"/>	MPS1005S-DIN-C	39.8	54.8	55.8	101.8	100	1.8	12	1
	5	<input type="checkbox"/>	MPS1005L-DIN-C	55.8	70.8	71.8	117.8	116	1.8	12	1
10.1	3	<input type="checkbox"/>	MPS1010S-DIN-C	39.7	54.8	55.8	101.8	100	1.8	12	1
	5	<input type="checkbox"/>	MPS1010L-DIN-C	55.7	70.8	71.8	117.8	116	1.8	12	1
	8	<input type="checkbox"/>	MPS1010-L8C	82.6	117.8	120.8	166.8	165	1.8	12	1
	10	<input type="checkbox"/>	MPS1010-L10C	102.8	138.8	141.8	187.8	186	1.8	12	1
	12	<input type="checkbox"/>	MPS1010-L12C	123.0	159.8	162.8	208.8	207	1.8	12	1
	15	<input type="checkbox"/>	MPS1010-L15C	153.3	190.8	193.8	239.8	238	1.8	12	1
10.1	20	<input type="checkbox"/>	MPS1010-L20C	203.8	243.8	246.8	292.8	291	1.8	12	1
	25	<input type="checkbox"/>	MPS1010-L25C	254.3	295.8	298.8	344.8	343	1.8	12	1

DC (mm)	Głębokość otworu (L/D)	VP15TF	Numer zamówieniowy	Wymiary (mm)							Typ
				LU	LCF	LH	OAL	LF	PL	DCON	
10.2	3	<input type="checkbox"/>	MPS1020S-DIN-C	39.6	54.9	55.9	101.9	100	1.9	12	1
	5	<input type="checkbox"/>	MPS1020L-DIN-C	55.6	70.9	71.9	117.9	116	1.9	12	1
	8	<input type="checkbox"/>	MPS1020-L8C	83.5	117.9	120.9	166.9	165	1.9	12	1
	10	<input type="checkbox"/>	MPS1020-L10C	103.9	138.9	141.9	187.9	186	1.9	12	1
	12	<input type="checkbox"/>	MPS1020-L12C	124.3	159.9	162.9	208.9	207	1.9	12	1
	15	<input type="checkbox"/>	MPS1020-L15C	154.9	190.9	193.9	239.9	238	1.9	12	1
10.3	20	<input type="checkbox"/>	MPS1020-L20C	205.9	243.9	246.9	292.9	291	1.9	12	1
	25	<input type="checkbox"/>	MPS1020-L25C	256.9	295.9	298.9	344.9	343	1.9	12	1
	3	<input type="checkbox"/>	MPS1030S-DIN-C	39.4	54.9	55.9	101.9	100	1.9	12	1
	5	<input type="checkbox"/>	MPS1030L-DIN-C	55.4	70.9	71.9	117.9	116	1.9	12	1
	8	<input type="checkbox"/>	MPS1030-L8C	84.3	117.9	120.9	166.9	165	1.9	12	1
	10	<input type="checkbox"/>	MPS1030-L10C	104.9	138.9	141.9	187.9	186	1.9	12	1
10.4	12	<input type="checkbox"/>	MPS1030-L12C	125.5	159.9	162.9	208.9	207	1.9	12	1
	15	<input type="checkbox"/>	MPS1030-L15C	156.4	190.9	193.9	239.9	238	1.9	12	1
	20	<input type="checkbox"/>	MPS1030-L20C	207.9	243.9	246.9	292.9	291	1.9	12	1
	25	<input type="checkbox"/>	MPS1030-L25C	259.4	295.9	298.9	344.9	343	1.9	12	1
	3	<input type="checkbox"/>	MPS1040S-DIN-C	39.3	54.9	55.9	101.9	100	1.9	12	1
	5	<input type="checkbox"/>	MPS1040L-DIN-C	55.3	70.9	71.9	117.9	116	1.9	12	1
10.5	8	<input type="checkbox"/>	MPS1040-L8C	85.1	117.9	120.9	166.9	165	1.9	12	1
	10	<input type="checkbox"/>	MPS1040-L10C	105.9	138.9	141.9	187.9	186	1.9	12	1
	12	<input type="checkbox"/>	MPS1040-L12C	126.7	159.9	162.9	208.9	207	1.9	12	1
	15	<input type="checkbox"/>	MPS1040-L15C	157.9	190.9	193.9	239.9	238	1.9	12	1
	20	<input type="checkbox"/>	MPS1040-L20C	209.9	243.9	246.9	292.9	291	1.9	12	1
	25	<input type="checkbox"/>	MPS1040-L25C	261.9	295.9	298.9	344.9	343	1.9	12	1
10.6	3	<input type="checkbox"/>	MPS1050S-DIN-C	39.2	54.9	55.9	101.9	100	1.9	12	1
	5	<input type="checkbox"/>	MPS1050L-DIN-C	55.2	70.9	71.9	117.9	116	1.9	12	1
	8	<input type="checkbox"/>	MPS1050-L8C	85.9	117.9	120.9	166.9	165	1.9	12	1
	10	<input type="checkbox"/>	MPS1050-L10C	106.9	138.9	141.9	187.9	186	1.9	12	1
	12	<input type="checkbox"/>	MPS1050-L12C	127.9	159.9	162.9	208.9	207	1.9	12	1
	15	<input type="checkbox"/>	MPS1050-L15C	159.4	190.9	193.9	239.9	238	1.9	12	1
10.7	20	<input type="checkbox"/>	MPS1050-L20C	211.9	243.9	246.9	292.9	291	1.9	12	1
	25	<input type="checkbox"/>	MPS1050-L25C	264.4	295.9	298.9	344.9	343	1.9	12	1
	3	<input type="checkbox"/>	MPS1060S-DIN-C	39.0	54.9	55.9	101.9	100	1.9	12	1
	5	<input type="checkbox"/>	MPS1060L-DIN-C	55.0	70.9	71.9	117.9	116	1.9	12	1
	8	<input type="checkbox"/>	MPS1060-L8C	86.7	122.9	125.9	171.9	170	1.9	12	1
	10	<input type="checkbox"/>	MPS1060-L10C	107.9	144.9	147.9	193.9	192	1.9	12	1
10.8	12	<input type="checkbox"/>	MPS1060-L12C	129.1	166.9	169.9	215.9	214	1.9	12	1
	15	<input type="checkbox"/>	MPS1060-L15C	160.9	197.9	202.9	248.9	247	1.9	12	1
	20	<input type="checkbox"/>	MPS1060-L20C	213.9	254.9	257.9	303.9	302	1.9	12	1
	25	<input type="checkbox"/>	MPS1060-L25C	266.9	309.9	312.9	358.9	357	1.9	12	1
	3	<input type="checkbox"/>	MPS1070S-DIN-C	38.9	54.9	55.9	101.9	100	1.9	12	1
	5	<input type="checkbox"/>	MPS1070L-DIN-C	54.9	70.9	71.9	117.9	116	1.9	12	1
10.9	8	<input type="checkbox"/>	MPS1070-L8C	87.5	122.9	125.9	171.9	170	1.9	12	1
	10	<input type="checkbox"/>	MPS1070-L10C	108.9	144.9	147.9	193.9	192	1.9	12	1
	12	<input type="checkbox"/>	MPS1070-L12C	130.3	166.9	169.9	215.9	214	1.9	12	1
	15	<input type="checkbox"/>	MPS1070-L15C	162.4	197.9	202.9	248.9	247	1.9	12	1
	20	<input type="checkbox"/>	MPS1070-L20C	215.9	254.9	257.9	303.9	302	1.9	12	1
	25	<input type="checkbox"/>	MPS1070-L25C	269.4	309.9	312.9	358.9	357	1.9	12	1
10.10	3	<input type="checkbox"/>	MPS1080S-DIN-C	38.8	55.0	56.0	102.0	100	2.0	12	1
	5	<input type="checkbox"/>	MPS1080L-DIN-C	54.8	71.0	72.0	118.0	116	2.0	12	1
	8	<input type="checkbox"/>	MPS1080-L8C	88.4	123.0	126.0	172.0	170	2.0	12	1
	10	<input type="checkbox"/>	MPS1080-L10C	110.0	145.0	148.0	194.0	192	2.0	12	1
	12	<input type="checkbox"/>	MPS1080-L12C	131.6	167.0	170.0	216.0	214	2.0	12	1
	15	<input type="checkbox"/>	MPS1080-L15C	164.0	198.0	203.0	249.0	247	2.0	12	1
10.10	20	<input type="checkbox"/>	MPS1080-L20C	218.0	255.0	258.0	304.0	302	2.0	12	1
	25	<input type="checkbox"/>	MPS1080-L25C	272.0	310.0	313.0	359.0	357	2.0	12	1

WIERCENIE (WIERTŁA PEŁNOWĘGLIKOWE)

MPS

Wiertła z podwójną łysinką
i wiertła super długie

WĘGLIKI
SPIEKANE

M
WIERCENIE

DC (mm)	Głębokość otworu (L/D)	VP15TF	Numer zamówieniowy	Wymiary (mm)							Typ
				LU	LCF	LH	OAL	LF	PL	DCON	
10.9	3	<input type="checkbox"/>	MPS1090S-DIN-C	38.6	55.0	56.0	102.0	100	2.0	12	1
	5	<input type="checkbox"/>	MPS1090L-DIN-C	54.6	71.0	72.0	118.0	116	2.0	12	1
	8	<input type="checkbox"/>	MPS1090-L8C	89.2	123.0	126.0	172.0	170	2.0	12	1
	10	<input type="checkbox"/>	MPS1090-L10C	111.0	145.0	148.0	194.0	192	2.0	12	1
	12	<input type="checkbox"/>	MPS1090-L12C	132.8	167.0	170.0	216.0	214	2.0	12	1
	15	<input type="checkbox"/>	MPS1090-L15C	165.5	198.0	203.0	249.0	247	2.0	12	1
	20	<input type="checkbox"/>	MPS1090-L20C	220.0	255.0	258.0	304.0	302	2.0	12	1
25	<input type="checkbox"/>	MPS1090-L25C	274.5	310.0	313.0	359.0	357	2.0	12	1	
11.0	3	<input type="checkbox"/>	MPS1100S-DIN-C	38.5	55.0	56.0	102.0	100	2.0	12	1
	5	<input type="checkbox"/>	MPS1100L-DIN-C	54.5	71.0	72.0	118.0	116	2.0	12	1
	8	<input type="checkbox"/>	MPS1100-L8C	90.0	123.0	126.0	172.0	170	2.0	12	1
	10	<input type="checkbox"/>	MPS1100-L10C	112.0	145.0	148.0	194.0	192	2.0	12	1
	12	<input type="checkbox"/>	MPS1100-L12C	134.0	167.0	170.0	216.0	214	2.0	12	1
	15	<input type="checkbox"/>	MPS1100-L15C	167.0	198.0	203.0	249.0	247	2.0	12	1
	20	<input type="checkbox"/>	MPS1100-L20C	222.0	255.0	258.0	304.0	302	2.0	12	1
25	<input type="checkbox"/>	MPS1100-L25C	277.0	310.0	313.0	359.0	357	2.0	12	1	
11.1	3	<input type="checkbox"/>	MPS1110S-DIN-C	38.4	55.0	56.0	102.0	100	2.0	12	1
	5	<input type="checkbox"/>	MPS1110L-DIN-C	54.4	71.0	72.0	118.0	116	2.0	12	1
	8	<input type="checkbox"/>	MPS1110-L8C	90.8	129.0	132.0	178.0	176	2.0	12	1
	10	<input type="checkbox"/>	MPS1110-L10C	113.0	152.0	155.0	201.0	199	2.0	12	1
	12	<input type="checkbox"/>	MPS1110-L12C	135.2	175.0	178.0	224.0	222	2.0	12	1
	15	<input type="checkbox"/>	MPS1110-L15C	168.5	209.0	212.0	258.0	256	2.0	12	1
	20	<input type="checkbox"/>	MPS1110-L20C	224.0	267.0	270.0	316.0	314	2.0	12	1
25	<input type="checkbox"/>	MPS1110-L25C	279.5	324.0	327.0	373.0	371	2.0	12	1	
11.2	3	<input type="checkbox"/>	MPS1120S-DIN-C	38.2	55.0	56.0	102.0	100	2.0	12	1
	5	<input type="checkbox"/>	MPS1120L-DIN-C	54.2	71.0	72.0	118.0	116	2.0	12	1
	8	<input type="checkbox"/>	MPS1120-L8C	91.6	129.0	132.0	178.0	176	2.0	12	1
	10	<input type="checkbox"/>	MPS1120-L10C	114.0	152.0	155.0	201.0	199	2.0	12	1
	12	<input type="checkbox"/>	MPS1120-L12C	136.4	175.0	178.0	224.0	222	2.0	12	1
	15	<input type="checkbox"/>	MPS1120-L15C	170.0	209.0	212.0	258.0	256	2.0	12	1
	20	<input type="checkbox"/>	MPS1120-L20C	226.0	267.0	270.0	316.0	314	2.0	12	1
25	<input type="checkbox"/>	MPS1120-L25C	282.0	324.0	327.0	373.0	371	2.0	12	1	
11.3	3	<input type="checkbox"/>	MPS1130S-DIN-C	38.1	55.1	56.1	102.1	100	2.1	12	1
	5	<input type="checkbox"/>	MPS1130L-DIN-C	54.1	71.1	72.1	118.1	116	2.1	12	1
	8	<input type="checkbox"/>	MPS1130-L8C	92.5	129.1	132.1	178.1	176	2.1	12	1
	10	<input type="checkbox"/>	MPS1130-L10C	115.1	152.1	155.1	201.1	199	2.1	12	1
	12	<input type="checkbox"/>	MPS1130-L12C	137.7	175.1	178.0	224.0	222	2.1	12	1
	15	<input type="checkbox"/>	MPS1130-L15C	171.6	209.1	212.1	258.1	256	2.1	12	1
	20	<input type="checkbox"/>	MPS1130-L20C	228.1	267.1	270.1	316.1	314	2.1	12	1
25	<input type="checkbox"/>	MPS1130-L25C	284.6	324.1	327.1	373.1	371	2.1	12	1	
11.4	3	<input type="checkbox"/>	MPS1140S-DIN-C	38.0	55.1	56.1	102.1	100	2.1	12	1
	5	<input type="checkbox"/>	MPS1140L-DIN-C	54.0	71.1	72.1	118.1	116	2.1	12	1
	8	<input type="checkbox"/>	MPS1140-L8C	93.3	129.1	132.1	178.1	176	2.1	12	1
	10	<input type="checkbox"/>	MPS1140-L10C	116.1	152.1	155.1	201.1	199	2.1	12	1
	12	<input type="checkbox"/>	MPS1140-L12C	138.9	175.1	178.0	224.0	222	2.1	12	1
	15	<input type="checkbox"/>	MPS1140-L15C	173.1	209.1	212.1	258.1	256	2.1	12	1
	20	<input type="checkbox"/>	MPS1140-L20C	230.1	267.1	270.1	316.1	314	2.1	12	1
25	<input type="checkbox"/>	MPS1140-L25C	287.1	324.1	327.1	373.1	371	2.1	12	1	
11.5	3	<input type="checkbox"/>	MPS1150S-DIN-C	37.8	55.1	56.1	102.1	100	2.1	12	1
	5	<input type="checkbox"/>	MPS1150L-DIN-C	53.8	71.1	72.1	118.1	116	2.1	12	1
	8	<input type="checkbox"/>	MPS1150-L8C	94.1	129.1	132.1	178.1	176	2.1	12	1
	10	<input type="checkbox"/>	MPS1150-L10C	117.1	152.1	155.1	201.1	199	2.1	12	1
	12	<input type="checkbox"/>	MPS1150-L12C	140.1	175.1	178.0	224.0	222	2.1	12	1
	15	<input type="checkbox"/>	MPS1150-L15C	174.6	209.1	212.1	258.1	256	2.1	12	1
	20	<input type="checkbox"/>	MPS1150-L20C	232.1	267.1	270.1	316.1	314	2.1	12	1
25	<input type="checkbox"/>	MPS1150-L25C	289.6	324.1	327.1	373.1	371	2.1	12	1	

DC (mm)	Głębokość otworu (L/D)	VP15TF	Numer zamówieniowy	Wymiary (mm)							Typ
				LU	LCF	LH	OAL	LF	PL	DCON	
11.6	3	<input type="checkbox"/>	MPS1160S-DIN-C	37.7	55.1	56.1	102.1	100	2.1	12	1
	5	<input type="checkbox"/>	MPS1160L-DIN-C	53.7	71.1	72.1	118.1	116	2.1	12	1
	8	<input type="checkbox"/>	MPS1160-L8C	94.9	134.1	137.1	183.1	181	2.1	12	1
	10	<input type="checkbox"/>	MPS1160-L10C	118.1	158.1	161.1	207.1	205	2.1	12	1
	12	<input type="checkbox"/>	MPS1160-L12C	141.3	182.1	185.1	231.1	229	2.1	12	1
	15	<input type="checkbox"/>	MPS1160-L15C	176.1	218.1	221.1	267.1	265	2.1	12	1
	20	<input type="checkbox"/>	MPS1160-L20C	234.1	278.1	281.1	327.1	325	2.1	12	1
25	<input type="checkbox"/>	MPS1160-L25C	292.1	338.1	341.1	387.1	385	2.1	12	1	
11.7	3	<input type="checkbox"/>	MPS1170S-DIN-C	37.6	55.1	56.1	102.1	100	2.1	12	1
	5	<input type="checkbox"/>	MPS1170L-DIN-C	53.6	71.1	72.1	118.1	116	2.1	12	1
	8	<input type="checkbox"/>	MPS1170-L8C	95.7	134.1	137.1	183.1	181	2.1	12	1
	10	<input type="checkbox"/>	MPS1170-L10C	119.1	158.1	161.1	207.1	205	2.1	12	1
	12	<input type="checkbox"/>	MPS1170-L12C	142.5	182.1	185.1	231.1	229	2.1	12	1
	15	<input type="checkbox"/>	MPS1170-L15C	177.6	218.1	221.1	267.1	265	2.1	12	1
	20	<input type="checkbox"/>	MPS1170-L20C	236.1	278.1	281.1	327.1	325	2.1	12	1
25	<input type="checkbox"/>	MPS1170-L25C	294.6	338.1	341.1	387.1	385	2.1	12	1	
11.8	3	<input type="checkbox"/>	MPS1180S-DIN-C	37.4	55.1	56.1	102.1	100	2.1	12	1
	5	<input type="checkbox"/>	MPS1180L-DIN-C	53.4	71.1	72.1	118.1	116	2.1	12	1
	8	<input type="checkbox"/>	MPS1180-L8C	96.5	134.1	137.1	183.1	181	2.1	12	1
	10	<input type="checkbox"/>	MPS1180-L10C	120.1	158.1	161.1	207.1	205	2.1	12	1
	12	<input type="checkbox"/>	MPS1180-L12C	143.7	182.1	185.1	231.1	229	2.1	12	1
	15	<input type="checkbox"/>	MPS1180-L15C	179.1	218.1	221.1	267.1	265	2.1	12	1
	20	<input type="checkbox"/>	MPS1180-L20C	238.1	278.1	281.1	327.1	325	2.1	12	1
25	<input type="checkbox"/>	MPS1180-L25C	297.1	338.1	341.1	387.1	385	2.1	12	1	
11.9	3	<input type="checkbox"/>	MPS1190S-DIN-C	37.3	55.2	56.2	102.2	100	2.2	12	1
	5	<input type="checkbox"/>	MPS1190L-DIN-C	53.3	71.2	72.2	118.2	116	2.2	12	1
	8	<input type="checkbox"/>	MPS1190-L8C	97.4	134.2	137.2	183.2	181	2.2	12	1
	10	<input type="checkbox"/>	MPS1190-L10C	121.2	158.2	161.2	207.2	205	2.2	12	1
	12	<input type="checkbox"/>	MPS1190-L12C	145.0	182.2	185.2	231.2	229	2.2	12	1
	15	<input type="checkbox"/>	MPS1190-L15C	180.7	218.2	221.2	267.2	265	2.2	12	1
	20	<input type="checkbox"/>	MPS1190-L20C	240.2	278.2	281.2	327.2	325	2.2	12	1
25	<input type="checkbox"/>	MPS1190-L25C	299.7	338.2	341.2	387.2	385	2.2	12	1	
12.0	3	<input type="checkbox"/>	MPS1200S-DIN-C	37.2	55.2	56.2	102.2	100	2.2	12	2
	5	<input type="checkbox"/>	MPS1200L-DIN-C	53.2	71.2	72.2	118.2	116	2.2	12	2
	8	<input type="checkbox"/>	MPS1200-L8C	98.2	134.2	137.2	183.2	181	2.2	12	2
	10	<input type="checkbox"/>	MPS1200-L10C	122.2	158.2	161.2	207.2	205	2.2	12	2
	12	<input type="checkbox"/>	MPS1200-L12C	146.2	182.2	185.2	231.2	229	2.2	12	2
	15	<input type="checkbox"/>	MPS1200-L15C	182.2	218.2	221.2	267.2	265	2.2	12	2
	20	<input type="checkbox"/>	MPS1200-L20C	242.2	278.2	281.2	327.2	325	2.2	12	2
25	<input type="checkbox"/>	MPS1200-L25C	302.2	338.2	341.2	387.2	385	2.2	12	2	
12.05	3	<input type="checkbox"/>	MPS1205S-DIN-C	42.1	60.2	61.2	107.2	105	2.2	14	1
	5	<input type="checkbox"/>	MPS1205L-DIN-C	59.1	77.2	78.2	124.2	122	2.2	14	1
12.1	3	<input type="checkbox"/>	MPS1210S-DIN-C	42.1	60.2	61.2	107.2	105	2.2	14	1
	5	<input type="checkbox"/>	MPS1210L-DIN-C	59.1	77.2	78.2	124.2	122	2.2	14	1
	8	<input type="checkbox"/>	MPS1210-L8C	99.0	140.2	143.2	189.2	187	2.2	14	1
	10	<input type="checkbox"/>	MPS1210-L10C	123.2	165.2	168.2	214.2	212	2.2	14	1
	12	<input type="checkbox"/>	MPS1210-L12C	147.4	190.2	193.2	239.2	237	2.2	14	1
	15	<input type="checkbox"/>	MPS1210-L15C	183.7	227.2	230.2	276.2	274	2.2	14	1
	20	<input type="checkbox"/>	MPS1210-L20C	244.2	290.2	293.2	339.2	337	2.2	14	1
12.2	3	<input type="checkbox"/>	MPS1220S-DIN-C	41.9	60.2	61.2	107.2	105	2.2	14	1
	5	<input type="checkbox"/>	MPS1220L-DIN-C	58.9	77.2	78.2	124.2	122	2.2	14	1
	8	<input type="checkbox"/>	MPS1220-L8C	99.8	140.2	143.2	189.2	187	2.2	14	1
	10	<input type="checkbox"/>	MPS1220-L10C	124.2	165.2	168.2	214.2	212	2.2	14	1
	12	<input type="checkbox"/>	MPS1220-L12C	148.6	190.2	193.2	239.2	237	2.2	14	1
	15	<input type="checkbox"/>	MPS1220-L15C	185.2	227.2	230.2	276.2	274	2.2	14	1
	20	<input type="checkbox"/>	MPS1220-L20C	246.2	290.2	293.2	339.2	337	2.2	14	1

: Niestandardowy, produkowany na specjalne zamówienie.

DC (mm)	Głębokość otworu (L/D)	VP15TF	Numer zamówieniowy	Wymiary (mm)							Typ
				LU	LCF	LH	OAL	LF	PL	DCON	
12.3	3	<input type="checkbox"/>	MPS1230S-DIN-C	41.8	60.2	61.2	107.2	105	2.2	14	1
	5	<input type="checkbox"/>	MPS1230L-DIN-C	58.8	77.2	78.2	124.2	122	2.2	14	1
	8	<input type="checkbox"/>	MPS1230-L8C	100.6	140.2	143.2	189.2	187	2.2	14	1
	10	<input type="checkbox"/>	MPS1230-L10C	125.2	165.2	168.2	214.2	212	2.2	14	1
	12	<input type="checkbox"/>	MPS1230-L12C	149.8	190.2	193.2	239.2	237	2.2	14	1
	15	<input type="checkbox"/>	MPS1230-L15C	186.7	227.2	230.2	276.2	274	2.2	14	1
20	<input type="checkbox"/>	MPS1230-L20C	248.2	290.2	293.2	339.2	337	2.2	14	1	
12.4	3	<input type="checkbox"/>	MPS1240S-DIN-C	41.7	60.3	61.3	107.3	105	2.3	14	1
	5	<input type="checkbox"/>	MPS1240L-DIN-C	58.7	77.3	78.3	124.3	122	2.3	14	1
	8	<input type="checkbox"/>	MPS1240-L8C	101.5	140.3	143.3	189.3	187	2.3	14	1
	10	<input type="checkbox"/>	MPS1240-L10C	126.3	165.3	168.3	214.3	212	2.3	14	1
	12	<input type="checkbox"/>	MPS1240-L12C	151.1	190.3	193.3	239.3	237	2.3	14	1
	15	<input type="checkbox"/>	MPS1240-L15C	188.3	227.3	230.3	276.3	274	2.3	14	1
20	<input type="checkbox"/>	MPS1240-L20C	250.3	290.3	293.3	339.3	337	2.3	14	1	
12.5	3	<input type="checkbox"/>	MPS1250S-DIN-C	41.5	60.3	61.3	107.3	105	2.3	14	1
	5	<input type="checkbox"/>	MPS1250L-DIN-C	58.5	77.3	78.3	124.3	122	2.3	14	1
	8	<input type="checkbox"/>	MPS1250-L8C	102.3	140.3	143.3	189.3	187	2.3	14	1
	10	<input type="checkbox"/>	MPS1250-L10C	127.3	165.3	168.3	214.3	212	2.3	14	1
	12	<input type="checkbox"/>	MPS1250-L12C	152.3	190.3	193.3	239.3	237	2.3	14	1
	15	<input type="checkbox"/>	MPS1250-L15C	189.8	227.3	230.3	276.3	274	2.3	14	1
20	<input type="checkbox"/>	MPS1250-L20C	252.3	290.3	293.3	339.3	337	2.3	14	1	
12.6	3	<input type="checkbox"/>	MPS1260S-DIN-C	41.4	60.3	61.3	107.3	105	2.3	14	1
	5	<input type="checkbox"/>	MPS1260L-DIN-C	58.4	77.3	78.3	124.3	122	2.3	14	1
	8	<input type="checkbox"/>	MPS1260-L8C	103.1	145.3	148.3	194.3	192	2.3	14	1
	10	<input type="checkbox"/>	MPS1260-L10C	128.3	171.3	174.3	220.3	218	2.3	14	1
	12	<input type="checkbox"/>	MPS1260-L12C	153.5	197.3	200.3	246.3	244	2.3	14	1
	15	<input type="checkbox"/>	MPS1260-L15C	191.3	236.3	239.3	285.3	283	2.3	14	1
20	<input type="checkbox"/>	MPS1260-L20C	254.3	301.3	304.3	350.3	348	2.3	14	1	
12.7	3	<input type="checkbox"/>	MPS1270S-DIN-C	41.3	60.3	61.3	107.3	105	2.3	14	1
	5	<input type="checkbox"/>	MPS1270L-DIN-C	58.3	77.3	78.3	124.3	122	2.3	14	1
	8	<input type="checkbox"/>	MPS1270-L8C	103.9	145.3	148.3	194.3	192	2.3	14	1
	10	<input type="checkbox"/>	MPS1270-L10C	129.3	171.3	174.3	220.3	218	2.3	14	1
	12	<input type="checkbox"/>	MPS1270-L12C	154.7	197.3	200.3	246.3	244	2.3	14	1
	15	<input type="checkbox"/>	MPS1270-L15C	192.8	236.3	239.3	285.3	283	2.3	14	1
20	<input type="checkbox"/>	MPS1270-L20C	256.3	301.3	304.3	350.3	348	2.3	14	1	
12.8	3	<input type="checkbox"/>	MPS1280S-DIN-C	41.1	60.3	61.3	107.3	105	2.3	14	1
	5	<input type="checkbox"/>	MPS1280L-DIN-C	58.1	77.3	78.3	124.3	122	2.3	14	1
	8	<input type="checkbox"/>	MPS1280-L8C	104.7	145.3	148.3	194.3	192	2.3	14	1
	10	<input type="checkbox"/>	MPS1280-L10C	130.3	171.3	174.3	220.3	218	2.3	14	1
	12	<input type="checkbox"/>	MPS1280-L12C	155.9	197.3	200.3	246.3	244	2.3	14	1
	15	<input type="checkbox"/>	MPS1280-L15C	194.3	236.3	239.3	285.3	283	2.3	14	1
20	<input type="checkbox"/>	MPS1280-L20C	258.3	301.3	304.3	350.3	348	2.3	14	1	
12.9	3	<input type="checkbox"/>	MPS1290S-DIN-C	41.0	60.3	61.3	107.3	105	2.3	14	1
	5	<input type="checkbox"/>	MPS1290L-DIN-C	58.0	77.3	78.3	124.3	122	2.3	14	1
	8	<input type="checkbox"/>	MPS1290-L8C	105.5	145.3	148.3	194.3	192	2.3	14	1
	10	<input type="checkbox"/>	MPS1290-L10C	131.3	171.3	174.3	220.3	218	2.3	14	1
	12	<input type="checkbox"/>	MPS1290-L12C	157.1	197.3	200.3	246.3	244	2.3	14	1
	15	<input type="checkbox"/>	MPS1290-L15C	195.8	236.3	239.3	285.3	283	2.3	14	1
20	<input type="checkbox"/>	MPS1290-L20C	260.3	301.3	304.3	350.3	348	2.3	14	1	
13.0	3	<input type="checkbox"/>	MPS1300S-DIN-C	40.9	60.4	61.4	107.4	105	2.4	14	1
	5	<input type="checkbox"/>	MPS1300L-DIN-C	57.9	77.4	78.4	124.4	122	2.4	14	1
	8	<input type="checkbox"/>	MPS1300-L8C	106.4	145.4	148.4	194.4	192	2.4	14	1
	10	<input type="checkbox"/>	MPS1300-L10C	132.4	171.4	174.4	220.4	218	2.4	14	1
	12	<input type="checkbox"/>	MPS1300-L12C	158.4	197.4	200.4	246.4	244	2.4	14	1
	15	<input type="checkbox"/>	MPS1300-L15C	197.4	236.4	239.4	285.4	283	2.4	14	1
20	<input type="checkbox"/>	MPS1300-L20C	262.4	301.4	304.4	350.4	348	2.4	14	1	

DC (mm)	Głębokość otworu (L/D)	VP15TF	Numer zamówieniowy	Wymiary (mm)							Typ
				LU	LCF	LH	OAL	LF	PL	DCON	
13.1	3	<input type="checkbox"/>	MPS1310S-DIN-C	40.7	60.4	61.4	107.4	105	2.4	14	1
	5	<input type="checkbox"/>	MPS1310L-DIN-C	57.7	77.4	78.4	124.4	122	2.4	14	1
	8	<input type="checkbox"/>	MPS1310-L8C	107.2	151.4	154.4	200.4	198	2.4	14	1
	10	<input type="checkbox"/>	MPS1310-L10C	133.4	178.4	181.4	227.4	225	2.4	14	1
	12	<input type="checkbox"/>	MPS1310-L12C	159.6	205.4	208.4	254.4	252	2.4	14	1
	15	<input type="checkbox"/>	MPS1310-L15C	198.9	245.4	248.4	294.4	292	2.4	14	1
20	<input type="checkbox"/>	MPS1310-L20C	264.4	313.4	316.4	362.4	360	2.4	14	1	
13.2	3	<input type="checkbox"/>	MPS1320S-DIN-C	40.6	60.4	61.4	107.4	105	2.4	14	1
	5	<input type="checkbox"/>	MPS1320L-DIN-C	57.6	77.4	78.4	124.4	122	2.4	14	1
	8	<input type="checkbox"/>	MPS1320-L8C	108.0	151.4	154.4	200.4	198	2.4	14	1
	10	<input type="checkbox"/>	MPS1320-L10C	134.4	178.4	181.4	227.4	225	2.4	14	1
	12	<input type="checkbox"/>	MPS1320-L12C	160.8	205.4	208.4	254.4	252	2.4	14	1
	15	<input type="checkbox"/>	MPS1320-L15C	200.4	245.4	248.4	294.4	292	2.4	14	1
20	<input type="checkbox"/>	MPS1320-L20C	266.4	313.4	316.4	362.4	360	2.4	14	1	
13.3	3	<input type="checkbox"/>	MPS1330S-DIN-C	40.5	60.4	61.4	107.4	105	2.4	14	1
	5	<input type="checkbox"/>	MPS1330L-DIN-C	57.5	77.4	78.4	124.4	122	2.4	14	1
	8	<input type="checkbox"/>	MPS1330-L8C	108.8	151.4	154.4	200.4	198	2.4	14	1
	10	<input type="checkbox"/>	MPS1330-L10C	135.4	178.4	181.4	227.4	225	2.4	14	1
	12	<input type="checkbox"/>	MPS1330-L12C	162.0	205.4	208.4	254.4	252	2.4	14	1
	15	<input type="checkbox"/>	MPS1330-L15C	201.9	245.4	248.4	294.4	292	2.4	14	1
20	<input type="checkbox"/>	MPS1330-L20C	268.4	313.4	316.4	362.4	360	2.4	14	1	
13.4	3	<input type="checkbox"/>	MPS1340S-DIN-C	40.3	60.4	61.4	107.4	105	2.4	14	1
	5	<input type="checkbox"/>	MPS1340L-DIN-C	57.3	77.4	78.4	124.4	122	2.4	14	1
	8	<input type="checkbox"/>	MPS1340-L8C	109.6	151.4	154.4	200.4	198	2.4	14	1
	10	<input type="checkbox"/>	MPS1340-L10C	136.4	178.4	181.4	227.4	225	2.4	14	1
	12	<input type="checkbox"/>	MPS1340-L12C	163.2	205.4	208.4	254.4	252	2.4	14	1
	15	<input type="checkbox"/>	MPS1340-L15C	203.4	245.4	248.4	294.4	292	2.4	14	1
20	<input type="checkbox"/>	MPS1340-L20C	270.4	313.4	316.4	362.4	360	2.4	14	1	
13.5	3	<input type="checkbox"/>	MPS1350S-DIN-C	40.2	60.5	61.5	107.5	105	2.5	14	1
	5	<input type="checkbox"/>	MPS1350L-DIN-C	57.2	77.5	78.5	124.5	122	2.5	14	1
	8	<input type="checkbox"/>	MPS1350-L8C	110.5	151.5	154.5	200.5	198	2.5	14	1
	10	<input type="checkbox"/>	MPS1350-L10C	137.5	178.5	181.5	227.5	225	2.5	14	1
	12	<input type="checkbox"/>	MPS1350-L12C	164.5	205.5	208.5	254.5	252	2.5	14	1
	15	<input type="checkbox"/>	MPS1350-L15C	205.0	245.5	248.5	294.5	292	2.5	14	1
20	<input type="checkbox"/>	MPS1350-L20C	272.5	313.5	316.5	362.5	360	2.5	14	1	
13.6	3	<input type="checkbox"/>	MPS1360S-DIN-C	40.1	60.5	61.5	107.5	105	2.5	14	1
	5	<input type="checkbox"/>	MPS1360L-DIN-C	57.1	77.5	78.5	124.5	122	2.5	14	1
	8	<input type="checkbox"/>	MPS1360-L8C	111.3	156.5	159.5	205.5	203	2.5	14	1
	10	<input type="checkbox"/>	MPS1360-L10C	138.5	184.5	187.5	233.5	231	2.5	14	1
	12	<input type="checkbox"/>	MPS1360-L12C	165.7	212.5	215.5	261.5	259	2.5	14	1
	15	<input type="checkbox"/>	MPS1360-L15C	206.5	254.5	257.5	303.5	301	2.5	14	1
20	<input type="checkbox"/>	MPS1360-L20C	274.5	324.5	327.5	373.5	371	2.5	14	1	
13.7	3	<input type="checkbox"/>	MPS1370S-DIN-C	39.9	60.5	61.5	107.5	105	2.5	14	1
	5	<input type="checkbox"/>	MPS1370L-DIN-C	56.9	77.5	78.5	124.5	122	2.5	14	1
	8	<input type="checkbox"/>	MPS1370-L8C	112.1	156.5	159.5	205.5	203	2.5	14	1
	10	<input type="checkbox"/>	MPS1370-L10C	139.5	184.5	187.5	233.5	231	2.5	14	1
	12	<input type="checkbox"/>	MPS1370-L12C	166.9	212.5	215.5	261.5	259	2.5	14	1
	15	<input type="checkbox"/>	MPS1370-L15C	208.0	254.5	257.5	303.5	301	2.5	14	1
20	<input type="checkbox"/>	MPS1370-L20C	276.5	324.5	327.5	373.5	371	2.5	14	1	
13.8	3	<input type="checkbox"/>	MPS1380S-DIN-C	39.8	60.5	61.5	107.5	105	2.5	14	1
	5	<input type="checkbox"/>	MPS1380L-DIN-C	56.8	77.5	78.5	124.5	122	2.5	14	1
	8	<input type="checkbox"/>	MPS1380-L8C	112.9	156.5	159.5	205.5	203	2.5	14	1
	10	<input type="checkbox"/>	MPS1380-L10C	140.5	184.5	187.5	233.5	231	2.5	14	1
	12	<input type="checkbox"/>	MPS1380-L12C	168.1	212.5	215.5	261.5	259	2.5	14	1
	15	<input type="checkbox"/>	MPS1380-L15C	209.5	254.5	257.5	303.5	301	2.5	14	1
20	<input type="checkbox"/>	MPS1380-L20C	278.5	324.5	327.5	373.5	371	2.5	14	1	

WIERCENIE (WIERTŁA PEŁNOWĘGLIKOWE)

MPS

Wiertła z podwójną lysinką
i wiertła super długie

WĘGLIKI
SPIEKANE

M
WIERCENIE

DC (mm)	Głębokość otworu (L/D)	VP15TF	Numer zamówieniowy	Wymiary (mm)							Typ
				LU	LCF	LH	OAL	LF	PL	DCON	
13.9	3	<input type="checkbox"/>	MPS1390S-DIN-C	39.7	60.5	61.5	107.5	105	2.5	14	1
	5	<input type="checkbox"/>	MPS1390L-DIN-C	56.7	77.5	78.5	124.5	122	2.5	14	1
	8	<input type="checkbox"/>	MPS1390-L8C	113.7	156.5	159.5	205.5	203	2.5	14	1
	10	<input type="checkbox"/>	MPS1390-L10C	141.5	184.5	187.5	233.5	231	2.5	14	1
	12	<input type="checkbox"/>	MPS1390-L12C	169.3	212.5	215.5	261.5	259	2.5	14	1
	15	<input type="checkbox"/>	MPS1390-L15C	211.0	254.5	257.5	303.5	301	2.5	14	1
20	<input type="checkbox"/>	MPS1390-L20C	280.5	324.5	327.5	373.5	371	2.5	14	1	
14.0	3	<input type="checkbox"/>	MPS1400S-DIN-C	39.5	60.5	61.5	107.5	105	2.5	14	2
	5	<input type="checkbox"/>	MPS1400L-DIN-C	56.5	77.5	78.5	124.5	122	2.5	14	2
	8	<input type="checkbox"/>	MPS1400-L8C	114.5	156.5	159.5	205.5	203	2.5	14	2
	10	<input type="checkbox"/>	MPS1400-L10C	142.5	184.5	187.5	233.5	231	2.5	14	2
	12	<input type="checkbox"/>	MPS1400-L12C	170.5	212.5	215.5	261.5	259	2.5	14	2
	15	<input type="checkbox"/>	MPS1400-L15C	212.5	254.5	257.5	303.5	301	2.5	14	2
20	<input type="checkbox"/>	MPS1400-L20C	282.5	324.5	327.5	373.5	371	2.5	14	2	
14.1	3	<input type="checkbox"/>	MPS1410S-DIN-C	43.4	64.6	65.6	114.6	112	2.6	16	1
	5	<input type="checkbox"/>	MPS1410L-DIN-C	61.4	82.6	83.6	132.6	130	2.6	16	1
14.2	3	<input type="checkbox"/>	MPS1420S-DIN-C	43.3	64.6	65.6	114.6	112	2.6	16	1
	5	<input type="checkbox"/>	MPS1420L-DIN-C	61.3	82.6	83.6	132.6	130	2.6	16	1
14.3	3	<input type="checkbox"/>	MPS1430S-DIN-C	43.2	64.6	65.6	114.6	112	2.6	16	1
	5	<input type="checkbox"/>	MPS1430L-DIN-C	61.2	82.6	83.6	132.6	130	2.6	16	1
14.4	3	<input type="checkbox"/>	MPS1440S-DIN-C	43.0	64.6	65.6	114.6	112	2.6	16	1
	5	<input type="checkbox"/>	MPS1440L-DIN-C	61.0	82.6	83.6	132.6	130	2.6	16	1
14.5	3	<input type="checkbox"/>	MPS1450S-DIN-C	42.9	64.6	65.6	114.6	112	2.6	16	1
	5	<input type="checkbox"/>	MPS1450L-DIN-C	60.9	82.6	83.6	132.6	130	2.6	16	1
14.6	3	<input type="checkbox"/>	MPS1460S-DIN-C	42.8	64.7	65.7	114.7	112	2.7	16	1
	5	<input type="checkbox"/>	MPS1460L-DIN-C	60.8	82.7	83.7	132.7	130	2.7	16	1
14.7	3	<input type="checkbox"/>	MPS1470S-DIN-C	42.6	64.7	65.7	114.7	112	2.7	16	1
	5	<input type="checkbox"/>	MPS1470L-DIN-C	60.6	82.7	83.7	132.7	130	2.7	16	1
14.8	3	<input type="checkbox"/>	MPS1480S-DIN-C	42.5	64.7	65.7	114.7	112	2.7	16	1
	5	<input type="checkbox"/>	MPS1480L-DIN-C	60.5	82.7	83.7	132.7	130	2.7	16	1
14.9	3	<input type="checkbox"/>	MPS1490S-DIN-C	42.4	64.7	65.7	114.7	112	2.7	16	1
	5	<input type="checkbox"/>	MPS1490L-DIN-C	60.4	82.7	83.7	132.7	130	2.7	16	1
15.0	3	<input type="checkbox"/>	MPS1500S-DIN-C	42.2	64.7	65.7	114.7	112	2.7	16	1
	5	<input type="checkbox"/>	MPS1500L-DIN-C	60.2	82.7	83.7	132.7	130	2.7	16	1
15.1	3	<input type="checkbox"/>	MPS1510S-DIN-C	42.1	64.7	65.7	114.7	112	2.7	16	1
	5	<input type="checkbox"/>	MPS1510L-DIN-C	60.1	82.7	83.7	132.7	130	2.7	16	1
15.2	3	<input type="checkbox"/>	MPS1520S-DIN-C	42.0	64.8	65.8	114.8	112	2.8	16	1
	5	<input type="checkbox"/>	MPS1520L-DIN-C	60.0	82.8	83.8	132.8	130	2.8	16	1
15.3	3	<input type="checkbox"/>	MPS1530S-DIN-C	41.8	64.8	65.8	114.8	112	2.8	16	1
	5	<input type="checkbox"/>	MPS1530L-DIN-C	59.8	82.8	83.8	132.8	130	2.8	16	1
15.4	3	<input type="checkbox"/>	MPS1540S-DIN-C	41.7	64.8	65.8	114.8	112	2.8	16	1
	5	<input type="checkbox"/>	MPS1540L-DIN-C	59.7	82.8	83.8	132.8	130	2.8	16	1
15.5	3	<input type="checkbox"/>	MPS1550S-DIN-C	41.6	64.8	65.8	114.8	112	2.8	16	1
	5	<input type="checkbox"/>	MPS1550L-DIN-C	59.6	82.8	83.8	132.8	130	2.8	16	1
15.6	3	<input type="checkbox"/>	MPS1560S-DIN-C	41.4	64.8	65.8	114.8	112	2.8	16	1
	5	<input type="checkbox"/>	MPS1560L-DIN-C	59.4	82.8	83.8	132.8	130	2.8	16	1
15.7	3	<input type="checkbox"/>	MPS1570S-DIN-C	41.3	64.9	65.9	114.9	112	2.9	16	1
	5	<input type="checkbox"/>	MPS1570L-DIN-C	59.3	82.9	83.9	132.9	130	2.9	16	1
15.8	3	<input type="checkbox"/>	MPS1580S-DIN-C	41.2	64.9	65.9	114.9	112	2.9	16	1
	5	<input type="checkbox"/>	MPS1580L-DIN-C	59.2	82.9	83.9	132.9	130	2.9	16	1
15.9	3	<input type="checkbox"/>	MPS1590S-DIN-C	41.0	64.9	65.9	114.9	112	2.9	16	1
	5	<input type="checkbox"/>	MPS1590L-DIN-C	59.0	82.9	83.9	132.9	130	2.9	16	1
16.0	3	<input type="checkbox"/>	MPS1600S-DIN-C	40.9	64.9	65.9	114.9	112	2.9	16	2
	5	<input type="checkbox"/>	MPS1600L-DIN-C	58.9	82.9	83.9	132.9	130	2.9	16	2
16.1	3	<input type="checkbox"/>	MPS1610S-DIN-C	48.8	72.9	73.9	122.9	120	2.9	18	1
	5	<input type="checkbox"/>	MPS1610L-DIN-C	68.8	92.9	93.9	142.9	140	2.9	18	1

DC (mm)	Głębokość otworu (L/D)	VP15TF	Numer zamówieniowy	Wymiary (mm)							Typ
				LU	LCF	LH	OAL	LF	PL	DCON	
16.2	3	<input type="checkbox"/>	MPS1620S-DIN-C	48.6	72.9	73.9	122.9	120	2.9	18	1
	5	<input type="checkbox"/>	MPS1620L-DIN-C	68.6	92.9	93.9	142.9	140	2.9	18	1
16.3	3	<input type="checkbox"/>	MPS1630S-DIN-C	48.5	73.0	74.0	123.0	120	3.0	18	1
	5	<input type="checkbox"/>	MPS1630L-DIN-C	68.5	93.0	94.0	143.0	140	3.0	18	1
16.4	3	<input type="checkbox"/>	MPS1640S-DIN-C	48.4	73.0	74.0	123.0	120	3.0	18	1
	5	<input type="checkbox"/>	MPS1640L-DIN-C	68.4	93.0	94.0	143.0	140	3.0	18	1
16.5	3	<input type="checkbox"/>	MPS1650S-DIN-C	48.3	73.0	74.0	123.0	120	3.0	18	1
	5	<input type="checkbox"/>	MPS1650L-DIN-C	68.3	93.0	94.0	143.0	140	3.0	18	1
16.6	3	<input type="checkbox"/>	MPS1660S-DIN-C	48.1	73.0	74.0	123.0	120	3.0	18	1
	5	<input type="checkbox"/>	MPS1660L-DIN-C	68.1	93.0	94.0	143.0	140	3.0	18	1
16.7	3	<input type="checkbox"/>	MPS1670S-DIN-C	48.0	73.0	74.0	123.0	120	3.0	18	1
	5	<input type="checkbox"/>	MPS1670L-DIN-C	68.0	93.0	94.0	143.0	140	3.0	18	1
16.8	3	<input type="checkbox"/>	MPS1680S-DIN-C	47.9	73.1	74.1	123.1	120	3.1	18	1
	5	<input type="checkbox"/>	MPS1680L-DIN-C	67.9	93.1	94.1	143.1	140	3.1	18	1
16.9	3	<input type="checkbox"/>	MPS1690S-DIN-C	47.7	73.1	74.1	123.1	120	3.1	18	1
	5	<input type="checkbox"/>	MPS1690L-DIN-C	67.7	93.1	94.1	143.1	140	3.1	18	1
17.0	3	<input type="checkbox"/>	MPS1700S-DIN-C	47.6	73.1	74.1	123.1	120	3.1	18	1
	5	<input type="checkbox"/>	MPS1700L-DIN-C	67.6	93.1	94.1	143.1	140	3.1	18	1
17.1	3	<input type="checkbox"/>	MPS1710S-DIN-C	47.5	73.1	74.1	123.1	120	3.1	18	1
	5	<input type="checkbox"/>	MPS1710L-DIN-C	67.5	93.1	94.1	143.1	140	3.1	18	1
17.2	3	<input type="checkbox"/>	MPS1720S-DIN-C	47.3	73.1	74.1	123.1	120	3.1	18	1
	5	<input type="checkbox"/>	MPS1720L-DIN-C	67.3	93.1	94.1	143.1	140	3.1	18	1
17.3	3	<input type="checkbox"/>	MPS1730S-DIN-C	47.2	73.1	74.1	123.1	120	3.1	18	1
	5	<input type="checkbox"/>	MPS1730L-DIN-C	67.2	93.1	94.1	143.1	140	3.1	18	1
17.4	3	<input type="checkbox"/>	MPS1740S-DIN-C	47.1	73.2	74.2	123.2	120	3.2	18	1
	5	<input type="checkbox"/>	MPS1740L-DIN-C	67.1	93.2	94.2	143.2	140	3.2	18	1
17.5	3	<input type="checkbox"/>	MPS1750S-DIN-C	46.9	73.2	74.2	123.2	120	3.2	18	1
	5	<input type="checkbox"/>	MPS1750L-DIN-C	66.9	93.2	94.2	143.2	140	3.2	18	1
17.6	3	<input type="checkbox"/>	MPS1760S-DIN-C	46.8	73.2	74.2	123.2	120	3.2	18	1
	5	<input type="checkbox"/>	MPS1760L-DIN-C	66.8	93.2	94.2	143.2	140	3.2	18	1
17.7	3	<input type="checkbox"/>	MPS1770S-DIN-C	46.7	73.2	74.2	123.2	120	3.2	18	1
	5	<input type="checkbox"/>	MPS1770L-DIN-C	66.7	93.2	94.2	143.2	140	3.2	18	1
17.8	3	<input type="checkbox"/>	MPS1780S-DIN-C	46.5	73.2	74.2	123.2	120	3.2	18	1
	5	<input type="checkbox"/>	MPS1780L-DIN-C	66.5	93.2	94.2	143.2	140	3.2	18	1
17.9	3	<input type="checkbox"/>	MPS1790S-DIN-C	46.4	73.3	74.3	123.3	120	3.3	18	1
	5	<input type="checkbox"/>	MPS1790L-DIN-C	66.4	93.3	94.3	143.3	140	3.3	18	1
18.0	3	<input type="checkbox"/>	MPS1800S-DIN-C	46.3	73.3	74.3	123.3	120	3.3	18	2
	5	<input type="checkbox"/>	MPS1800L-DIN-C	66.3	93.3	94.3	143.3	140	3.3	18	2
18.1	3	<input type="checkbox"/>	MPS1810S-DIN-C	52.1	79.3	80.3	131.3	128	3.3	20	1
	5	<input type="checkbox"/>	MPS1810L-DIN-C	74.1	101.3	102.3	153.3	150	3.3	20	1
18.2	3	<input type="checkbox"/>	MPS1820S-DIN-C	52.0	79.3	80.3	131.3	128	3.3	20	1
	5	<input type="checkbox"/>	MPS1820L-DIN-C	74.0	101.3	102.3	153.3	150	3.3	20	1
18.3	3	<input type="checkbox"/>	MPS1830S-DIN-C	51.9	79.3	80.3	131.3	128	3.3	20	1
	5	<input type="checkbox"/>	MPS1830L-DIN-C	73.9	101.3	102.3	153.3	150	3.3	20	1
18.4	3	<input type="checkbox"/>	MPS1840S-DIN-C	51.7	79.3	80.3	131.3	128	3.3	20	1
	5	<input type="checkbox"/>	MPS1840L-DIN-C	73.7	101.3	102.3	153.3	150	3.3	20	1
18.5	3	<input type="checkbox"/>	MPS1850S-DIN-C	51.6	79.4	80.4	131.4	128	3.4	20	1
	5	<input type="checkbox"/>	MPS1850L-DIN-C	73.6	101.4	102.4	153.4	150	3.4	20	1
18.6	3	<input type="checkbox"/>	MPS1860S-DIN-C	51.5	79.4	80.4	131.4	128	3.4	20	1
	5	<input type="checkbox"/>	MPS1860L-DIN-C	73.5	101.4	102.4	153.4	150	3.4	20	1
18.7	3	<input type="checkbox"/>	MPS1870S-DIN-C	51.4	79.4	80.4	131.4	128	3.4	20	1
	5	<input type="checkbox"/>	MPS1870L-DIN-C	73.4	101.4	102.4	153.4	150	3.4	20	1
18.8	3	<input type="checkbox"/>	MPS1880S-DIN-C	51.2	79.4	80.4	131.4	128	3.4	20	1
	5	<input type="checkbox"/>	MPS1880L-DIN-C	73.2	101.4	102.4	153.4	150	3.4	20	1
18.9	3	<input type="checkbox"/>	MPS1890S-DIN-C	51.1	79.4	80.4	131.4	128	3.4		

DC (mm)	Głębokość otworu (L/D)	VP15TF	Numer zamówieniowy	Wymiary (mm)							Typ
				LU	LCF	LH	OAL	LF	PL	DCON	
19.0	3	<input type="checkbox"/>	MPS1900S-DIN-C	51.0	79.5	80.5	131.5	128	3.5	20	1
	5	<input type="checkbox"/>	MPS1900L-DIN-C	73.0	101.5	102.5	153.5	150	3.5	20	1
19.1	3	<input type="checkbox"/>	MPS1910S-DIN-C	50.8	79.5	80.5	131.5	128	3.5	20	1
	5	<input type="checkbox"/>	MPS1910L-DIN-C	72.8	101.5	102.5	153.5	150	3.5	20	1
19.2	3	<input type="checkbox"/>	MPS1920S-DIN-C	50.7	79.5	80.5	131.5	128	3.5	20	1
	5	<input type="checkbox"/>	MPS1920L-DIN-C	72.7	101.5	102.5	153.5	150	3.5	20	1
19.3	3	<input type="checkbox"/>	MPS1930S-DIN-C	50.6	79.5	80.5	131.5	128	3.5	20	1
	5	<input type="checkbox"/>	MPS1930L-DIN-C	72.6	101.5	102.5	153.5	150	3.5	20	1
19.4	3	<input type="checkbox"/>	MPS1940S-DIN-C	50.4	79.5	80.5	131.5	128	3.5	20	1
	5	<input type="checkbox"/>	MPS1940L-DIN-C	72.4	101.5	102.5	153.5	150	3.5	20	1
19.5	3	<input type="checkbox"/>	MPS1950S-DIN-C	50.3	79.5	80.5	131.5	128	3.5	20	1
	5	<input type="checkbox"/>	MPS1950L-DIN-C	72.3	101.5	102.5	153.5	150	3.5	20	1
19.6	3	<input type="checkbox"/>	MPS1960S-DIN-C	50.2	79.6	80.6	131.6	128	3.6	20	1
	5	<input type="checkbox"/>	MPS1960L-DIN-C	72.2	101.6	102.6	153.6	150	3.6	20	1
19.7	3	<input type="checkbox"/>	MPS1970S-DIN-C	50.0	79.6	80.6	131.6	128	3.6	20	1
	5	<input type="checkbox"/>	MPS1970L-DIN-C	72.0	101.6	102.6	153.6	150	3.6	20	1
19.8	3	<input type="checkbox"/>	MPS1980S-DIN-C	49.9	79.6	80.6	131.6	128	3.6	20	1
	5	<input type="checkbox"/>	MPS1980L-DIN-C	71.9	101.6	102.6	153.6	150	3.6	20	1
19.9	3	<input type="checkbox"/>	MPS1990S-DIN-C	49.8	79.6	80.6	131.6	128	3.6	20	1
	5	<input type="checkbox"/>	MPS1990L-DIN-C	71.8	101.6	102.6	153.6	150	3.6	20	1
20.0	3	<input type="checkbox"/>	MPS2000S-DIN-C	49.6	79.6	80.6	131.6	128	3.6	20	2
	5	<input type="checkbox"/>	MPS2000L-DIN-C	71.6	101.6	102.6	153.6	150	3.6	20	2

WIERCENIE (WIERTŁA PEŁNOWĘGLIKOWE)

MSL

- Głębokość otworu: 20-30 L/D.
- MSL to wiertło ze standardową łysinką, co umożliwi dokładną obróbkę.



Wiertła z łysinką standardową, super długie

WĘGLIKI
SPIEKANE

- P M K N S H

Chłodzenie wewnętrzne

● Typ z chwytem walcowym

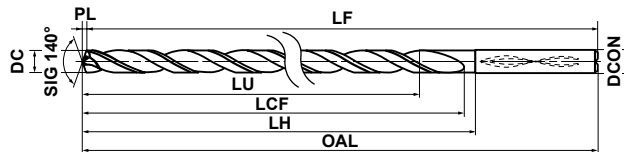

M

WIERCENIE

	3.0 ≤ DC ≤ 6.0	6.0 < DC ≤ 10.0	10.0 < DC ≤ 14.0
	0 -0.012	0 -0.015	0 -0.018
	0 -0.008	0 -0.009	0 -0.011

DC (mm)	Głębokość otworu (L/D)	VP15TF	Numer zamówieniowy	Wymiary (mm)						
				LU	LCF	LH	OAL	LF	PL	DCON
3.0	20	<input type="checkbox"/>	MSL0300-L20C	60.5	69.5	72.5	109.5	109	0.5	6
	25	<input type="checkbox"/>	MSL0300-L25C	75.5	84.5	87.5	124.5	124	0.5	6
	30	<input type="checkbox"/>	MSL0300-L30C	90.5	99.5	102.5	139.5	139	0.5	6
3.1	20	<input type="checkbox"/>	MSL0310-L20C	62.6	81.6	84.6	121.6	121	0.6	6
	25	<input type="checkbox"/>	MSL0310-L25C	78.1	98.6	101.6	138.6	138	0.6	6
	30	<input type="checkbox"/>	MSL0310-L30C	93.6	116.6	119.6	156.6	156	0.6	6
3.2	20	<input type="checkbox"/>	MSL0320-L20C	64.6	81.6	84.6	121.6	121	0.6	6
	25	<input type="checkbox"/>	MSL0320-L25C	80.6	98.6	101.6	138.6	138	0.6	6
	30	<input type="checkbox"/>	MSL0320-L30C	96.6	116.6	119.6	156.6	156	0.6	6
3.3	20	<input type="checkbox"/>	MSL0330-L20C	66.6	81.6	84.6	121.6	121	0.6	6
	25	<input type="checkbox"/>	MSL0330-L25C	83.1	98.6	101.6	138.6	138	0.6	6
	30	<input type="checkbox"/>	MSL0330-L30C	99.6	116.6	119.6	156.6	156	0.6	6
3.4	20	<input type="checkbox"/>	MSL0340-L20C	68.6	81.6	84.6	121.6	121	0.6	6
	25	<input type="checkbox"/>	MSL0340-L25C	85.6	98.6	101.6	138.6	138	0.6	6
	30	<input type="checkbox"/>	MSL0340-L30C	102.6	116.6	119.6	156.6	156	0.6	6
3.5	20	<input type="checkbox"/>	MSL0350-L20C	70.6	81.6	84.6	121.6	121	0.6	6
	25	<input type="checkbox"/>	MSL0350-L25C	88.1	98.6	101.6	138.6	138	0.6	6
	30	<input type="checkbox"/>	MSL0350-L30C	105.6	116.6	119.6	156.6	156	0.6	6
3.6	20	<input type="checkbox"/>	MSL0360-L20C	72.7	92.7	95.7	132.7	132	0.7	6
	25	<input type="checkbox"/>	MSL0360-L25C	90.7	112.7	115.7	152.7	152	0.7	6
	30	<input type="checkbox"/>	MSL0360-L30C	108.7	132.7	135.7	172.7	172	0.7	6
3.7	20	<input type="checkbox"/>	MSL0370-L20C	74.7	92.7	95.7	132.7	132	0.7	6
	25	<input type="checkbox"/>	MSL0370-L25C	93.2	112.7	115.7	152.7	152	0.7	6
	30	<input type="checkbox"/>	MSL0370-L30C	111.7	132.7	135.7	172.7	172	0.7	6
3.8	20	<input type="checkbox"/>	MSL0380-L20C	76.7	92.7	95.7	132.7	132	0.7	6
	25	<input type="checkbox"/>	MSL0380-L25C	95.7	112.7	115.7	152.7	152	0.7	6
	30	<input type="checkbox"/>	MSL0380-L30C	114.7	132.7	135.7	172.7	172	0.7	6
3.9	20	<input type="checkbox"/>	MSL0390-L20C	78.7	92.7	95.7	132.7	132	0.7	6
	25	<input type="checkbox"/>	MSL0390-L25C	98.2	112.7	115.7	152.7	152	0.7	6
	30	<input type="checkbox"/>	MSL0390-L30C	117.7	132.7	135.7	172.7	172	0.7	6
4.0	20	<input type="checkbox"/>	MSL0400-L20C	80.7	92.7	95.7	132.7	132	0.7	6
	25	<input type="checkbox"/>	MSL0400-L25C	100.7	112.7	115.7	152.7	152	0.7	6
	30	<input type="checkbox"/>	MSL0400-L30C	120.7	132.7	135.7	172.7	172	0.7	6
4.1	20	<input type="checkbox"/>	MSL0410-L20C	82.7	104.7	107.7	144.7	144	0.7	6
	25	<input type="checkbox"/>	MSL0410-L25C	103.2	126.7	129.7	166.7	166	0.7	6
	30	<input type="checkbox"/>	MSL0410-L30C	123.7	149.7	152.7	189.7	189	0.7	6
4.2	20	<input type="checkbox"/>	MSL0420-L20C	84.8	104.8	107.8	144.8	144	0.8	6
	25	<input type="checkbox"/>	MSL0420-L25C	105.8	126.8	129.8	166.8	166	0.8	6
	30	<input type="checkbox"/>	MSL0420-L30C	126.8	149.8	152.8	189.8	189	0.8	6
4.3	20	<input type="checkbox"/>	MSL0430-L20C	86.8	104.8	107.8	144.8	144	0.8	6
	25	<input type="checkbox"/>	MSL0430-L25C	108.3	126.8	129.8	166.8	166	0.8	6
	30	<input type="checkbox"/>	MSL0430-L30C	129.8	149.8	152.8	189.8	189	0.8	6

DC (mm)	Głębokość otworu (L/D)	VP15TF	Numer zamówieniowy	Wymiary (mm)						
				LU	LCF	LH	OAL	LF	PL	DCON
4.4	20	<input type="checkbox"/>	MSL0440-L20C	88.8	104.8	107.8	144.8	144	0.8	6
	25	<input type="checkbox"/>	MSL0440-L25C	110.8	126.8	129.8	166.8	166	0.8	6
	30	<input type="checkbox"/>	MSL0440-L30C	132.8	149.8	152.8	189.8	189	0.8	6
4.5	20	<input type="checkbox"/>	MSL0450-L20C	90.8	104.8	107.8	144.8	144	0.8	6
	25	<input type="checkbox"/>	MSL0450-L25C	113.3	126.8	129.8	166.8	166	0.8	6
	30	<input type="checkbox"/>	MSL0450-L30C	135.8	149.8	152.8	189.8	189	0.8	6
4.6	20	<input type="checkbox"/>	MSL0460-L20C	92.8	115.8	118.8	155.8	155	0.8	6
	25	<input type="checkbox"/>	MSL0460-L25C	115.8	140.8	143.8	180.8	180	0.8	6
	30	<input type="checkbox"/>	MSL0460-L30C	138.8	165.8	168.8	205.8	205	0.8	6
4.7	20	<input type="checkbox"/>	MSL0470-L20C	94.9	115.9	118.9	155.9	155	0.9	6
	25	<input type="checkbox"/>	MSL0470-L25C	118.4	140.9	143.9	180.9	180	0.9	6
	30	<input type="checkbox"/>	MSL0470-L30C	141.9	165.9	168.9	205.9	205	0.9	6
4.8	20	<input type="checkbox"/>	MSL0480-L20C	96.9	115.9	118.9	155.9	155	0.9	6
	25	<input type="checkbox"/>	MSL0480-L25C	120.9	140.9	143.9	180.9	180	0.9	6
	30	<input type="checkbox"/>	MSL0480-L30C	144.9	165.9	168.9	205.9	205	0.9	6
4.9	20	<input type="checkbox"/>	MSL0490-L20C	98.9	115.9	118.9	155.9	155	0.9	6
	25	<input type="checkbox"/>	MSL0490-L25C	123.4	140.9	143.9	180.9	180	0.9	6
	30	<input type="checkbox"/>	MSL0490-L30C	147.9	165.9	168.9	205.9	205	0.9	6
5.0	20	<input type="checkbox"/>	MSL0500-L20C	100.9	115.9	118.9	155.9	155	0.9	6
	25	<input type="checkbox"/>	MSL0500-L25C	125.9	140.9	143.9	180.9	180	0.9	6
	30	<input type="checkbox"/>	MSL0500-L30C	150.9	165.9	168.9	205.9	205	0.9	6
5.1	20	<input type="checkbox"/>	MSL0510-L20C	102.9	127.9	130.9	167.9	167	0.9	6
	25	<input type="checkbox"/>	MSL0510-L25C	128.4	154.9	157.9	194.9	194	0.9	6
	30	<input type="checkbox"/>	MSL0510-L30C	153.9	182.9	185.9	222.9	222	0.9	6
5.2	20	<input type="checkbox"/>	MSL0520-L20C	104.9	127.9	130.9	167.9	167	0.9	6
	25	<input type="checkbox"/>	MSL0520-L25C	130.9	154.9	157.9	194.9	194	0.9	6
	30	<input type="checkbox"/>	MSL0520-L30C	156.9	182.9	185.9	222.9	222	0.9	6
5.3	20	<input type="checkbox"/>	MSL0530-L20C	107.0	128.0	131.0	168.0	167	1.0	6
	25	<input type="checkbox"/>	MSL0530-L25C	133.5	155.0	158.0	195.0	194	1.0	6
	30	<input type="checkbox"/>	MSL0530-L30C	160.0	183.0	186.0	223.0	222	1.0	6
5.4	20	<input type="checkbox"/>	MSL0540-L20C	109.0	128.0	131.0	168.0	167	1.0	6
	25	<input type="checkbox"/>	MSL0540-L25C	136.0	155.0	158.0	195.0	194	1.0	6
	30	<input type="checkbox"/>	MSL0540-L30C	163.0	183.0	186.0	223.0	222	1.0	6
5.5	20	<input type="checkbox"/>	MSL0550-L20C	111.0	128.0	131.0	168.0	167	1.0	6
	25	<input type="checkbox"/>	MSL0550-L25C	138.5	155.0	158.0	195.0	194	1.0	6
	30	<input type="checkbox"/>	MSL0550-L30C	166.0	183.0	186.0	223.0	222	1.0	6
5.6	20	<input type="checkbox"/>	MSL0560-L20C	113.0	139.0	142.0	179.0	178	1.0	6
	25	<input type="checkbox"/>	MSL0560-L25C	141.0	169.0	172.0	209.0	208	1.0	6
	30	<input type="checkbox"/>	MSL0560-L30C	169.0	199.0	202.0	239.0	238	1.0	6
5.7	20	<input type="checkbox"/>	MSL0570-L20C	115.0	139.0	142.0	179.0	178	1.0	6
	25	<input type="checkbox"/>	MSL0570-L25C	143.5	169.0	172.0	209.0	208	1.0	6
	30	<input type="checkbox"/>	MSL0570-L30C	172.0	199.0	202.0	239.0	238	1.0	6



Prosimy o natychmiastową zmianę wszystkich nadchodzących zamówień, obejmujących pozycje zaznaczone na szaro (MPS, MSL) na serię MPS1. Produkcja serii MPS i MSL jest wygaszana i od marca 2023 zostanie całkowicie zakończona.

: Niestandardowy, produkowany na specjalne zamówienie.

DC (mm)	Głębokość otworu (L/D)	VP15TF	Numer zamówieniowy	Wymiary (mm)						
				LU	LCF	LH	OAL	LF	PL	DCON
5.8	20	□	MSL0580-L20C	117.1	139.1	142.1	179.1	178	1.1	6
	25	□	MSL0580-L25C	146.1	169.1	172.1	209.1	208	1.1	6
	30	□	MSL0580-L30C	175.1	199.1	202.1	239.1	238	1.1	6
5.9	20	□	MSL0590-L20C	119.1	139.1	142.1	179.1	178	1.1	6
	25	□	MSL0590-L25C	148.6	169.1	172.1	209.1	208	1.1	6
	30	□	MSL0590-L30C	178.1	199.1	202.1	239.1	238	1.1	6
6.0	20	□	MSL0600-L20C	121.1	139.1	142.1	179.1	178	1.1	6
	25	□	MSL0600-L25C	151.1	169.1	172.1	209.1	208	1.1	6
	30	□	MSL0600-L30C	181.1	199.1	202.1	239.1	238	1.1	6
6.1	20	□	MSL0610-L20C	123.1	151.1	154.1	191.1	190	1.1	8
	25	□	MSL0610-L25C	153.6	183.1	186.1	223.1	222	1.1	8
	30	□	MSL0610-L30C	184.1	216.1	219.1	256.1	255	1.1	8
6.2	20	□	MSL0620-L20C	125.1	151.1	154.1	191.1	190	1.1	8
	25	□	MSL0620-L25C	156.1	183.1	186.1	223.1	222	1.1	8
	30	□	MSL0620-L30C	187.1	216.1	219.1	256.1	255	1.1	8
6.3	20	□	MSL0630-L20C	127.1	151.1	154.1	191.1	190	1.1	8
	25	□	MSL0630-L25C	158.6	183.1	186.1	223.1	222	1.1	8
	30	□	MSL0630-L30C	190.1	216.1	219.1	256.1	255	1.1	8
6.4	20	□	MSL0640-L20C	129.2	151.2	154.2	191.2	190	1.2	8
	25	□	MSL0640-L25C	161.2	183.2	186.2	223.2	222	1.2	8
	30	□	MSL0640-L30C	193.2	216.2	219.2	256.2	255	1.2	8
6.5	20	□	MSL0650-L20C	131.2	151.2	154.2	191.2	190	1.2	8
	25	□	MSL0650-L25C	163.7	183.2	186.2	223.2	222	1.2	8
	30	□	MSL0650-L30C	196.2	216.2	219.2	256.2	255	1.2	8
6.6	20	□	MSL0660-L20C	133.2	162.2	165.2	202.2	201	1.2	8
	25	□	MSL0660-L25C	166.2	197.2	200.2	237.2	236	1.2	8
	30	□	MSL0660-L30C	199.2	232.2	235.2	272.2	271	1.2	8
6.7	20	□	MSL0670-L20C	135.2	162.2	165.2	202.2	201	1.2	8
	25	□	MSL0670-L25C	168.7	197.2	200.2	237.2	236	1.2	8
	30	□	MSL0670-L30C	202.2	232.2	235.2	272.2	271	1.2	8
6.8	20	□	MSL0680-L20C	137.2	162.2	165.2	202.2	201	1.2	8
	25	□	MSL0680-L25C	171.2	197.2	200.2	237.2	236	1.2	8
	30	□	MSL0680-L30C	205.2	232.2	235.2	272.2	271	1.2	8
6.9	20	□	MSL0690-L20C	139.3	162.3	165.3	202.3	201	1.3	8
	25	□	MSL0690-L25C	173.8	197.3	200.3	237.3	236	1.3	8
	30	□	MSL0690-L30C	208.3	232.3	235.3	272.3	271	1.3	8
7.0	20	□	MSL0700-L20C	141.3	162.3	165.3	202.3	201	1.3	8
	25	□	MSL0700-L25C	176.3	197.3	200.3	237.3	236	1.3	8
	30	□	MSL0700-L30C	211.3	232.3	235.3	272.3	271	1.3	8
7.1	20	□	MSL0710-L20C	143.3	174.3	177.3	214.3	213	1.3	8
	25	□	MSL0710-L25C	178.8	211.3	214.3	251.3	250	1.3	8
	30	□	MSL0710-L30C	214.3	249.3	252.3	289.3	288	1.3	8
7.2	20	□	MSL0720-L20C	145.3	174.3	177.3	214.3	213	1.3	8
	25	□	MSL0720-L25C	181.3	211.3	214.3	251.3	250	1.3	8
	30	□	MSL0720-L30C	217.3	249.3	252.3	289.3	288	1.3	8
7.3	20	□	MSL0730-L20C	147.3	174.3	177.3	214.3	213	1.3	8
	25	□	MSL0730-L25C	183.8	211.3	214.3	251.3	250	1.3	8
	30	□	MSL0730-L30C	220.3	249.3	252.3	289.3	288	1.3	8
7.4	20	□	MSL0740-L20C	149.3	174.3	177.3	214.3	213	1.3	8
	25	□	MSL0740-L25C	186.3	211.3	214.3	251.3	250	1.3	8
	30	□	MSL0740-L30C	223.3	249.3	252.3	289.3	288	1.3	8
7.5	20	□	MSL0750-L20C	151.4	174.4	177.4	214.4	213	1.4	8
	25	□	MSL0750-L25C	188.9	211.4	214.4	251.4	250	1.4	8
	30	□	MSL0750-L30C	226.4	249.4	252.4	289.4	288	1.4	8

DC (mm)	Głębokość otworu (L/D)	VP15TF	Numer zamówieniowy	Wymiary (mm)						
				LU	LCF	LH	OAL	LF	PL	DCON
7.6	20	□	MSL0760-L20C	153.4	185.4	188.4	225.4	224	1.4	8
	25	□	MSL0760-L25C	191.4	225.4	228.4	265.4	264	1.4	8
	30	□	MSL0760-L30C	229.4	265.4	268.4	305.4	304	1.4	8
7.7	20	□	MSL0770-L20C	155.4	185.4	188.4	225.4	224	1.4	8
	25	□	MSL0770-L25C	193.9	225.4	228.4	265.4	264	1.4	8
	30	□	MSL0770-L30C	232.4	265.4	268.4	305.4	304	1.4	8
7.8	20	□	MSL0780-L20C	157.4	185.4	188.4	225.4	224	1.4	8
	25	□	MSL0780-L25C	196.4	225.4	228.4	265.4	264	1.4	8
	30	□	MSL0780-L30C	235.4	265.4	268.4	305.4	304	1.4	8
7.9	20	□	MSL0790-L20C	159.4	185.4	188.4	225.4	224	1.4	8
	25	□	MSL0790-L25C	198.9	225.4	228.4	265.4	264	1.4	8
	30	□	MSL0790-L30C	238.4	265.4	268.4	305.4	304	1.4	8
8.0	20	□	MSL0800-L20C	161.5	185.5	188.5	225.5	224	1.5	8
	25	□	MSL0800-L25C	201.5	225.5	228.5	265.5	264	1.5	8
	30	□	MSL0800-L30C	241.5	265.5	268.5	305.5	304	1.5	8
8.1	20	□	MSL0810-L20C	163.5	197.5	200.5	241.5	240	1.5	10
	25	□	MSL0810-L25C	204.0	239.5	242.5	283.5	282	1.5	10
	30	□	MSL0810-L30C	244.5	281.5	284.5	325.5	324	1.5	10
8.2	20	□	MSL0820-L20C	165.5	197.5	200.5	241.5	240	1.5	10
	25	□	MSL0820-L25C	206.5	239.5	242.5	283.5	282	1.5	10
	30	□	MSL0820-L30C	247.5	281.5	284.5	325.5	324	1.5	10
8.3	20	□	MSL0830-L20C	167.5	197.5	200.5	241.5	240	1.5	10
	25	□	MSL0830-L25C	209.0	239.5	242.5	283.5	282	1.5	10
	30	□	MSL0830-L30C	250.5	281.5	284.5	325.5	324	1.5	10
8.4	20	□	MSL0840-L20C	169.5	197.5	200.5	241.5	240	1.5	10
	25	□	MSL0840-L25C	211.5	239.5	242.5	283.5	282	1.5	10
	30	□	MSL0840-L30C	253.5	281.5	284.5	325.5	324	1.5	10
8.5	20	□	MSL0850-L20C	171.5	197.5	200.5	241.5	240	1.5	10
	25	□	MSL0850-L25C	214.0	239.5	242.5	283.5	282	1.5	10
	30	□	MSL0850-L30C	256.5	281.5	284.5	325.5	324	1.5	10
8.6	20	□	MSL0860-L20C	173.6	208.6	211.6	252.6	251	1.6	10
	25	□	MSL0860-L25C	216.6	253.6	256.6	297.6	296	1.6	10
	30	□	MSL0860-L30C	259.6	297.6	300.6	341.6	340	1.6	10
8.7	20	□	MSL0870-L20C	175.6	208.6	211.6	252.6	251	1.6	10
	25	□	MSL0870-L25C	219.1	253.6	256.6	297.6	296	1.6	10
	30	□	MSL0870-L30C	262.6	297.6	300.6	341.6	340	1.6	10
8.8	20	□	MSL0880-L20C	177.6	208.6	211.6	252.6	251	1.6	10
	25	□	MSL0880-L25C	221.6	253.6	256.6	297.6	296	1.6	10
	30	□	MSL0880-L30C	265.6	297.6	300.6	341.6	340	1.6	10
8.9	20	□	MSL0890-L20C	179.6	208.6	211.6	252.6	251	1.6	10
	25	□	MSL0890-L25C	224.1	253.6	256.6	297.6	296	1.6	10
	30	□	MSL0890-L30C	268.6	297.6	300.6	341.6	340	1.6	10
9.0	20	□	MSL0900-L20C	181.6	208.6	211.6	252.6	251	1.6	10
	25	□	MSL0900-L25C	226.6	253.6	256.6	297.6	296	1.6	10
	30	□	MSL0900-L30C	271.6	297.6	300.6	341.6	340	1.6	10
9.1	20	□	MSL0910-L20C	183.7	220.7	223.7	264.7	263	1.7	10
	25	□	MSL0910-L25C	229.2	267.7	270.7	311.7	310	1.7	10
	30	□	MSL0910-L30C	274.7	315.7	318.7	359.7	358	1.7	10
9.2	20	□	MSL0920-L20C	185.7	220.7	223.7	264.7	263	1.7	10
	25	□	MSL0920-L25C	231.7	267.7	270.7	311.7	310	1.7	10
	30	□	MSL0920-L30C	277.7	315.7	318.7	359.7	358	1.7	10
9.3	20	□	MSL0930-L20C	187.7	220.7	223.7	264.7	263	1.7	10
	25	□	MSL0930-L25C	234.2	267.7	270.7	311.7	310	1.7	10
	30	□	MSL0930-L30C	280.7	315.7	318.7	359.7	358	1.7	10

WIERCENIE (WIERTŁA PEŁNOWĘGLIKOWE)

MSL

Wiertła z łysinką standardową, super długie

WĘGLIKI
SPIEKANE

M

WIERCENIE

DC (mm)	Głębokość otworu (L/D)	VP15TF	Numer zamówieniowy	Wymiary (mm)						
				LU	LCF	LH	OAL	LF	PL	DCON
9.4	20	<input type="checkbox"/>	MSL0940-L20C	189.7	220.7	223.7	264.7	263	1.7	10
	25	<input type="checkbox"/>	MSL0940-L25C	236.7	267.7	270.7	311.7	310	1.7	10
	30	<input type="checkbox"/>	MSL0940-L30C	283.7	315.7	318.7	359.7	358	1.7	10
9.5	20	<input type="checkbox"/>	MSL0950-L20C	191.7	220.7	223.7	264.7	263	1.7	10
	25	<input type="checkbox"/>	MSL0950-L25C	239.2	267.7	270.7	311.7	310	1.7	10
	30	<input type="checkbox"/>	MSL0950-L30C	286.7	315.7	318.7	359.7	358	1.7	10
9.6	20	<input type="checkbox"/>	MSL0960-L20C	193.7	231.7	234.7	275.7	274	1.7	10
	25	<input type="checkbox"/>	MSL0960-L25C	241.7	281.7	284.7	325.7	324	1.7	10
	30	<input type="checkbox"/>	MSL0960-L30C	289.7	331.7	334.7	375.7	374	1.7	10
9.7	20	<input type="checkbox"/>	MSL0970-L20C	195.8	231.8	234.8	275.8	274	1.8	10
	25	<input type="checkbox"/>	MSL0970-L25C	244.3	281.8	284.8	325.8	324	1.8	10
	30	<input type="checkbox"/>	MSL0970-L30C	292.8	331.8	334.8	375.8	374	1.8	10
9.8	20	<input type="checkbox"/>	MSL0980-L20C	197.8	231.8	234.8	275.8	274	1.8	10
	25	<input type="checkbox"/>	MSL0980-L25C	246.8	281.8	284.8	325.8	324	1.8	10
	30	<input type="checkbox"/>	MSL0980-L30C	295.8	331.8	334.8	375.8	374	1.8	10
9.9	20	<input type="checkbox"/>	MSL0990-L20C	199.8	231.8	234.8	275.8	274	1.8	10
	25	<input type="checkbox"/>	MSL0990-L25C	249.3	281.8	284.8	325.8	324	1.8	10
	30	<input type="checkbox"/>	MSL0990-L30C	298.8	331.8	334.8	375.8	374	1.8	10
10.0	20	<input type="checkbox"/>	MSL1000-L20C	201.8	231.8	234.8	275.8	274	1.8	10
	25	<input type="checkbox"/>	MSL1000-L25C	251.8	281.8	284.8	325.8	324	1.8	10
	30	<input type="checkbox"/>	MSL1000-L30C	301.8	331.8	334.8	375.8	374	1.8	10
10.1	20	<input type="checkbox"/>	MSL1010-L20C	203.8	243.8	246.8	292.8	291	1.8	12
	25	<input type="checkbox"/>	MSL1010-L25C	254.3	295.8	298.8	344.8	343	1.8	12
10.2	20	<input type="checkbox"/>	MSL1020-L20C	205.9	243.9	246.9	292.9	291	1.9	12
	25	<input type="checkbox"/>	MSL1020-L25C	256.9	295.9	298.9	344.9	343	1.9	12
10.3	20	<input type="checkbox"/>	MSL1030-L20C	207.9	243.9	246.9	292.9	291	1.9	12
	25	<input type="checkbox"/>	MSL1030-L25C	259.4	295.9	298.9	344.9	343	1.9	12
10.4	20	<input type="checkbox"/>	MSL1040-L20C	209.9	243.9	246.9	292.9	291	1.9	12
	25	<input type="checkbox"/>	MSL1040-L25C	261.9	295.9	298.9	344.9	343	1.9	12
10.5	20	<input type="checkbox"/>	MSL1050-L20C	211.9	243.9	246.9	292.9	291	1.9	12
	25	<input type="checkbox"/>	MSL1050-L25C	264.4	295.9	298.9	344.9	343	1.9	12
10.6	20	<input type="checkbox"/>	MSL1060-L20C	213.9	254.9	257.9	303.9	302	1.9	12
	25	<input type="checkbox"/>	MSL1060-L25C	266.9	309.9	312.9	358.9	357	1.9	12
10.7	20	<input type="checkbox"/>	MSL1070-L20C	215.9	254.9	257.9	303.9	302	1.9	12
	25	<input type="checkbox"/>	MSL1070-L25C	269.4	309.9	312.9	358.9	357	1.9	12
10.8	20	<input type="checkbox"/>	MSL1080-L20C	218.0	255.0	258.0	304.0	302	2.0	12
	25	<input type="checkbox"/>	MSL1080-L25C	272.0	310.0	313.0	359.0	357	2.0	12
10.9	20	<input type="checkbox"/>	MSL1090-L20C	220.0	255.0	258.0	304.0	302	2.0	12
	25	<input type="checkbox"/>	MSL1090-L25C	274.5	310.0	313.0	359.0	357	2.0	12
11.0	20	<input type="checkbox"/>	MSL1100-L20C	222.0	255.0	258.0	304.0	302	2.0	12
	25	<input type="checkbox"/>	MSL1100-L25C	277.0	310.0	313.0	359.0	357	2.0	12
11.1	20	<input type="checkbox"/>	MSL1110-L20C	224.0	267.0	270.0	316.0	314	2.0	12
	25	<input type="checkbox"/>	MSL1110-L25C	279.5	324.0	327.0	373.0	371	2.0	12
11.2	20	<input type="checkbox"/>	MSL1120-L20C	226.0	267.0	270.0	316.0	314	2.0	12
	25	<input type="checkbox"/>	MSL1120-L25C	282.0	324.0	327.0	373.0	371	2.0	12
11.3	20	<input type="checkbox"/>	MSL1130-L20C	228.1	267.1	270.1	316.1	314	2.1	12
	25	<input type="checkbox"/>	MSL1130-L25C	284.6	324.1	327.1	373.1	371	2.1	12
11.4	20	<input type="checkbox"/>	MSL1140-L20C	230.1	267.1	270.1	316.1	314	2.1	12
	25	<input type="checkbox"/>	MSL1140-L25C	287.1	324.1	327.1	373.1	371	2.1	12
11.5	20	<input type="checkbox"/>	MSL1150-L20C	232.1	267.1	270.1	316.1	314	2.1	12
	25	<input type="checkbox"/>	MSL1150-L25C	289.6	324.1	327.1	373.1	371	2.1	12
11.6	20	<input type="checkbox"/>	MSL1160-L20C	234.1	278.1	281.1	327.1	325	2.1	12
	25	<input type="checkbox"/>	MSL1160-L25C	292.1	338.1	341.1	387.1	385	2.1	12

DC (mm)	Głębokość otworu (L/D)	VP15TF	Numer zamówieniowy	Wymiary (mm)						
				LU	LCF	LH	OAL	LF	PL	DCON
11.7	20	<input type="checkbox"/>	MSL1170-L20C	236.1	278.1	281.1	327.1	325	2.1	12
	25	<input type="checkbox"/>	MSL1170-L25C	294.6	338.1	341.1	387.1	385	2.1	12
11.8	20	<input type="checkbox"/>	MSL1180-L20C	238.1	278.1	281.1	327.1	325	2.1	12
	25	<input type="checkbox"/>	MSL1180-L25C	297.1	338.1	341.1	387.1	385	2.1	12
11.9	20	<input type="checkbox"/>	MSL1190-L20C	240.2	278.2	281.2	327.2	325	2.2	12
	25	<input type="checkbox"/>	MSL1190-L25C	299.7	338.2	341.2	387.2	385	2.2	12
12.0	20	<input type="checkbox"/>	MSL1200-L20C	242.2	278.2	281.2	327.2	325	2.2	12
	25	<input type="checkbox"/>	MSL1200-L25C	302.2	338.2	341.2	387.2	385	2.2	12
12.1	20	<input type="checkbox"/>	MSL1210-L20C	244.2	290.2	293.2	339.2	337	2.2	14
12.2	20	<input type="checkbox"/>	MSL1220-L20C	246.2	290.2	293.2	339.2	337	2.2	14
12.3	20	<input type="checkbox"/>	MSL1230-L20C	248.2	290.2	293.2	339.2	337	2.2	14
12.4	20	<input type="checkbox"/>	MSL1240-L20C	250.3	290.3	293.3	339.3	337	2.3	14
12.5	20	<input type="checkbox"/>	MSL1250-L20C	252.3	290.3	293.3	339.3	337	2.3	14
12.6	20	<input type="checkbox"/>	MSL1260-L20C	254.3	301.3	304.3	350.3	348	2.3	14
12.7	20	<input type="checkbox"/>	MSL1270-L20C	256.3	301.3	304.3	350.3	348	2.3	14
12.8	20	<input type="checkbox"/>	MSL1280-L20C	258.3	301.3	304.3	350.3	348	2.3	14
12.9	20	<input type="checkbox"/>	MSL1290-L20C	260.3	301.3	304.3	350.3	348	2.3	14
13.0	20	<input type="checkbox"/>	MSL1300-L20C	262.4	301.4	304.4	350.4	348	2.4	14
13.1	20	<input type="checkbox"/>	MSL1310-L20C	264.4	313.4	316.4	362.4	360	2.4	14
13.2	20	<input type="checkbox"/>	MSL1320-L20C	266.4	313.4	316.4	362.4	360	2.4	14
13.3	20	<input type="checkbox"/>	MSL1330-L20C	268.4	313.4	316.4	362.4	360	2.4	14
13.4	20	<input type="checkbox"/>	MSL1340-L20C	270.4	313.4	316.4	362.4	360	2.4	14
13.5	20	<input type="checkbox"/>	MSL1350-L20C	272.5	313.5	316.5	362.5	360	2.5	14
13.6	20	<input type="checkbox"/>	MSL1360-L20C	274.5	324.5	327.5	373.5	371	2.5	14
13.7	20	<input type="checkbox"/>	MSL1370-L20C	276.5	324.5	327.5	373.5	371	2.5	14
13.8	20	<input type="checkbox"/>	MSL1380-L20C	278.5	324.5	327.5	373.5	371	2.5	14
13.9	20	<input type="checkbox"/>	MSL1390-L20C	280.5	324.5	327.5	373.5	371	2.5	14
14.0	20	<input type="checkbox"/>	MSL1400-L20C	282.5	324.5	327.5	373.5	371	2.5	14

: Niestandardowy, produkowany na specjalne zamówienie.

ZALECANE PARAMETRY SKRAWANIA

● WIERTŁA MPS (3xDC, 5xDC, 8xDC, 12xDC)

Materiał przedmiotu obrabianego	Średnica wiertła Parametry Twardość	φ 3.0 – φ 6.0		φ 6.0 – φ 10.0		φ 10.0 – φ 14.0		φ 14.0 – φ 20.0	
		Prędkość skrawania (m/min)	Posuw (mm/obr.)	Prędkość skrawania (m/min)	Posuw (mm/obr.)	Prędkość skrawania (m/min)	Posuw (mm/obr.)	Prędkość skrawania (m/min)	Posuw (mm/obr.)
P Stal konstrukcyjna	≤180HB	110 (50–120)	0.20 (0.15–0.25)	130 (80–140)	0.25 (0.20–0.35)	150 (90–170)	0.30 (0.20–0.40)	160 (100–180)	0.35 (0.20–0.40)
	180–280HB	90 (50–100)	0.20 (0.15–0.25)	110 (70–120)	0.25 (0.20–0.35)	130 (80–140)	0.25 (0.20–0.40)	140 (100–150)	0.30 (0.20–0.40)
	280–350HB	80 (40–90)	0.20 (0.15–0.30)	90 (60–110)	0.25 (0.15–0.30)	110 (70–130)	0.25 (0.15–0.40)	120 (90–140)	0.30 (0.20–0.40)
M Stal nierdzewna	≤200HB	50 (20–100)	0.10 (0.05–0.15)	60 (40–120)	0.20 (0.10–0.25)	70 (50–120)	0.25 (0.15–0.30)	80 (60–120)	0.25 (0.15–0.30)
K Żeliwo	Wytrzymałość na rozciąganie ≤350MPa	100 (70–120)	0.25 (0.15–0.30)	130 (100–140)	0.30 (0.20–0.35)	150 (110–160)	0.35 (0.25–0.40)	160 (120–170)	0.35 (0.25–0.40)
	Wytrzymałość na rozciąganie ≤450MPa	60 (30–80)	0.20 (0.15–0.25)	70 (40–90)	0.20 (0.15–0.30)	90 (50–110)	0.25 (0.20–0.40)	100 (60–110)	0.3 (0.20–0.40)
S Stop żaroodporny	–	20 (10–25)	0.10 (0.05–0.15)	25 (15–30)	0.12 (0.05–0.15)	25 (15–30)	0.15 (0.10–0.20)	30 (25–35)	0.15 (0.10–0.20)

● WIERTŁA MPS (L/D=15–30), WIERTŁA MSL (L/D=20–30)

Materiał przedmiotu obrabianego	Średnica wiertła Parametry Twardość	φ 3.0 – φ 6.0		φ 6.0 – φ 10.0		φ 10.0 – φ 14.0	
		Prędkość skrawania (m/min)	Posuw (mm/obr.)	Prędkość skrawania (m/min)	Posuw (mm/obr.)	Prędkość skrawania (m/min)	Posuw (mm/obr.)
P Stal konstrukcyjna	≤180HB	85 (35–100)	0.20 (0.15–0.25)	85 (45–120)	0.25 (0.15–0.35)	90 (55–120)	0.30 (0.20–0.35)
	180–280HB	80 (40–95)	0.20 (0.15–0.25)	90 (50–120)	0.25 (0.20–0.35)	90 (60–130)	0.30 (0.15–0.35)
	280–350HB	75 (35–80)	0.15 (0.15–0.20)	80 (45–115)	0.20 (0.15–0.25)	85 (55–115)	0.25 (0.15–0.30)
M Stal nierdzewna	≤200HB	50 (20–80)	0.10 (0.05–0.15)	60 (20–90)	0.12 (0.05–0.15)	70 (20–90)	0.15 (0.10–0.20)
K Żeliwo	Wytrzymałość na rozciąganie ≤350MPa	70 (40–85)	0.25 (0.15–0.30)	75 (50–90)	0.30 (0.20–0.35)	80 (50–95)	0.35 (0.20–0.40)
	Wytrzymałość na rozciąganie ≤450MPa	65 (35–80)	0.20 (0.15–0.25)	70 (45–85)	0.25 (0.15–0.30)	75 (45–90)	0.30 (0.20–0.35)
S Stop żaroodporny	–	20 (10–25)	0.10 (0.05–0.15)	25 (15–30)	0.12 (0.05–0.15)	25 (15–30)	0.15 (0.10–0.20)

● WIERTŁA MPS (L/D=35–40)

Materiał przedmiotu obrabianego	Średnica wiertła Parametry Twardość	φ 3.0 – φ 4.0		φ 5.0 – φ 6.0		φ 6.0 – φ 9.0	
		Prędkość skrawania (m/min)	Posuw (mm/obr.)	Prędkość skrawania (m/min)	Posuw (mm/obr.)	Prędkość skrawania (m/min)	Posuw (mm/obr.)
P Stal konstrukcyjna	≤180HB	60 (50–70)	0.18 (0.13–0.20)	70 (55–80)	0.20 (0.15–0.23)	75 (60–85)	0.25 (0.18–0.28)
	180–280HB	55 (40–65)	0.15 (0.10–0.18)	65 (45–75)	0.18 (0.13–0.22)	70 (55–80)	0.23 (0.15–0.25)
	280–350HB	50 (40–60)	0.12 (0.08–0.15)	55 (40–65)	0.17 (0.13–0.20)	60 (40–75)	0.20 (0.15–0.23)
M Stal nierdzewna	≤200HB	35 (30–45)	0.10 (0.07–0.15)	40 (30–50)	0.12 (0.08–0.15)	45 (30–60)	0.15 (0.13–0.20)
K Żeliwo	Wytrzymałość na rozciąganie ≤350MPa	55 (35–70)	0.15 (0.10–0.20)	60 (40–65)	0.20 (0.15–0.23)	60 (45–70)	0.23 (0.18–0.28)
	Wytrzymałość na rozciąganie ≤450MPa	45 (30–60)	0.12 (0.08–0.15)	50 (40–60)	0.17 (0.13–0.20)	55 (40–65)	0.20 (0.15–0.23)
S Stop żaroodporny	–	15 (10–25)	0.07 (0.05–0.10)	20 (10–25)	0.07 (0.05–0.10)	20 (10–25)	0.10 (0.06–0.12)

Parametry wiercenia mogą różnić się znacznie, powyższą tabelę należy traktować jedynie jako punkt wyjścia i dobrać parametry stosownie do warunków obróbki.

Dla wiertel o długości większej od L/D=10 zaleca się wywiercenie otworu wstępnego.



Prosimy o natychmiastową zmianę wszystkich nadchodzących zamówień, obejmujących pozycje zaznaczone na szaro (MPS, MSL) na serię MPS1. Produkcja serii MPS i MSL jest wygaszana i od marca 2023 zostanie całkowicie zakończona.

WIERCENIE ZA POMOCĄ WIERTEŁ DŁUGICH TYPU MPS/MSL

WIERCENIE PRZEDMIOTÓW O PŁASKIEJ POWIERZCHNI CZOŁOWEJ ●Wiercenie otworu nieprzelotowego

1. Wiercenie otworu pilotowego

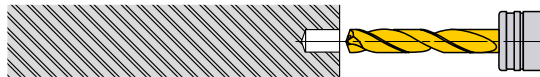

- ① Użyć wiertła o większym kącie wierzchołkowym (bardziej płaskiego), niż dla wiertła super długiego. Użyć wiertła o możliwie najkrótszym rowku wiórowym.
- ② Zapewnić wykonanie wysokodokładnego otworu pilotowego, aby proces wiercenia głębokich otworów przebiegał bez problemów
- ③ Głębokość wiercenia otworu pilotowego: ok. 1DC albo większa. (Głębokość otworu pilotowego dostosować do długości wiertła.)

2. Wiercenie wstępne wiertłem długim



- ① Wiercić wstępnie otwór pilotowy przy małych obrotach. (Obroty 1000min^{-1} , posuw $0.2-0.3\text{mm/obr}$)
- ② Zakończyć wiercenie wiertłem do głębokich otworów na $0.5-1\text{mm}$ przed dnem otworu pilotowego.

3. Wiercenie głębokiego otworu

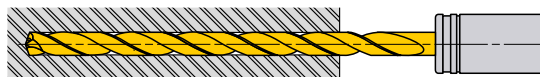

- ① Zwiększyć obroty i posuw w jednym cyklu i wiercić, aż do uzyskania żądanej głębokości otworu.

4. Wycofanie wiertła

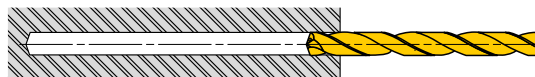

- ① Po wierceniu zmniejszyć obroty na $0.5-1\text{mm}$ przed końcem otworu. (Obroty około 1000min^{-1})
- ② Wycofać wiertło na głębokość początkową otworu pilotowego przy prędkości posuwu 3000mm/min .
- ③ Wycofać wiertło z otworu pilotowego przy obrotach ($n=300$, $V_f=3000\text{mm/min}$.)

WIERCENIE PRZERYWANE ●Wiercenie otworów w płaszczyznach nieregularnych lub pod kątem

1. Frezowanie pogłębienia prostopadłego do kierunku wiercenia



- ① Obrabiać płaską lub nieregularną powierzchnię frezem palcowym lub frezem do rowków wpustowych o tej samej średnicy, jak wymagana średnica otworu.

2. Wiercenie otworu pilotowego



- ① Użyć wiertła o większym kącie wierzchołkowym (bardziej płaskiego), niż dla wiertła super długiego. Użyć wiertła o możliwie najkrótszym rowku wiórowym.
- ② Zapewnić wykonanie wysokodokładnego otworu pilotowego, aby proces wiercenia głębokich otworów przebiegał bez problemów
- ③ Głębokość wiercenia otworu pilotowego: ok. 1DC albo większa. (Głębokość otworu pilotowego dostosować do długości wiertła.)

3. Wiercenie wstępne wiertłem długim



- ① Wprowadzić wiertło w otwór pilotowy przy małych obrotach (prędkość skrawania $20-30\text{m/min}$, posuw $0.2-0.3\text{mm/obr}$).
- ② Zatrzymać wiertło $1\text{mm}-3\text{mm}$ przed dnem otworu pilotowego.

4. Wiercenie głębokiego otworu

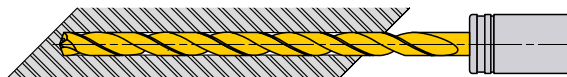

- ① Zwiększyć obroty i posuw w jednym cyklu i wiercić, aż do uzyskania żądanej głębokości otworu.

5. Wyjście z materiału

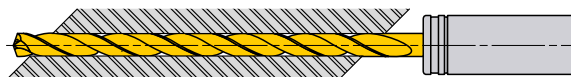

- ① Podczas wychodzenia z materiału istnieje niebezpieczeństwo uszkodzenia krawędzi skrawającej wiertła.
- ② W momencie wyjścia z materiału zmniejszyć posuw.

6. Wycofanie wiertła



- ① Wycofać wiertło do punktu początkowego otworu pilotowego przy prędkości posuwu 3000mm/min .



Prosimy o natychmiastową zmianę wszystkich nadchodzących zamówień, obejmujących pozycje zaznaczone na szaro (MPS, MSL) na serię MPS1. Produkcja serii MPS i MSL jest wygaszana i od marca 2023 zostanie całkowicie zakończona.

MICRO-MGS

- Do wiercenia głębokich otworów o bardzo małej średnicy.
- Tolerancja bicia zapewnia wysoką dokładność wiercenia.



WĘGLIKI
SPIEKANE



Chłodzenie wewnętrzne

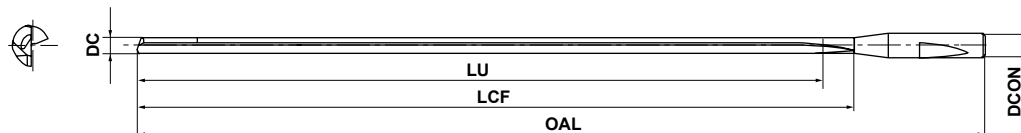

DC ≤ 3
$\begin{matrix} 0 \\ -0.005 \end{matrix}$

• Wiertła MGS można stosować z oprawkami termokurczliwymi.

DC (mm)	Głębokość otworu (L/D)	HT110	Numer zamówieniowy	Wymiary (mm)			
				LU	LCF	OAL	DCON
0.7	50	★	MGS0070L040B	35.0	40	80	3
	80	★	MGS0070L060B	56.0	60	100	3
0.8	45	★	MGS0080L040B	36.0	40	80	3
	70	★	MGS0080L060B	56.0	60	100	3
0.9	40	★	MGS0090L040B	36.0	40	80	3
	60	★	MGS0090L060B	54.0	60	100	3
1.0	35	★	MGS0100L040B	35.0	40	80	3
	55	★	MGS0100L060B	55.0	60	100	3
	75	★	MGS0100L080B	75.0	80	120	3
1.1	30	★	MGS0110L040B	33.0	40	80	3
	50	★	MGS0110L060B	55.0	60	100	3
	65	★	MGS0110L080B	71.5	80	120	3
1.2	30	★	MGS0120L040B	36.0	40	80	3
	45	★	MGS0120L060B	54.0	60	100	3
	60	★	MGS0120L080B	72.0	80	120	3
1.3	40	★	MGS0130L060B	52.0	60	100	3
	55	★	MGS0130L080B	71.5	80	120	3
	70	★	MGS0130L100B	91.0	100	140	3
1.4	35	★	MGS0140L060B	49.0	60	100	3
	50	★	MGS0140L080B	70.0	80	120	3
	65	★	MGS0140L100B	91.0	100	140	3
1.5	35	★	MGS0150L060B	52.5	60	100	3
	50	★	MGS0150L080B	75.0	80	120	3
	60	★	MGS0150L100B	90.0	100	140	3
1.6	30	★	MGS0160L060B	48.0	60	100	3
	45	★	MGS0160L080B	72.0	80	120	3
	55	★	MGS0160L100B	88.0	100	140	3
1.7	30	★	MGS0170L060B	51.0	60	100	3
	40	★	MGS0170L080B	68.0	80	120	3
	55	★	MGS0170L100B	93.5	100	140	3

DC (mm)	Głębokość otworu (L/D)	HT110	Numer zamówieniowy	Wymiary (mm)			
				LU	LCF	OAL	DCON
1.8	30	★	MGS0180L060B	54.0	60	100	3
	40	★	MGS0180L080B	72.0	80	120	3
	50	★	MGS0180L100B	90.0	100	140	3
1.9	25	★	MGS0190L060B	47.5	60	100	3
	35	★	MGS0190L080B	66.5	80	120	3
	45	★	MGS0190L100B	85.5	100	140	3
2.0	25	★	MGS0200L060B	50.0	60	100	3
	35	★	MGS0200L080B	70.0	80	120	3
	45	★	MGS0200L100B	90.0	100	140	3
2.1	35	★	MGS0210L080B	73.5	80	120	3
	40	★	MGS0210L100B	84.0	100	140	3
2.2	30	★	MGS0220L080B	66.0	80	120	3
	40	★	MGS0220L100B	88.0	100	140	3
2.3	30	★	MGS0230L080B	69.0	80	120	3
	40	★	MGS0230L100B	92.0	100	140	3
2.4	30	★	MGS0240L080B	72.0	80	120	3
	35	★	MGS0240L100B	84.0	100	140	3
2.5	25	★	MGS0250L080B	62.5	80	120	3
	35	★	MGS0250L100B	87.5	100	140	3
2.6	25	★	MGS0260L080B	65.0	80	120	3
	35	★	MGS0260L100B	91.0	100	140	3
2.7	25	★	MGS0270L080B	67.5	80	120	3
	30	★	MGS0270L100B	81.0	100	140	3
2.8	25	★	MGS0280L080B	70.0	80	120	3
	30	★	MGS0280L100B	84.0	100	140	3
2.9	20	★	MGS0290L080B	58.0	80	120	3
	30	★	MGS0290L100B	87.0	100	140	3
3.0	20	★	MGS0300L080B	60.0	80	120	3
	30	★	MGS0300L100B	90.0	100	140	3

Uwaga 1) W sprawie wiertel pokrywanych prosimy o skontaktowanie się z naszą firmą. (Węglik spiekany pokrywany **VP**, **GP** i **UP**).

★ : Na specjalne zamówienie z magazynu w Japonii.

PARAMETRY SKRAWANIA > L080
INFORMACJE TECHNICZNE > P001

M079

M

WIERCENIE

MICRO-MGS

WĘGLIKI
SPIEKANE

OPRAWKA

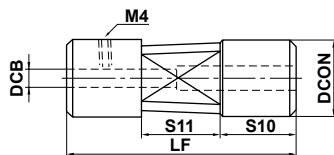

OPRAWKA

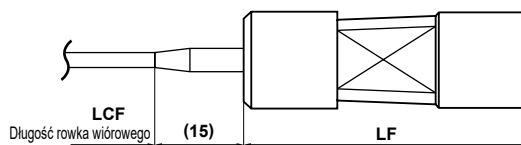

Numer zamówieniowy	Dostępność	Wymiary (mm)					Wkręt mocujący	Typ klucza
		DCON	DCB	LF	S10	S11		
MGD38	★	12.7	3.0	38.1	12.6	12.7	HSS04004	HKY20F
MGD70	★	12.7	3.0	70.0	25.0	20.0	HSS04004	HKY20F

ZALECANE PARAMETRY SKRAWANIA

Materiał przedmiotu obrabianego	P				P			
	Stal konstrukcyjna (≤180HB)	Stal węglowa Stal stopowa (180–280HB)						
Ck10	Ck45, 42CrMo4							
Typ chłodziwa	Chłodziwo nierozcieńczalne w wodzie				Chłodziwo nierozcieńczalne w wodzie			
Średnica wiertła DC (mm)	Prędkość skrawania (m/min)	Obroty (min ⁻¹)	Posuw (min.–maks.) (mm/obr.)	Posuw stołu (mm/min)	Prędkość skrawania (m/min)	Obroty (min ⁻¹)	Posuw (min.–maks.) (mm/obr.)	Posuw stołu (mm/min)
0.8	50	19800	0.01 (0.005–0.016)	195	40	15900	0.01 (0.005–0.016)	155
1.0	50	15900	0.01 (0.007–0.020)	155	40	12700	0.01 (0.007–0.020)	125
1.2	60	15900	0.015 (0.008–0.024)	235	50	13200	0.015 (0.008–0.024)	195
1.6	60	11900	0.02 (0.011–0.032)	235	50	9900	0.02 (0.011–0.032)	195
2.0	60	9500	0.025 (0.013–0.040)	235	50	7900	0.025 (0.013–0.040)	195
2.5	70	8900	0.03 (0.017–0.050)	265	60	7600	0.03 (0.017–0.050)	225
3.0	70	7400	0.04 (0.020–0.060)	295	60	6300	0.04 (0.020–0.060)	250

Materiał przedmiotu obrabianego	P				M			
	Stal węglowa Stal stopowa (280–350HB)	Austenityczna stal nierdzewna (≤200HB)						
36CrNiMo4	X5CrNi1810, X5CrNiMo17-12-2							
Typ chłodziwa	Chłodziwo nierozcieńczalne w wodzie				Chłodziwo nierozcieńczalne w wodzie			
Średnica wiertła DC (mm)	Prędkość skrawania (m/min)	Obroty (min ⁻¹)	Posuw (min.–maks.) (mm/obr.)	Posuw stołu (mm/min)	Prędkość skrawania (m/min)	Obroty (min ⁻¹)	Posuw (min.–maks.) (mm/obr.)	Posuw stołu (mm/min)
0.8	30	11900	0.005 (0.004–0.005)	55	30	11900	0.01 (0.005–0.016)	115
1.0	30	9500	0.005 (0.005–0.007)	45	30	9500	0.01 (0.007–0.020)	95
1.2	40	10600	0.005 (0.006–0.008)	50	30	7900	0.015 (0.008–0.024)	115
1.6	40	7900	0.01 (0.008–0.011)	75	40	7900	0.02 (0.011–0.032)	155
2.0	40	6300	0.01 (0.010–0.013)	60	40	6300	0.025 (0.013–0.040)	155
2.5	50	6300	0.015 (0.013–0.017)	90	40	5000	0.03 (0.017–0.050)	150
3.0	50	5300	0.015 (0.015–0.020)	75	40	4200	0.04 (0.020–0.060)	165

Materiał przedmiotu obrabianego	K				K			
	Żeliwo szare (≤350MPa)	Żeliwo sferoidalne (GGG) (≤450MPa)						
GG30	GGG45							
Typ chłodziwa	Chłodziwo nierozcieńczalne w wodzie • Chłodziwo wodorozcieńczalne				Chłodziwo nierozcieńczalne w wodzie • Chłodziwo wodorozcieńczalne			
Średnica wiertła DC (mm)	Prędkość skrawania (m/min)	Obroty (min ⁻¹)	Posuw (min.–maks.) (mm/obr.)	Posuw stołu (mm/min)	Prędkość skrawania (m/min)	Obroty (min ⁻¹)	Posuw (min.–maks.) (mm/obr.)	Posuw stołu (mm/min)
0.8	50	19800	0.01 (0.008–0.016)	195	40	15900	0.005 (0.005–0.008)	75
1.0	50	15900	0.015 (0.010–0.020)	235	40	12700	0.005 (0.007–0.010)	60
1.2	60	15900	0.015 (0.012–0.024)	235	50	13200	0.01 (0.008–0.012)	130
1.6	60	11900	0.02 (0.016–0.032)	235	50	9900	0.01 (0.011–0.016)	95
2.0	60	9500	0.03 (0.020–0.040)	285	50	7900	0.015 (0.013–0.020)	115
2.5	70	8900	0.035 (0.025–0.050)	310	60	7600	0.02 (0.017–0.025)	150
3.0	70	7400	0.045 (0.030–0.060)	330	60	6300	0.025 (0.020–0.030)	155

Uwaga 1) Ze względu na bezpieczeństwo i do skutecznego usuwania wióra zalecane jest użycie chłodziwa pod wysokim ciśnieniem. (Minimalne ciśnienie chłodziwa = 1000 PSI)

Uwaga 2) Do czyszczenia chłodziwa używać filtra o małym numerze siata (poniżej 5 µm).

Dokładne filtrowanie jest niezbędne, aby zapobiec zatkaniu kanałów doprowadzenia chłodziwa.

Uwaga 3) Wymagany jest otwór pilotowy lub tuleja prowadząca.

★ : Na specjalne zamówienie z magazynu w Japonii.

ZALECANE PARAMETRY SKRAWANIA

Materiał przedmiotu obrabianego	N				N			
	Stopy aluminium (Si<5%)				Miedź, Stopy miedzi			
Typ chłodziwa	Chłodziwo nierozcieńczalne w wodzie • Chłodziwo wodorozcieńczalne				Chłodziwo nierozcieńczalne w wodzie • Chłodziwo wodorozcieńczalne			
Średnica wiertła DC (mm)	Prędkość skrawania (m/min)	Obroty (min ⁻¹)	Posuw (min. – maks.) (mm/obr.)	Posuw stołu (mm/min)	Prędkość skrawania (m/min)	Obroty (min ⁻¹)	Posuw (min. – maks.) (mm/obr.)	Posuw stołu (mm/min)
0.8	50	19800	0.01 (0.008–0.016)	195	40	15900	0.01 (0.008–0.016)	155
1.0	60	19000	0.015 (0.010–0.020)	285	50	15900	0.015 (0.010–0.020)	235
1.2	70	18500	0.015 (0.012–0.024)	275	60	15900	0.015 (0.012–0.024)	235
1.6	80	15900	0.02 (0.016–0.032)	315	70	13900	0.02 (0.016–0.032)	275
2.0	90	14300	0.03 (0.020–0.040)	425	80	12700	0.03 (0.020–0.040)	380
2.5	100	12700	0.035 (0.025–0.050)	440	90	11400	0.035 (0.025–0.050)	395
3.0	100	10600	0.045 (0.030–0.060)	475	100	10600	0.045 (0.030–0.060)	475

Uwaga 1) Ze względu na bezpieczeństwo i do skutecznego usuwania wióra zalecane jest użycie chłodziwa pod wysokim ciśnieniem. (Minimalne ciśnienie chłodziwa = 70 bar)

Uwaga 2) Do czyszczenia chłodziwa używać filtra o małym numerze sita (poniżej 5 µm).

Dokładne filtrowanie jest niezbędne, aby zapobiec zatkaniu kanałów doprowadzenia chłodziwa.

Uwaga 3) Wymagany jest otwór pilotowy lub tuleja prowadząca.

SPOSÓB UŻYCIA

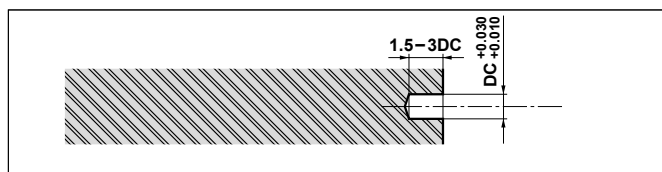

1. Wiercenie otworu prowadzącego.
(Zalecane jest użycie wiertła Mitsubishi MWE lub MWS).

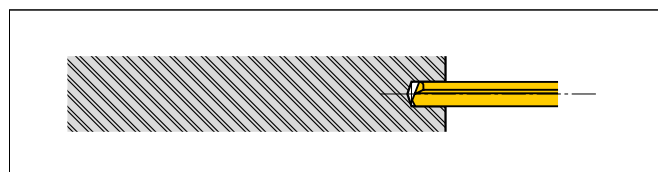

2. Wprowadzić wiertło w otwór pilotowy przy wyłączonych obrotach lub z przeciwnymi obrotami (poniżej 300 obr/min). Zatrzymać wiertło lufowe MGS 1 mm–2 mm przed dnem otworu pilotowego.

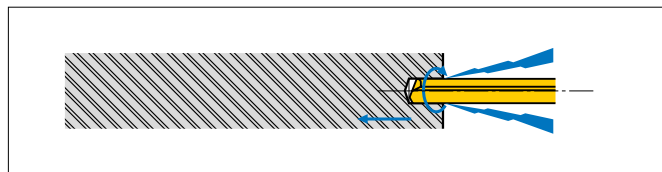

3. Włączyć dopływ chłodziwa, zwiększyć prędkość skrawania i posuw do uzyskania zalecanych parametrów i rozpocząć wiercenie.

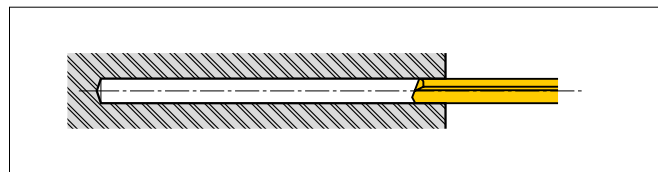

4. Po zakończeniu wiercenia wyciągnąć wiertło do pozycji wyjściowej (patrz Poz. 2) i wyłączyć obroty wiertła.

WIERCENIE (WIERTŁA PEŁNOWĘGLIKOWE)

MMS

- Stosowane do wysokowydajnego i dokładnego wiercenia w stalach nierdzewnych.
- Otwory trygonalne są wykonywane w wiertłach o średnicy od 4.60 mm.



WĘGLIKI SPIEKANE

- P **M** K N S H

Chłodzenie wewnętrzne



	DC=3	3<DC≤6	6<DC≤10	10<DC≤18	18<DC≤20
Typ DIN (m7)	+0.012 +0.002	+0.016 +0.004	+0.021 +0.006	+0.025 +0.007	+0.029 +0.008
Inne (h8)	0 -0.014	0 -0.018	0 -0.022	0 -0.027	0 -0.033
		0 -0.008	0 -0.009	0 -0.011	0 -0.013

WIERCENIE

● Typ 1 Typ z chwytem walcowym

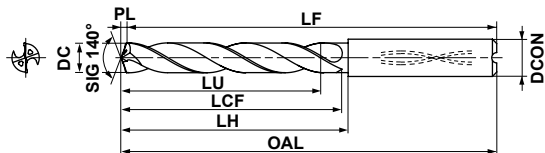

MMS----S/L-DIN-C (L/D 3-5)
MMS----X3/X5DB (L/D 3-5)

● Typ 2 Chwyłt Whistle-Notch

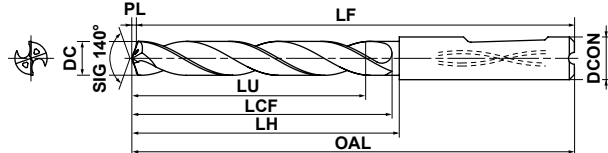

MMS----S/L-DIN (L/D 3-5)

● Typ 3 Typ z chwytem walcowym ze stożkową szyjką

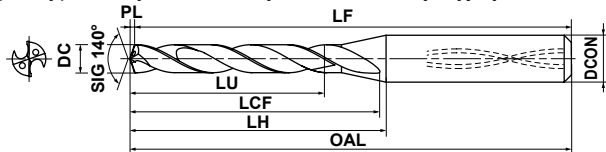

MMS----S/L-DIN-C (L/D 3-5)
MMS----X3/X5DB (L/D 3-5)

● Typ 4 Chwyłt Whistle-Notch ze stożkową szyjką

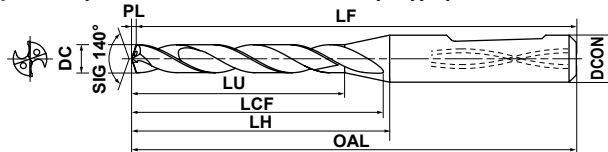

MMS----S/L-DIN (L/D 3-5)

DC (mm)	Głębokość otworu (L/D)	DP7020	Numer zamówieniowy	Wymiary (mm)						Typ	
				LU	LCF	LH	OAL	LF	PL		DCON
3.0	3	□	MMS0300S-DIN	15.0	19.5	24.5	61.5	61	0.5	6	4
	3	●	MMS0300S-DIN-C	15.0	19.5	24.5	61.5	61	0.5	6	3
	5	□	MMS0300L-DIN	23.0	27.5	28.5	65.5	65	0.5	6	4
	5	●	MMS0300L-DIN-C	23.0	27.5	28.5	65.5	65	0.5	6	3
	3	★	MMS0300X3DB	9.5	21.5	23.5	70.5	70	0.5	6	3
	5	★	MMS0300X5DB	15.5	28.5	31.5	78.5	78	0.5	6	3
3.05	3	□	MMS0305S-DIN	15.0	19.6	24.6	61.6	61	0.6	6	4
	3	●	MMS0305S-DIN-C	15.0	19.6	24.6	61.6	61	0.6	6	3
	5	□	MMS0305L-DIN	23.0	27.6	28.6	65.6	65	0.6	6	4
	5	●	MMS0305L-DIN-C	23.0	27.6	28.6	65.6	65	0.6	6	3
3.1	3	□	MMS0310S-DIN	14.9	19.6	24.6	61.6	61	0.6	6	4
	3	●	MMS0310S-DIN-C	14.9	19.6	24.6	61.6	61	0.6	6	3
	5	□	MMS0310L-DIN	22.9	27.6	28.6	65.6	65	0.6	6	4
	5	●	MMS0310L-DIN-C	22.9	27.6	28.6	65.6	65	0.6	6	3
	3	★	MMS0310X3DB	9.9	21.6	23.6	70.6	70	0.6	6	3
	5	★	MMS0310X5DB	16.1	28.6	31.6	78.6	78	0.6	6	3
3.2	3	□	MMS0320S-DIN	14.8	19.6	24.6	61.6	61	0.6	6	4
	3	●	MMS0320S-DIN-C	14.8	19.6	24.6	61.6	61	0.6	6	3
	5	□	MMS0320L-DIN	22.8	27.6	28.6	65.6	65	0.6	6	4
	5	●	MMS0320L-DIN-C	22.8	27.6	28.6	65.6	65	0.6	6	3
	3	★	MMS0320X3DB	10.2	21.6	23.6	70.6	70	0.6	6	3
	5	★	MMS0320X5DB	16.6	28.6	31.6	78.6	78	0.6	6	3
3.3	3	□	MMS0330S-DIN	14.7	19.6	24.6	61.6	61	0.6	6	4
	3	●	MMS0330S-DIN-C	14.7	19.6	24.6	61.6	61	0.6	6	3
	5	□	MMS0330L-DIN	22.7	27.6	28.6	65.6	65	0.6	6	4
	5	●	MMS0330L-DIN-C	22.7	27.6	28.6	65.6	65	0.6	6	3
	3	★	MMS0330X3DB	10.5	21.6	23.6	70.6	70	0.6	6	3
	5	★	MMS0330X5DB	17.1	28.6	31.6	78.6	78	0.6	6	3
3.4	3	□	MMS0340S-DIN	14.5	19.6	24.6	61.6	61	0.6	6	4
	3	●	MMS0340S-DIN-C	14.5	19.6	24.6	61.6	61	0.6	6	3
	5	□	MMS0340L-DIN	22.5	27.6	28.6	65.6	65	0.6	6	4
	5	●	MMS0340L-DIN-C	22.5	27.6	28.6	65.6	65	0.6	6	3

DC (mm)	Głębokość otworu (L/D)	DP7020	Numer zamówieniowy	Wymiary (mm)						Typ	
				LU	LCF	LH	OAL	LF	PL		DCON
3.4	3	★	MMS0340X3DB	10.8	21.6	23.6	70.6	70	0.6	6	3
	5	★	MMS0340X5DB	17.6	28.6	31.6	78.6	78	0.6	6	3
3.5	3	□	MMS0350S-DIN	14.4	19.6	24.6	61.6	61	0.6	6	4
	3	●	MMS0350S-DIN-C	14.4	19.6	24.6	61.6	61	0.6	6	3
	5	□	MMS0350L-DIN	22.4	27.6	28.6	65.6	65	0.6	6	4
	5	●	MMS0350L-DIN-C	22.4	27.6	28.6	65.6	65	0.6	6	3
	3	★	MMS0350X3DB	11.1	21.6	23.6	70.6	70	0.6	6	3
	5	★	MMS0350X5DB	18.1	28.6	31.6	78.6	78	0.6	6	3
3.6	3	□	MMS0360S-DIN	14.3	19.7	24.7	61.7	61	0.7	6	4
	3	●	MMS0360S-DIN-C	14.3	19.7	24.7	61.7	61	0.7	6	3
	5	□	MMS0360L-DIN	22.3	27.7	28.7	65.7	65	0.7	6	4
	5	●	MMS0360L-DIN-C	22.3	27.7	28.7	65.7	65	0.7	6	3
	3	★	MMS0360X3DB	11.5	22.7	23.7	70.7	70	0.7	6	3
	5	★	MMS0360X5DB	18.7	30.7	31.7	78.7	78	0.7	6	3
3.7	3	□	MMS0370S-DIN	14.1	19.7	24.7	61.7	61	0.7	6	4
	3	●	MMS0370S-DIN-C	14.1	19.7	24.7	61.7	61	0.7	6	3
	5	□	MMS0370L-DIN	22.1	27.7	28.7	65.7	65	0.7	6	4
	5	●	MMS0370L-DIN-C	22.1	27.7	28.7	65.7	65	0.7	6	3
	3	★	MMS0370X3DB	11.8	22.7	23.7	70.7	70	0.7	6	3
	5	★	MMS0370X5DB	19.2	30.7	31.7	78.7	78	0.7	6	3
3.8	3	□	MMS0380S-DIN	18.0	23.7	28.7	65.7	65	0.7	6	4
	3	●	MMS0380S-DIN-C	18.0	23.7	28.7	65.7	65	0.7	6	3
	5	□	MMS0380L-DIN	30.0	35.7	36.7	73.7	73	0.7	6	4
	5	●	MMS0380L-DIN-C	30.0	35.7	36.7	73.7	73	0.7	6	3
	3	★	MMS0380X3DB	12.1	22.7	23.7	70.7	70	0.7	6	3
	5	★	MMS0380X5DB	19.7	30.7	31.7	78.7	78	0.7	6	3
3.9	3	□	MMS0390S-DIN	17.9	23.7	28.7	65.7	65	0.7	6	4
	3	●	MMS0390S-DIN-C	17.9	23.7	28.7	65.7	65	0.7	6	3
	5	□	MMS0390L-DIN	29.9	35.7	36.7	73.7	73	0.7	6	4
	5	●	MMS0390L-DIN-C	29.9	35.7	36.7	73.7	73	0.7	6	3
	3	★	MMS0390X3DB	12.4	22.7	23.7	70.7	70	0.7	6	3
	5	★	MMS0390X5DB	20.2	30.7	31.7	78.7	78	0.7	6	3

● : Standard magazynowy. ★ : Na specjalne zamówienie z magazynu w Japonii.

□ : Niestandardowy, produkowany na specjalne zamówienie.

DC (mm)	Głębokość otworu (L/D)	DP7020	Numer zamówieniowy	Wymiary (mm)							Typ
				LU	LCF	LH	OAL	LF	PL	DCON	
4.0	3	□	MMS0400S-DIN	17.7	23.7	28.7	65.7	65	0.7	6	4
	3	●	MMS0400S-DIN-C	17.7	23.7	28.7	65.7	65	0.7	6	3
	5	□	MMS0400L-DIN	29.7	35.7	36.7	73.7	73	0.7	6	4
	5	●	MMS0400L-DIN-C	29.7	35.7	36.7	73.7	73	0.7	6	3
	3	★	MMS0400X3DB	12.7	22.7	23.7	70.7	70	0.7	6	3
	5	★	MMS0400X5DB	20.7	30.7	31.7	78.7	78	0.7	6	3
4.05	3	□	MMS0405S-DIN	17.7	23.7	28.7	65.7	65	0.7	6	4
	3	●	MMS0405S-DIN-C	17.7	23.7	28.7	65.7	65	0.7	6	3
	5	□	MMS0405L-DIN	29.7	35.7	36.7	73.7	73	0.7	6	4
	5	●	MMS0405L-DIN-C	29.7	35.7	36.7	73.7	73	0.7	6	3
4.1	3	□	MMS0410S-DIN	17.6	23.7	28.7	65.7	65	0.7	6	4
	3	●	MMS0410S-DIN-C	17.6	23.7	28.7	65.7	65	0.7	6	3
	5	□	MMS0410L-DIN	29.6	35.7	36.7	73.7	73	0.7	6	4
	5	●	MMS0410L-DIN-C	29.6	35.7	36.7	73.7	73	0.7	6	3
	3	★	MMS0410X3DB	13.0	24.7	26.7	73.7	73	0.7	6	3
5	★	MMS0410X5DB	21.2	33.7	35.7	82.7	82	0.7	6	3	
4.2	3	□	MMS0420S-DIN	17.5	23.8	28.8	65.8	65	0.8	6	4
	3	●	MMS0420S-DIN-C	17.5	23.8	28.8	65.8	65	0.8	6	3
	5	□	MMS0420L-DIN	29.5	35.8	36.8	73.8	73	0.8	6	4
	5	●	MMS0420L-DIN-C	29.5	35.8	36.8	73.8	73	0.8	6	3
	3	★	MMS0420X3DB	13.4	24.8	26.8	73.8	73	0.8	6	3
5	★	MMS0420X5DB	21.8	33.8	35.8	82.8	82	0.8	6	3	
4.3	3	□	MMS0430S-DIN	17.3	23.8	28.8	65.8	65	0.8	6	4
	3	●	MMS0430S-DIN-C	17.3	23.8	28.8	65.8	65	0.8	6	3
	5	□	MMS0430L-DIN	29.3	35.8	36.8	73.8	73	0.8	6	4
	5	●	MMS0430L-DIN-C	29.3	35.8	36.8	73.8	73	0.8	6	3
	3	★	MMS0430X3DB	13.7	24.8	26.8	73.8	73	0.8	6	3
5	★	MMS0430X5DB	22.3	33.8	35.8	82.8	82	0.8	6	3	
4.4	3	□	MMS0440S-DIN	17.2	23.8	28.8	65.8	65	0.8	6	4
	3	●	MMS0440S-DIN-C	17.2	23.8	28.8	65.8	65	0.8	6	3
	5	□	MMS0440L-DIN	29.2	35.8	36.8	73.8	73	0.8	6	4
	5	●	MMS0440L-DIN-C	29.2	35.8	36.8	73.8	73	0.8	6	3
	3	★	MMS0440X3DB	14.0	24.8	26.8	73.8	73	0.8	6	3
5	★	MMS0440X5DB	22.8	33.8	35.8	82.8	82	0.8	6	3	
4.5	3	□	MMS0450S-DIN	17.1	23.8	28.8	65.8	65	0.8	6	4
	3	●	MMS0450S-DIN-C	17.1	23.8	28.8	65.8	65	0.8	6	3
	5	□	MMS0450L-DIN	29.1	35.8	36.8	73.8	73	0.8	6	4
	5	●	MMS0450L-DIN-C	29.1	35.8	36.8	73.8	73	0.8	6	3
	3	★	MMS0450X3DB	14.3	24.8	26.8	73.8	73	0.8	6	3
5	★	MMS0450X5DB	23.3	33.8	35.8	82.8	82	0.8	6	3	
4.6	3	□	MMS0460S-DIN	16.9	23.8	28.8	65.8	65	0.8	6	2
	3	●	MMS0460S-DIN-C	16.9	23.8	28.8	65.8	65	0.8	6	1
	5	□	MMS0460L-DIN	28.9	35.8	36.8	73.8	73	0.8	6	2
	5	●	MMS0460L-DIN-C	28.9	35.8	36.8	73.8	73	0.8	6	1
	3	★	MMS0460X3DB	14.6	25.8	28.8	75.8	75	0.8	6	1
5	★	MMS0460X5DB	23.8	35.8	38.8	85.8	85	0.8	6	1	
4.65	3	□	MMS0465S-DIN	16.9	23.8	28.8	65.8	65	0.8	6	2
	3	●	MMS0465S-DIN-C	16.9	23.8	28.8	65.8	65	0.8	6	1
	5	□	MMS0465L-DIN	28.9	35.8	36.8	73.8	73	0.8	6	2
	5	●	MMS0465L-DIN-C	28.9	35.8	36.8	73.8	73	0.8	6	1

DC (mm)	Głębokość otworu (L/D)	DP7020	Numer zamówieniowy	Wymiary (mm)							Typ
				LU	LCF	LH	OAL	LF	PL	DCON	
4.7	3	□	MMS0470S-DIN	16.8	23.9	28.9	65.9	65	0.9	6	2
	3	●	MMS0470S-DIN-C	16.8	23.9	28.9	65.9	65	0.9	6	1
	5	□	MMS0470L-DIN	28.8	35.9	36.9	73.9	73	0.9	6	2
	5	●	MMS0470L-DIN-C	28.8	35.9	36.9	73.9	73	0.9	6	1
	3	★	MMS0470X3DB	15.0	25.9	28.9	75.9	75	0.9	6	1
5	★	MMS0470X5DB	24.4	35.9	38.9	85.9	85	0.9	6	1	
4.8	3	□	MMS0480S-DIN	20.7	27.9	28.9	65.9	65	0.9	6	2
	3	●	MMS0480S-DIN-C	20.7	27.9	28.9	65.9	65	0.9	6	1
	5	□	MMS0480L-DIN	36.7	43.9	44.9	81.9	81	0.9	6	2
	5	●	MMS0480L-DIN-C	36.7	43.9	44.9	81.9	81	0.9	6	1
	3	★	MMS0480X3DB	15.3	25.9	28.9	75.9	75	0.9	6	1
5	★	MMS0480X5DB	24.9	35.9	38.9	85.9	85	0.9	6	1	
4.9	3	□	MMS0490S-DIN	20.5	27.9	28.9	65.9	65	0.9	6	2
	3	●	MMS0490S-DIN-C	20.5	27.9	28.9	65.9	65	0.9	6	1
	5	□	MMS0490L-DIN	36.5	43.9	44.9	81.9	81	0.9	6	2
	5	●	MMS0490L-DIN-C	36.5	43.9	44.9	81.9	81	0.9	6	1
	3	★	MMS0490X3DB	15.6	25.9	28.9	75.9	75	0.9	6	1
5	★	MMS0490X5DB	25.4	35.9	38.9	85.9	85	0.9	6	1	
5.0	3	□	MMS0500S-DIN	20.4	27.9	28.9	65.9	65	0.9	6	2
	3	●	MMS0500S-DIN-C	20.4	27.9	28.9	65.9	65	0.9	6	1
	5	□	MMS0500L-DIN	36.4	43.9	44.9	81.9	81	0.9	6	2
	5	●	MMS0500L-DIN-C	36.4	43.9	44.9	81.9	81	0.9	6	1
	3	★	MMS0500X3DB	15.9	25.9	28.9	75.9	75	0.9	6	1
5	★	MMS0500X5DB	25.9	35.9	38.9	85.9	85	0.9	6	1	
5.05	3	□	MMS0505S-DIN	20.3	27.9	28.9	65.9	65	0.9	6	2
	3	●	MMS0505S-DIN-C	20.3	27.9	28.9	65.9	65	0.9	6	1
	5	□	MMS0505L-DIN	36.3	43.9	44.9	81.9	81	0.9	6	2
5	●	MMS0505L-DIN-C	36.3	43.9	44.9	81.9	81	0.9	6	1	
5.1	3	□	MMS0510S-DIN	20.3	27.9	28.9	65.9	65	0.9	6	2
	3	●	MMS0510S-DIN-C	20.3	27.9	28.9	65.9	65	0.9	6	1
	5	□	MMS0510L-DIN	36.3	43.9	44.9	81.9	81	0.9	6	2
	5	●	MMS0510L-DIN-C	36.3	43.9	44.9	81.9	81	0.9	6	1
	3	★	MMS0510X3DB	16.2	28.9	30.9	81.9	81	0.9	6	1
5	★	MMS0510X5DB	26.4	39.9	42.9	89.9	89	0.9	6	1	
5.2	3	□	MMS0520S-DIN	20.1	27.9	28.9	65.9	65	0.9	6	2
	3	●	MMS0520S-DIN-C	20.1	27.9	28.9	65.9	65	0.9	6	1
	5	□	MMS0520L-DIN	36.1	43.9	44.9	81.9	81	0.9	6	2
	5	●	MMS0520L-DIN-C	36.1	43.9	44.9	81.9	81	0.9	6	1
	3	★	MMS0520X3DB	16.5	28.9	30.9	81.9	81	0.9	6	1
5	★	MMS0520X5DB	26.9	39.9	42.9	89.9	89	0.9	6	1	
5.3	3	□	MMS0530S-DIN	20.0	28.0	29.0	66.0	65	1.0	6	2
	3	●	MMS0530S-DIN-C	20.0	28.0	29.0	66.0	65	1.0	6	1
	5	□	MMS0530L-DIN	36.0	44.0	45.0	82.0	81	1.0	6	2
	5	●	MMS0530L-DIN-C	36.0	44.0	45.0	82.0	81	1.0	6	1
	3	★	MMS0530X3DB	16.9	29.0	31.0	82.0	81	1.0	6	1
5	★	MMS0530X5DB	27.5	40.0	43.0	90.0	89	1.0	6	1	
5.4	3	□	MMS0540S-DIN	19.9	28.0	29.0	66.0	65	1.0	6	2
	3	●	MMS0540S-DIN-C	19.9	28.0	29.0	66.0	65	1.0	6	1
	5	□	MMS0540L-DIN	35.9	44.0	45.0	82.0	81	1.0	6	2
	5	●	MMS0540L-DIN-C	35.9	44.0	45.0	82.0	81	1.0	6	1
	3	★	MMS0540X3DB	17.2	29.0	31.0	82.0	81	1.0	6	1
5	★	MMS0540X5DB	28.0	40.0	43.0	90.0	89	1.0	6	1	

WIERCENIE (WIERTŁA PEŁNOWĘGLIKOWE)

MMS

WĘGLIKI
SPIEKANE

M

WIERCENIE

DC (mm)	Głębokość otworu (L/D)	DP7020	Numer zamówieniowy	Wymiary (mm)								Typ
				LU	LCF	LH	OAL	LF	PL	DCON		
5.5	3	□	MMS0550S-DIN	19.8	28.0	29.0	66.0	65	1.0	6	2	
	3	●	MMS0550S-DIN-C	19.8	28.0	29.0	66.0	65	1.0	6	1	
	5	□	MMS0550L-DIN	35.8	44.0	45.0	82.0	81	1.0	6	2	
	5	●	MMS0550L-DIN-C	35.8	44.0	45.0	82.0	81	1.0	6	1	
	3	★	MMS0550X3DB	17.5	29.0	31.0	82.0	81	1.0	6	1	
	5	★	MMS0550X5DB	28.5	40.0	43.0	90.0	89	1.0	6	1	
5.55	3	□	MMS0555S-DIN	19.7	28.0	29.0	66.0	65	1.0	6	2	
	3	●	MMS0555S-DIN-C	19.7	28.0	29.0	66.0	65	1.0	6	1	
	5	●	MMS0555L-DIN-C	35.7	44.0	45.0	82.0	81	1.0	6	1	
5.6	3	□	MMS0560S-DIN	19.6	28.0	29.0	66.0	65	1.0	6	2	
	3	●	MMS0560S-DIN-C	19.6	28.0	29.0	66.0	65	1.0	6	1	
	5	□	MMS0560L-DIN	35.6	44.0	45.0	82.0	81	1.0	6	2	
	5	●	MMS0560L-DIN-C	35.6	44.0	45.0	82.0	81	1.0	6	1	
	3	★	MMS0560X3DB	17.8	31.0	31.0	82.0	81	1.0	6	1	
	5	★	MMS0560X5DB	29.0	43.0	43.0	90.0	89	1.0	6	1	
5.7	3	□	MMS0570S-DIN	19.5	28.0	29.0	66.0	65	1.0	6	2	
	3	●	MMS0570S-DIN-C	19.5	28.0	29.0	66.0	65	1.0	6	1	
	5	□	MMS0570L-DIN	35.5	44.0	45.0	82.0	81	1.0	6	2	
	5	●	MMS0570L-DIN-C	35.5	44.0	45.0	82.0	81	1.0	6	1	
	3	★	MMS0570X3DB	18.1	31.0	31.0	82.0	81	1.0	6	1	
	5	★	MMS0570X5DB	29.5	43.0	43.0	90.0	89	1.0	6	1	
5.8	3	□	MMS0580S-DIN	19.4	28.1	29.1	66.1	65	1.1	6	2	
	3	●	MMS0580S-DIN-C	19.4	28.1	29.1	66.1	65	1.1	6	1	
	5	□	MMS0580L-DIN	35.4	44.1	45.1	82.1	81	1.1	6	2	
	5	●	MMS0580L-DIN-C	35.4	44.1	45.1	82.1	81	1.1	6	1	
	3	★	MMS0580X3DB	18.5	31.1	31.1	82.1	81	1.1	6	1	
	5	★	MMS0580X5DB	30.1	43.1	43.1	90.1	89	1.1	6	1	
5.9	3	□	MMS0590S-DIN	19.2	28.1	29.1	66.1	65	1.1	6	2	
	3	□	MMS0590S-DIN-C	19.2	28.1	29.1	66.1	65	1.1	6	1	
	5	□	MMS0590L-DIN	35.2	44.1	45.1	82.1	81	1.1	6	2	
	5	□	MMS0590L-DIN-C	35.2	44.1	45.1	82.1	81	1.1	6	1	
	3	★	MMS0590X3DB	18.8	31.1	31.1	82.1	81	1.1	6	1	
	5	★	MMS0590X5DB	30.6	43.1	43.1	90.1	89	1.1	6	1	
6.0	3	□	MMS0600S-DIN	19.1	28.1	29.1	66.1	65	1.1	6	2	
	3	●	MMS0600S-DIN-C	19.1	28.1	29.1	66.1	65	1.1	6	1	
	5	□	MMS0600L-DIN	35.1	44.1	45.1	82.1	81	1.1	6	2	
	5	●	MMS0600L-DIN-C	35.1	44.1	45.1	82.1	81	1.1	6	1	
	3	★	MMS0600X3DB	19.1	31.1	31.1	82.1	81	1.1	6	1	
	5	★	MMS0600X5DB	31.1	43.1	43.1	90.1	89	1.1	6	1	
6.05	3	□	MMS0605S-DIN	25.0	34.1	42.1	79.1	78	1.1	8	2	
	3	●	MMS0605S-DIN-C	25.0	34.1	42.1	79.1	78	1.1	8	1	
	5	□	MMS0605L-DIN	44.0	53.1	54.1	91.1	90	1.1	8	2	
	5	●	MMS0605L-DIN-C	44.0	53.1	54.1	91.1	90	1.1	8	1	
6.1	3	□	MMS0610S-DIN	25.0	34.1	42.1	79.1	78	1.1	8	2	
	3	●	MMS0610S-DIN-C	25.0	34.1	42.1	79.1	78	1.1	8	1	
	5	□	MMS0610L-DIN	44.0	53.1	54.1	91.1	90	1.1	8	2	
	5	●	MMS0610L-DIN-C	44.0	53.1	54.1	91.1	90	1.1	8	1	
	3	★	MMS0610X3DB	19.4	34.1	36.1	87.1	86	1.1	8	1	
	5	★	MMS0610X5DB	31.6	47.1	49.1	96.1	95	1.1	8	1	

DC (mm)	Głębokość otworu (L/D)	DP7020	Numer zamówieniowy	Wymiary (mm)								Typ
				LU	LCF	LH	OAL	LF	PL	DCON		
6.2	3	□	MMS0620S-DIN	24.8	34.1	42.1	79.1	78	1.1	8	2	
	3	●	MMS0620S-DIN-C	24.8	34.1	42.1	79.1	78	1.1	8	1	
	5	□	MMS0620L-DIN	43.8	53.1	54.1	91.1	90	1.1	8	2	
	5	●	MMS0620L-DIN-C	43.8	53.1	54.1	91.1	90	1.1	8	1	
	3	★	MMS0620X3DB	19.7	34.1	36.1	87.1	86	1.1	8	1	
	5	★	MMS0620X5DB	32.1	47.1	49.1	96.1	95	1.1	8	1	
6.3	3	□	MMS0630S-DIN	24.7	34.1	42.1	79.1	78	1.1	8	2	
	3	□	MMS0630S-DIN-C	24.7	34.1	42.1	79.1	78	1.1	8	1	
	5	□	MMS0630L-DIN	43.7	53.1	54.1	91.1	90	1.1	8	2	
	5	□	MMS0630L-DIN-C	43.7	53.1	54.1	91.1	90	1.1	8	1	
	3	★	MMS0630X3DB	20.0	34.1	36.1	87.1	86	1.1	8	1	
	5	★	MMS0630X5DB	32.6	47.1	49.1	96.1	95	1.1	8	1	
6.4	3	□	MMS0640S-DIN	24.6	34.2	42.2	79.2	78	1.2	8	2	
	3	□	MMS0640S-DIN-C	24.6	34.2	42.2	79.2	78	1.2	8	1	
	5	□	MMS0640L-DIN	43.6	53.2	54.2	91.2	90	1.2	8	2	
	5	□	MMS0640L-DIN-C	43.6	53.2	54.2	91.2	90	1.2	8	1	
	3	★	MMS0640X3DB	20.4	34.2	36.2	87.2	86	1.2	8	1	
	5	★	MMS0640X5DB	33.2	47.2	49.2	96.2	95	1.2	8	1	
6.5	3	□	MMS0650S-DIN	24.4	34.2	42.2	79.2	78	1.2	8	2	
	3	●	MMS0650S-DIN-C	24.4	34.2	42.2	79.2	78	1.2	8	1	
	5	□	MMS0650L-DIN	43.4	53.2	54.2	91.2	90	1.2	8	2	
	5	●	MMS0650L-DIN-C	43.4	53.2	54.2	91.2	90	1.2	8	1	
	3	★	MMS0650X3DB	20.7	34.2	36.2	87.2	86	1.2	8	1	
	5	★	MMS0650X5DB	33.7	47.2	49.2	96.2	95	1.2	8	1	
6.6	3	□	MMS0660S-DIN	24.3	34.2	42.2	79.2	78	1.2	8	2	
	3	●	MMS0660S-DIN-C	24.3	34.2	42.2	79.2	78	1.2	8	1	
	5	□	MMS0660L-DIN	43.3	53.2	54.2	91.2	90	1.2	8	2	
	5	●	MMS0660L-DIN-C	43.3	53.2	54.2	91.2	90	1.2	8	1	
	3	★	MMS0660X3DB	21.0	36.2	38.2	91.2	90	1.2	8	1	
	5	★	MMS0660X5DB	34.2	50.2	52.2	99.2	98	1.2	8	1	
6.7	3	□	MMS0670S-DIN	24.2	34.2	42.2	79.2	78	1.2	8	2	
	3	□	MMS0670S-DIN-C	24.2	34.2	42.2	79.2	78	1.2	8	1	
	5	□	MMS0670L-DIN	43.2	53.2	54.2	91.2	90	1.2	8	2	
	5	□	MMS0670L-DIN-C	43.2	53.2	54.2	91.2	90	1.2	8	1	
	3	★	MMS0670X3DB	21.3	36.2	38.2	91.2	90	1.2	8	1	
	5	★	MMS0670X5DB	34.7	50.2	52.2	99.2	98	1.2	8	1	
6.8	3	□	MMS0680S-DIN	24.0	34.2	42.2	79.2	78	1.2	8	2	
	3	●	MMS0680S-DIN-C	24.0	34.2	42.2	79.2	78	1.2	8	1	
	5	□	MMS0680L-DIN	43.0	53.2	54.2	91.2	90	1.2	8	2	
	5	●	MMS0680L-DIN-C	43.0	53.2	54.2	91.2	90	1.2	8	1	
	3	★	MMS0680X3DB	21.6	36.2	38.2	91.2	90	1.2	8	1	
	5	★	MMS0680X5DB	35.2	50.2	52.2	99.2	98	1.2	8	1	
6.9	3	□	MMS0690S-DIN	23.9	34.3	42.3	79.3	78	1.3	8	2	
	3	●	MMS0690S-DIN-C	23.9	34.3	42.3	79.3	78	1.3	8	1	
	5	□	MMS0690L-DIN	42.9	53.3	54.3	91.3	90	1.3	8	2	
	5	●	MMS0690L-DIN-C	42.9	53.3	54.3	91.3	90	1.3	8	1	
	3	★	MMS0690X3DB	22.0	36.3	38.3	91.3	90	1.3	8	1	
	5	★	MMS0690X5DB	35.8	50.3	52.3	99.3	98	1.3	8	1	

● : Standard magazynowy. ★ : Na specjalne zamówienie z magazynu w Japonii.

□ : Niestandardowy, produkowany na specjalne zamówienie.

DC (mm)	Głębokość otworu (L/D)	DP7020	Numer zamówieniowy	Wymiary (mm)							Typ
				LU	LCF	LH	OAL	LF	PL	DCON	
7.0	3	□	MMS0700S-DIN	23.8	34.3	42.3	79.3	78	1.3	8	2
	3	●	MMS0700S-DIN-C	23.8	34.3	42.3	79.3	78	1.3	8	1
	5	□	MMS0700L-DIN	42.8	53.3	54.3	91.3	90	1.3	8	2
	5	●	MMS0700L-DIN-C	42.8	53.3	54.3	91.3	90	1.3	8	1
	3	★	MMS0700X3DB	22.3	36.3	38.3	91.3	90	1.3	8	1
	5	★	MMS0700X5DB	36.3	50.3	52.3	99.3	98	1.3	8	1
7.1	3	□	MMS0710S-DIN	30.6	41.3	42.3	79.3	78	1.3	8	2
	3	□	MMS0710S-DIN-C	30.6	41.3	42.3	79.3	78	1.3	8	1
	5	□	MMS0710L-DIN	42.6	53.3	54.3	91.3	90	1.3	8	2
	5	□	MMS0710L-DIN-C	42.6	53.3	54.3	91.3	90	1.3	8	1
	3	★	MMS0710X3DB	22.6	39.3	40.3	91.3	90	1.3	8	1
	5	★	MMS0710X5DB	36.8	54.3	57.3	104.3	103	1.3	8	1
7.2	3	□	MMS0720S-DIN	30.5	41.3	42.3	79.3	78	1.3	8	2
	3	□	MMS0720S-DIN-C	30.5	41.3	42.3	79.3	78	1.3	8	1
	5	□	MMS0720L-DIN	42.5	53.3	54.3	91.3	90	1.3	8	2
	5	□	MMS0720L-DIN-C	42.5	53.3	54.3	91.3	90	1.3	8	1
	3	★	MMS0720X3DB	22.9	39.3	40.3	91.3	90	1.3	8	1
	5	★	MMS0720X5DB	37.3	54.3	57.3	104.3	103	1.3	8	1
7.3	3	□	MMS0730S-DIN	30.4	41.3	42.3	79.3	78	1.3	8	2
	3	●	MMS0730S-DIN-C	30.4	41.3	42.3	79.3	78	1.3	8	1
	5	□	MMS0730L-DIN	42.4	53.3	54.3	91.3	90	1.3	8	2
	5	●	MMS0730L-DIN-C	42.4	53.3	54.3	91.3	90	1.3	8	1
	3	★	MMS0730X3DB	23.2	39.3	40.3	91.3	90	1.3	8	1
	5	★	MMS0730X5DB	37.8	54.3	57.3	104.3	103	1.3	8	1
7.4	3	□	MMS0740S-DIN	30.2	41.3	42.3	79.3	78	1.3	8	2
	3	●	MMS0740S-DIN-C	30.2	41.3	42.3	79.3	78	1.3	8	1
	5	□	MMS0740L-DIN	42.2	53.3	54.3	91.3	90	1.3	8	2
	5	●	MMS0740L-DIN-C	42.2	53.3	54.3	91.3	90	1.3	8	1
	3	★	MMS0740X3DB	23.5	39.3	40.3	91.3	90	1.3	8	1
	5	★	MMS0740X5DB	38.3	54.3	57.3	104.3	103	1.3	8	1
7.5	3	□	MMS0750S-DIN	30.1	41.4	42.4	79.4	78	1.4	8	2
	3	●	MMS0750S-DIN-C	30.1	41.4	42.4	79.4	78	1.4	8	1
	5	□	MMS0750L-DIN	42.1	53.4	54.4	91.4	90	1.4	8	2
	5	●	MMS0750L-DIN-C	42.1	53.4	54.4	91.4	90	1.4	8	1
	3	★	MMS0750X3DB	23.9	39.4	40.4	91.4	90	1.4	8	1
	5	★	MMS0750X5DB	38.9	54.4	57.4	104.4	103	1.4	8	1
7.6	3	□	MMS0760S-DIN	30.0	41.4	42.4	79.4	78	1.4	8	2
	3	□	MMS0760S-DIN-C	30.0	41.4	42.4	79.4	78	1.4	8	1
	5	□	MMS0760L-DIN	42.0	53.4	54.4	91.4	90	1.4	8	2
	5	□	MMS0760L-DIN-C	42.0	53.4	54.4	91.4	90	1.4	8	1
	3	★	MMS0760X3DB	24.2	41.4	41.4	91.4	90	1.4	8	1
	5	★	MMS0760X5DB	39.4	57.4	57.4	104.4	103	1.4	8	1
7.7	3	□	MMS0770S-DIN	29.9	41.4	42.4	79.4	78	1.4	8	2
	3	□	MMS0770S-DIN-C	29.9	41.4	42.4	79.4	78	1.4	8	1
	5	□	MMS0770L-DIN	41.9	53.4	54.4	91.4	90	1.4	8	2
	5	□	MMS0770L-DIN-C	41.9	53.4	54.4	91.4	90	1.4	8	1
	3	★	MMS0770X3DB	24.5	41.4	41.4	91.4	90	1.4	8	1
	5	★	MMS0770X5DB	39.9	57.4	57.4	104.4	103	1.4	8	1

DC (mm)	Głębokość otworu (L/D)	DP7020	Numer zamówieniowy	Wymiary (mm)							Typ	
				LU	LCF	LH	OAL	LF	PL	DCON		
7.8	3	□	MMS0780S-DIN	29.7	41.4	42.4	79.4	78	1.4	8	2	
	3	●	MMS0780S-DIN-C	29.7	41.4	42.4	79.4	78	1.4	8	1	
	5	□	MMS0780L-DIN	41.7	53.4	54.4	91.4	90	1.4	8	2	
	5	●	MMS0780L-DIN-C	41.7	53.4	54.4	91.4	90	1.4	8	1	
	3	★	MMS0780X3DB	24.8	41.4	41.4	91.4	90	1.4	8	1	
	5	★	MMS0780X5DB	40.4	57.4	57.4	104.4	103	1.4	8	1	
7.9	3	□	MMS0790S-DIN	29.6	41.4	42.4	79.4	78	1.4	8	2	
	3	□	MMS0790S-DIN-C	29.6	41.4	42.4	79.4	78	1.4	8	1	
	5	□	MMS0790L-DIN	41.6	53.4	54.4	91.4	90	1.4	8	2	
	5	□	MMS0790L-DIN-C	41.6	53.4	54.4	91.4	90	1.4	8	1	
	3	★	MMS0790X3DB	25.1	41.4	41.4	91.4	90	1.4	8	1	
	5	★	MMS0790X5DB	40.9	57.4	57.4	104.4	103	1.4	8	1	
8.0	3	□	MMS0800S-DIN	29.5	41.5	42.5	79.5	78	1.5	8	2	
	3	●	MMS0800S-DIN-C	29.5	41.5	42.5	79.5	78	1.5	8	1	
	5	□	MMS0800L-DIN	41.5	53.5	54.5	91.5	90	1.5	8	2	
	5	●	MMS0800L-DIN-C	41.5	53.5	54.5	91.5	90	1.5	8	1	
	3	★	MMS0800X3DB	25.5	41.5	41.5	91.5	90	1.5	8	1	
	5	★	MMS0800X5DB	41.5	57.5	57.5	104.5	103	1.5	8	1	
8.05	3	□	MMS0805S-DIN	34.4	46.5	47.5	88.5	87	1.5	10	2	
	3	●	MMS0805S-DIN-C	34.4	46.5	47.5	88.5	87	1.5	10	1	
	5	□	MMS0805L-DIN	48.4	60.5	61.5	102.5	101	1.5	10	2	
	5	●	MMS0805L-DIN-C	48.4	60.5	61.5	102.5	101	1.5	10	1	
	8.1	3	□	MMS0810S-DIN	34.3	46.5	47.5	88.5	87	1.5	10	2
		3	□	MMS0810S-DIN-C	34.3	46.5	47.5	88.5	87	1.5	10	1
5		□	MMS0810L-DIN	48.3	60.5	61.5	102.5	101	1.5	10	2	
5		□	MMS0810L-DIN-C	48.3	60.5	61.5	102.5	101	1.5	10	1	
3		★	MMS0810X3DB	25.8	44.5	46.5	97.5	96	1.5	10	1	
5		★	MMS0810X5DB	42.0	61.5	63.5	114.5	113	1.5	10	1	
8.2	3	□	MMS0820S-DIN	34.2	46.5	47.5	88.5	87	1.5	10	2	
	3	□	MMS0820S-DIN-C	34.2	46.5	47.5	88.5	87	1.5	10	1	
	5	□	MMS0820L-DIN	48.2	60.5	61.5	102.5	101	1.5	10	2	
	5	□	MMS0820L-DIN-C	48.2	60.5	61.5	102.5	101	1.5	10	1	
	3	★	MMS0820X3DB	26.1	44.5	46.5	97.5	96	1.5	10	1	
	5	★	MMS0820X5DB	42.5	61.5	63.5	114.5	113	1.5	10	1	
8.3	3	□	MMS0830S-DIN	34.1	46.5	47.5	88.5	87	1.5	10	2	
	3	●	MMS0830S-DIN-C	34.1	46.5	47.5	88.5	87	1.5	10	1	
	5	□	MMS0830L-DIN	48.1	60.5	61.5	102.5	101	1.5	10	2	
	5	●	MMS0830L-DIN-C	48.1	60.5	61.5	102.5	101	1.5	10	1	
	3	★	MMS0830X3DB	26.4	44.5	46.5	97.5	96	1.5	10	1	
	5	★	MMS0830X5DB	43.0	61.5	63.5	114.5	113	1.5	10	1	
8.4	3	□	MMS0840S-DIN	33.9	46.5	47.5	88.5	87	1.5	10	2	
	3	□	MMS0840S-DIN-C	33.9	46.5	47.5	88.5	87	1.5	10	1	
	5	□	MMS0840L-DIN	47.9	60.5	61.5	102.5	101	1.5	10	2	
	5	□	MMS0840L-DIN-C	47.9	60.5	61.5	102.5	101	1.5	10	1	
	3	★	MMS0840X3DB	26.7	44.5	46.5	97.5	96	1.5	10	1	
	5	★	MMS0840X5DB	43.5	61.5	63.5	114.5	113	1.5	10	1	
8.5	3	□	MMS0850S-DIN	33.8	46.5	47.5	88.5	87	1.5	10	2	
	3	●	MMS0850S-DIN-C	33.8	46.5	47.5	88.5	87	1.5	10	1	
	5	□	MMS0850L-DIN	47.8	60.5	61.5	102.5	101	1.5	10	2	
	5	●	MMS0850L-DIN-C	47.8	60.5	61.5	102.5	101	1.5	10	1	
	3	★	MMS0850X3DB	27.0	44.5	46.5	97.5	96	1.5	10	1	
	5	★	MMS0850X5DB	44.0	61.5	63.5	114.5	113	1.5	10	1	

WIERCENIE (WIERTŁA PEŁNOWĘGLIKOWE)

MMS

WĘGLIKI
SPIEKANE

WIERCENIE

M

DC (mm)	Głębokość otworu (L/D)	DP7020	Numer zamówieniowy	Wymiary (mm)							Typ
				LU	LCF	LH	OAL	LF	PL	DCON	
8.6	3	□	MMS0860S-DIN	33.7	46.6	47.6	88.6	87	1.6	10	2
	3	●	MMS0860S-DIN-C	33.7	46.6	47.6	88.6	87	1.6	10	1
	5	□	MMS0860L-DIN	47.7	60.6	61.6	102.6	101	1.6	10	2
	5	●	MMS0860L-DIN-C	47.7	60.6	61.6	102.6	101	1.6	10	1
	3	★	MMS0860X3DB	27.4	46.6	48.6	102.6	101	1.6	10	1
	5	★	MMS0860X5DB	44.6	64.6	66.6	117.6	116	1.6	10	1
8.7	3	□	MMS0870S-DIN	33.5	46.6	47.6	88.6	87	1.6	10	2
	3	●	MMS0870S-DIN-C	33.5	46.6	47.6	88.6	87	1.6	10	1
	5	□	MMS0870L-DIN	47.5	60.6	61.6	102.6	101	1.6	10	2
	5	●	MMS0870L-DIN-C	47.5	60.6	61.6	102.6	101	1.6	10	1
	3	★	MMS0870X3DB	27.7	46.6	48.6	102.6	101	1.6	10	1
	5	★	MMS0870X5DB	45.1	64.6	66.6	117.6	116	1.6	10	1
8.8	3	□	MMS0880S-DIN	33.4	46.6	47.6	88.6	87	1.6	10	2
	3	●	MMS0880S-DIN-C	33.4	46.6	47.6	88.6	87	1.6	10	1
	5	□	MMS0880L-DIN	47.4	60.6	61.6	102.6	101	1.6	10	2
	5	●	MMS0880L-DIN-C	47.4	60.6	61.6	102.6	101	1.6	10	1
	3	★	MMS0880X3DB	28.0	46.6	48.6	102.6	101	1.6	10	1
	5	★	MMS0880X5DB	45.6	64.6	66.6	117.6	116	1.6	10	1
8.9	3	□	MMS0890S-DIN	33.3	46.6	47.6	88.6	87	1.6	10	2
	3	●	MMS0890S-DIN-C	33.3	46.6	47.6	88.6	87	1.6	10	1
	5	□	MMS0890L-DIN	47.3	60.6	61.6	102.6	101	1.6	10	2
	5	●	MMS0890L-DIN-C	47.3	60.6	61.6	102.6	101	1.6	10	1
	3	★	MMS0890X3DB	28.3	46.6	48.6	102.6	101	1.6	10	1
	5	★	MMS0890X5DB	46.1	64.6	66.6	117.6	116	1.6	10	1
9.0	3	□	MMS0900S-DIN	33.1	46.6	47.6	88.6	87	1.6	10	2
	3	●	MMS0900S-DIN-C	33.1	46.6	47.6	88.6	87	1.6	10	1
	5	□	MMS0900L-DIN	47.1	60.6	61.6	102.6	101	1.6	10	2
	5	●	MMS0900L-DIN-C	47.1	60.6	61.6	102.6	101	1.6	10	1
	3	★	MMS0900X3DB	28.6	46.6	48.6	102.6	101	1.6	10	1
	5	★	MMS0900X5DB	46.6	64.6	66.6	117.6	116	1.6	10	1
9.1	3	□	MMS0910S-DIN	33.0	46.7	47.7	88.7	87	1.7	10	2
	3	●	MMS0910S-DIN-C	33.0	46.7	47.7	88.7	87	1.7	10	1
	5	□	MMS0910L-DIN	47.0	60.7	61.7	102.7	101	1.7	10	2
	5	●	MMS0910L-DIN-C	47.0	60.7	61.7	102.7	101	1.7	10	1
	3	★	MMS0910X3DB	29.0	49.7	51.7	102.7	101	1.7	10	1
	5	★	MMS0910X5DB	47.2	68.7	71.7	122.7	121	1.7	10	1
9.2	3	□	MMS0920S-DIN	32.9	46.7	47.7	88.7	87	1.7	10	2
	3	●	MMS0920S-DIN-C	32.9	46.7	47.7	88.7	87	1.7	10	1
	5	□	MMS0920L-DIN	46.9	60.7	61.7	102.7	101	1.7	10	2
	5	●	MMS0920L-DIN-C	46.9	60.7	61.7	102.7	101	1.7	10	1
	3	★	MMS0920X3DB	29.3	49.7	51.7	102.7	101	1.7	10	1
	5	★	MMS0920X5DB	47.7	68.7	71.7	122.7	121	1.7	10	1
9.3	3	□	MMS0930S-DIN	32.7	46.7	47.7	88.7	87	1.7	10	2
	3	●	MMS0930S-DIN-C	32.7	46.7	47.7	88.7	87	1.7	10	1
	5	□	MMS0930L-DIN	46.7	60.7	61.7	102.7	101	1.7	10	2
	5	●	MMS0930L-DIN-C	46.7	60.7	61.7	102.7	101	1.7	10	1
	3	★	MMS0930X3DB	29.6	49.7	51.7	102.7	101	1.7	10	1
	5	★	MMS0930X5DB	48.2	68.7	71.7	122.7	121	1.7	10	1

DC (mm)	Głębokość otworu (L/D)	DP7020	Numer zamówieniowy	Wymiary (mm)							Typ
				LU	LCF	LH	OAL	LF	PL	DCON	
9.4	3	□	MMS0940S-DIN	32.6	46.7	47.7	88.7	87	1.7	10	2
	3	●	MMS0940S-DIN-C	32.6	46.7	47.7	88.7	87	1.7	10	1
	5	□	MMS0940L-DIN	46.6	60.7	61.7	102.7	101	1.7	10	2
	5	●	MMS0940L-DIN-C	46.6	60.7	61.7	102.7	101	1.7	10	1
	3	★	MMS0940X3DB	29.9	49.7	51.7	102.7	101	1.7	10	1
	5	★	MMS0940X5DB	48.7	68.7	71.7	122.7	121	1.7	10	1
9.5	3	□	MMS0950S-DIN	32.5	46.7	47.7	88.7	87	1.7	10	2
	3	●	MMS0950S-DIN-C	32.5	46.7	47.7	88.7	87	1.7	10	1
	5	□	MMS0950L-DIN	46.5	60.7	61.7	102.7	101	1.7	10	2
	5	●	MMS0950L-DIN-C	46.5	60.7	61.7	102.7	101	1.7	10	1
	3	★	MMS0950X3DB	30.2	49.7	51.7	102.7	101	1.7	10	1
	5	★	MMS0950X5DB	49.2	68.7	71.7	122.7	121	1.7	10	1
9.6	3	□	MMS0960S-DIN	32.3	46.7	47.7	88.7	87	1.7	10	2
	3	●	MMS0960S-DIN-C	32.3	46.7	47.7	88.7	87	1.7	10	1
	5	□	MMS0960L-DIN	46.3	60.7	61.7	102.7	101	1.7	10	2
	5	●	MMS0960L-DIN-C	46.3	60.7	61.7	102.7	101	1.7	10	1
	3	★	MMS0960X3DB	30.5	51.7	51.7	102.7	101	1.7	10	1
	5	★	MMS0960X5DB	49.7	71.7	71.7	122.7	121	1.7	10	1
9.7	3	□	MMS0970S-DIN	32.2	46.8	47.8	88.8	87	1.8	10	2
	3	●	MMS0970S-DIN-C	32.2	46.8	47.8	88.8	87	1.8	10	1
	5	□	MMS0970L-DIN	46.2	60.8	61.8	102.8	101	1.8	10	2
	5	●	MMS0970L-DIN-C	46.2	60.8	61.8	102.8	101	1.8	10	1
	3	★	MMS0970X3DB	30.9	51.8	51.8	102.8	101	1.8	10	1
	5	★	MMS0970X5DB	50.3	71.8	71.8	122.8	121	1.8	10	1
9.8	3	□	MMS0980S-DIN	32.1	46.8	47.8	88.8	87	1.8	10	2
	3	●	MMS0980S-DIN-C	32.1	46.8	47.8	88.8	87	1.8	10	1
	5	□	MMS0980L-DIN	46.1	60.8	61.8	102.8	101	1.8	10	2
	5	●	MMS0980L-DIN-C	46.1	60.8	61.8	102.8	101	1.8	10	1
	3	★	MMS0980X3DB	31.2	51.8	51.8	102.8	101	1.8	10	1
	5	★	MMS0980X5DB	50.8	71.8	71.8	122.8	121	1.8	10	1
9.9	3	□	MMS0990S-DIN	32.0	46.8	47.8	88.8	87	1.8	10	2
	3	●	MMS0990S-DIN-C	32.0	46.8	47.8	88.8	87	1.8	10	1
	5	□	MMS0990L-DIN	46.0	60.8	61.8	102.8	101	1.8	10	2
	5	●	MMS0990L-DIN-C	46.0	60.8	61.8	102.8	101	1.8	10	1
	3	★	MMS0990X3DB	31.5	51.8	51.8	102.8	101	1.8	10	1
	5	★	MMS0990X5DB	51.3	71.8	71.8	122.8	121	1.8	10	1
10.0	3	□	MMS1000S-DIN	31.8	46.8	47.8	88.8	87	1.8	10	2
	3	●	MMS1000S-DIN-C	31.8	46.8	47.8	88.8	87	1.8	10	1
	5	□	MMS1000L-DIN	45.8	60.8	61.8	102.8	101	1.8	10	2
	5	●	MMS1000L-DIN-C	45.8	60.8	61.8	102.8	101	1.8	10	1
	3	★	MMS1000X3DB	31.8	51.8	51.8	102.8	101	1.8	10	1
	5	★	MMS1000X5DB	51.8	71.8	71.8	122.8	121	1.8	10	1
10.05	3	□	MMS1005S-DIN	39.8	54.8	55.8	101.8	100	1.8	12	2
	3	●	MMS1005S-DIN-C	39.8	54.8	55.8	101.8	100	1.8	12	1
	5	□	MMS1005L-DIN	55.8	70.8	71.8	117.8	116	1.8	12	2
	5	●	MMS1005L-DIN-C	55.8	70.8	71.8	117.8	116	1.8	12	1

● : Standard magazynowy. ★ : Na specjalne zamówienie z magazynu w Japonii.

□ : Niestandardowy, produkowany na specjalne zamówienie.

DC (mm)	Głębokość otworu (L/D)	DP7020	Numer zamówieniowy	Wymiary (mm)								Typ
				LU	LCF	LH	OAL	LF	PL	DCON		
10.1	3	□	MMS1010S-DIN	39.7	54.8	55.8	101.8	100	1.8	12	2	
	3	□	MMS1010S-DIN-C	39.7	54.8	55.8	101.8	100	1.8	12	1	
	5	□	MMS1010L-DIN	55.7	70.8	71.8	117.8	116	1.8	12	2	
	5	□	MMS1010L-DIN-C	55.7	70.8	71.8	117.8	116	1.8	12	1	
	3	★	MMS1010X3DB	32.1	54.8	56.8	112.8	111	1.8	12	1	
	5	★	MMS1010X5DB	52.3	75.8	79.8	135.8	134	1.8	12	1	
10.2	3	□	MMS1020S-DIN	39.6	54.9	55.9	101.9	100	1.9	12	2	
	3	●	MMS1020S-DIN-C	39.6	54.9	55.9	101.9	100	1.9	12	1	
	5	□	MMS1020L-DIN	55.6	70.9	71.9	117.9	116	1.9	12	2	
	5	●	MMS1020L-DIN-C	55.6	70.9	71.9	117.9	116	1.9	12	1	
	3	★	MMS1020X3DB	32.5	54.9	56.9	112.9	111	1.9	12	1	
	5	★	MMS1020X5DB	52.9	75.9	79.9	135.9	134	1.9	12	1	
10.3	3	□	MMS1030S-DIN	39.4	54.9	55.9	101.9	100	1.9	12	2	
	3	●	MMS1030S-DIN-C	39.4	54.9	55.9	101.9	100	1.9	12	1	
	5	□	MMS1030L-DIN	55.4	70.9	71.9	117.9	116	1.9	12	2	
	5	●	MMS1030L-DIN-C	55.4	70.9	71.9	117.9	116	1.9	12	1	
	3	★	MMS1030X3DB	32.8	54.9	56.9	112.9	111	1.9	12	1	
	5	★	MMS1030X5DB	53.4	75.9	79.9	135.9	134	1.9	12	1	
10.4	3	□	MMS1040S-DIN	39.3	54.9	55.9	101.9	100	1.9	12	2	
	3	●	MMS1040S-DIN-C	39.3	54.9	55.9	101.9	100	1.9	12	1	
	5	□	MMS1040L-DIN	55.3	70.9	71.9	117.9	116	1.9	12	2	
	5	●	MMS1040L-DIN-C	55.3	70.9	71.9	117.9	116	1.9	12	1	
	3	★	MMS1040X3DB	33.1	54.9	56.9	112.9	111	1.9	12	1	
	5	★	MMS1040X5DB	53.9	75.9	79.9	135.9	134	1.9	12	1	
10.5	3	□	MMS1050S-DIN	39.2	54.9	55.9	101.9	100	1.9	12	2	
	3	●	MMS1050S-DIN-C	39.2	54.9	55.9	101.9	100	1.9	12	1	
	5	□	MMS1050L-DIN	55.2	70.9	71.9	117.9	116	1.9	12	2	
	5	●	MMS1050L-DIN-C	55.2	70.9	71.9	117.9	116	1.9	12	1	
	3	★	MMS1050X3DB	33.4	54.9	56.9	112.9	111	1.9	12	1	
	5	★	MMS1050X5DB	54.4	75.9	79.9	135.9	134	1.9	12	1	
10.6	3	□	MMS1060S-DIN	39.0	54.9	55.9	101.9	100	1.9	12	2	
	3	□	MMS1060S-DIN-C	39.0	54.9	55.9	101.9	100	1.9	12	1	
	5	□	MMS1060L-DIN	55.0	70.9	71.9	117.9	116	1.9	12	2	
	5	□	MMS1060L-DIN-C	55.0	70.9	71.9	117.9	116	1.9	12	1	
	3	★	MMS1060X3DB	33.7	56.9	57.9	117.9	116	1.9	12	1	
	5	★	MMS1060X5DB	54.9	78.9	79.9	135.9	134	1.9	12	1	
10.7	3	□	MMS1070S-DIN	38.9	54.9	55.9	101.9	100	1.9	12	2	
	3	●	MMS1070S-DIN-C	38.9	54.9	55.9	101.9	100	1.9	12	1	
	5	□	MMS1070L-DIN	54.9	70.9	71.9	117.9	116	1.9	12	2	
	5	●	MMS1070L-DIN-C	54.9	70.9	71.9	117.9	116	1.9	12	1	
	3	★	MMS1070X3DB	34.0	56.9	57.9	117.9	116	1.9	12	1	
	5	★	MMS1070X5DB	55.4	78.9	79.9	135.9	134	1.9	12	1	
10.8	3	□	MMS1080S-DIN	38.8	55.0	56.0	102.0	100	2.0	12	2	
	3	●	MMS1080S-DIN-C	38.8	55.0	56.0	102.0	100	2.0	12	1	
	5	□	MMS1080L-DIN	54.8	71.0	72.0	118.0	116	2.0	12	2	
	5	●	MMS1080L-DIN-C	54.8	71.0	72.0	118.0	116	2.0	12	1	
	3	★	MMS1080X3DB	34.4	57.0	58.0	118.0	116	2.0	12	1	
	5	★	MMS1080X5DB	56.0	79.0	80.0	136.0	134	2.0	12	1	

DC (mm)	Głębokość otworu (L/D)	DP7020	Numer zamówieniowy	Wymiary (mm)								Typ
				LU	LCF	LH	OAL	LF	PL	DCON		
10.9	3	□	MMS1090S-DIN	38.6	55.0	56.0	102.0	100	2.0	12	2	
	3	□	MMS1090S-DIN-C	38.6	55.0	56.0	102.0	100	2.0	12	1	
	5	□	MMS1090L-DIN	54.6	71.0	72.0	118.0	116	2.0	12	2	
	5	□	MMS1090L-DIN-C	54.6	71.0	72.0	118.0	116	2.0	12	1	
	3	★	MMS1090X3DB	34.7	57.0	58.0	118.0	116	2.0	12	1	
	5	★	MMS1090X5DB	56.5	79.0	80.0	136.0	134	2.0	12	1	
11.0	3	□	MMS1100S-DIN	38.5	55.0	56.0	102.0	100	2.0	12	2	
	3	●	MMS1100S-DIN-C	38.5	55.0	56.0	102.0	100	2.0	12	1	
	5	□	MMS1100L-DIN	54.5	71.0	72.0	118.0	116	2.0	12	2	
	5	●	MMS1100L-DIN-C	54.5	71.0	72.0	118.0	116	2.0	12	1	
	3	★	MMS1100X3DB	35.0	57.0	58.0	118.0	116	2.0	12	1	
	5	★	MMS1100X5DB	57.0	79.0	80.0	136.0	134	2.0	12	1	
11.1	3	□	MMS1110S-DIN	38.4	55.0	56.0	102.0	100	2.0	12	2	
	3	□	MMS1110S-DIN-C	38.4	55.0	56.0	102.0	100	2.0	12	1	
	5	□	MMS1110L-DIN	54.4	71.0	72.0	118.0	116	2.0	12	2	
	5	□	MMS1110L-DIN-C	54.4	71.0	72.0	118.0	116	2.0	12	1	
	3	★	MMS1110X3DB	35.3	60.0	62.0	118.0	116	2.0	12	1	
	5	★	MMS1110X5DB	57.5	83.0	86.0	142.0	140	2.0	12	1	
11.2	3	□	MMS1120S-DIN	38.2	55.0	56.0	102.0	100	2.0	12	2	
	3	●	MMS1120S-DIN-C	38.2	55.0	56.0	102.0	100	2.0	12	1	
	5	□	MMS1120L-DIN	54.2	71.0	72.0	118.0	116	2.0	12	2	
	5	●	MMS1120L-DIN-C	54.2	71.0	72.0	118.0	116	2.0	12	1	
	3	★	MMS1120X3DB	35.6	60.0	62.0	118.0	116	2.0	12	1	
	5	★	MMS1120X5DB	58.0	83.0	86.0	142.0	140	2.0	12	1	
11.3	3	□	MMS1130S-DIN	38.1	55.1	56.1	102.1	100	2.1	12	2	
	3	□	MMS1130S-DIN-C	38.1	55.1	56.1	102.1	100	2.1	12	1	
	5	□	MMS1130L-DIN	54.1	71.1	72.1	118.1	116	2.1	12	2	
	5	□	MMS1130L-DIN-C	54.1	71.1	72.1	118.1	116	2.1	12	1	
	3	★	MMS1130X3DB	36.0	60.1	62.1	118.1	116	2.1	12	1	
	5	★	MMS1130X5DB	58.6	83.1	86.1	142.1	140	2.1	12	1	
11.4	3	□	MMS1140S-DIN	38.0	55.1	56.1	102.1	100	2.1	12	2	
	3	●	MMS1140S-DIN-C	38.0	55.1	56.1	102.1	100	2.1	12	1	
	5	□	MMS1140L-DIN	54.0	71.1	72.1	118.1	116	2.1	12	2	
	5	●	MMS1140L-DIN-C	54.0	71.1	72.1	118.1	116	2.1	12	1	
	3	★	MMS1140X3DB	36.3	60.1	62.1	118.1	116	2.1	12	1	
	5	★	MMS1140X5DB	59.1	83.1	86.1	142.1	140	2.1	12	1	
11.5	3	□	MMS1150S-DIN	37.8	55.1	56.1	102.1	100	2.1	12	2	
	3	●	MMS1150S-DIN-C	37.8	55.1	56.1	102.1	100	2.1	12	1	
	5	□	MMS1150L-DIN	53.8	71.1	72.1	118.1	116	2.1	12	2	
	5	●	MMS1150L-DIN-C	53.8	71.1	72.1	118.1	116	2.1	12	1	
	3	★	MMS1150X3DB	36.6	60.1	62.1	118.1	116	2.1	12	1	
	5	★	MMS1150X5DB	59.6	83.1	86.1	142.1	140	2.1	12	1	
11.6	3	□	MMS1160S-DIN	37.7	55.1	56.1	102.1	100	2.1	12	2	
	3	□	MMS1160S-DIN-C	37.7	55.1	56.1	102.1	100	2.1	12	1	
	5	□	MMS1160L-DIN	53.7	71.1	72.1	118.1	116	2.1	12	2	
	5	□	MMS1160L-DIN-C	53.7	71.1	72.1	118.1	116	2.1	12	1	
	3	★	MMS1160X3DB	36.9	62.1	62.1	118.1	116	2.1	12	1	
	5	★	MMS1160X5DB	60.1	86.1	86.1	142.1	140	2.1	12	1	

WIERCENIE (WIERTŁA PEŁNOWĘGLIKOWE)

MMS

WĘGLIKI
SPIEKANE

M

WIERCENIE

DC (mm)	Głębokość otworu (L/D)	DP7020	Numer zamówieniowy	Wymiary (mm)							Typ
				LU	LCF	LH	OAL	LF	PL	DCON	
11.7	3	□	MMS1170S-DIN	37.6	55.1	56.1	102.1	100	2.1	12	2
	3	●	MMS1170S-DIN-C	37.6	55.1	56.1	102.1	100	2.1	12	1
	5	□	MMS1170L-DIN	53.6	71.1	72.1	118.1	116	2.1	12	2
	5	●	MMS1170L-DIN-C	53.6	71.1	72.1	118.1	116	2.1	12	1
	3	★	MMS1170X3DB	37.2	62.1	62.1	118.1	116	2.1	12	1
	5	★	MMS1170X5DB	60.6	86.1	86.1	142.1	140	2.1	12	1
11.8	3	□	MMS1180S-DIN	37.4	55.1	56.1	102.1	100	2.1	12	2
	3	●	MMS1180S-DIN-C	37.4	55.1	56.1	102.1	100	2.1	12	1
	5	□	MMS1180L-DIN	53.4	71.1	72.1	118.1	116	2.1	12	2
	5	●	MMS1180L-DIN-C	53.4	71.1	72.1	118.1	116	2.1	12	1
	3	★	MMS1180X3DB	37.5	62.1	62.1	118.1	116	2.1	12	1
	5	★	MMS1180X5DB	61.1	86.1	86.1	142.1	140	2.1	12	1
11.9	3	□	MMS1190S-DIN	37.3	55.2	56.2	102.2	100	2.2	12	2
	3	●	MMS1190S-DIN-C	37.3	55.2	56.2	102.2	100	2.2	12	1
	5	□	MMS1190L-DIN	53.3	71.2	72.2	118.2	116	2.2	12	2
	5	●	MMS1190L-DIN-C	53.3	71.2	72.2	118.2	116	2.2	12	1
	3	★	MMS1190X3DB	37.9	62.2	62.2	118.2	116	2.2	12	1
	5	★	MMS1190X5DB	61.7	86.2	86.2	142.2	140	2.2	12	1
12.0	3	□	MMS1200S-DIN	37.2	55.2	56.2	102.2	100	2.2	12	2
	3	●	MMS1200S-DIN-C	37.2	55.2	56.2	102.2	100	2.2	12	1
	5	□	MMS1200L-DIN	53.2	71.2	72.2	118.2	116	2.2	12	2
	5	●	MMS1200L-DIN-C	53.2	71.2	72.2	118.2	116	2.2	12	1
	3	★	MMS1200X3DB	38.2	62.2	62.2	118.2	116	2.2	12	1
	5	★	MMS1200X5DB	62.2	86.2	86.2	142.2	140	2.2	12	1
12.05	3	□	MMS1205S-DIN	42.1	60.2	61.2	107.2	105	2.2	14	2
	3	●	MMS1205S-DIN-C	42.1	60.2	61.2	107.2	105	2.2	14	1
	5	□	MMS1205L-DIN	59.1	77.2	78.2	124.2	122	2.2	14	2
	5	●	MMS1205L-DIN-C	59.1	77.2	78.2	124.2	122	2.2	14	1
12.1	3	□	MMS1210S-DIN	42.1	60.2	61.2	107.2	105	2.2	14	2
	3	●	MMS1210S-DIN-C	42.1	60.2	61.2	107.2	105	2.2	14	1
	5	□	MMS1210L-DIN	59.1	77.2	78.2	124.2	122	2.2	14	2
	5	●	MMS1210L-DIN-C	59.1	77.2	78.2	124.2	122	2.2	14	1
	3	★	MMS1210X3DB	38.5	65.2	68.2	124.2	122	2.2	14	1
	5	★	MMS1210X5DB	62.7	90.2	94.2	150.2	148	2.2	14	1
12.2	3	□	MMS1220S-DIN	41.9	60.2	61.2	107.2	105	2.2	14	2
	3	●	MMS1220S-DIN-C	41.9	60.2	61.2	107.2	105	2.2	14	1
	5	□	MMS1220L-DIN	58.9	77.2	78.2	124.2	122	2.2	14	2
	5	●	MMS1220L-DIN-C	58.9	77.2	78.2	124.2	122	2.2	14	1
	3	★	MMS1220X3DB	38.8	65.2	68.2	124.2	122	2.2	14	1
	5	★	MMS1220X5DB	63.2	90.2	94.2	150.2	148	2.2	14	1
12.3	3	□	MMS1230S-DIN	41.8	60.2	61.2	107.2	105	2.2	14	2
	3	●	MMS1230S-DIN-C	41.8	60.2	61.2	107.2	105	2.2	14	1
	5	□	MMS1230L-DIN	58.8	77.2	78.2	124.2	122	2.2	14	2
	5	●	MMS1230L-DIN-C	58.8	77.2	78.2	124.2	122	2.2	14	1
	3	★	MMS1230X3DB	39.1	65.2	68.2	124.2	122	2.2	14	1
	5	★	MMS1230X5DB	63.7	90.2	94.2	150.2	148	2.2	14	1

DC (mm)	Głębokość otworu (L/D)	DP7020	Numer zamówieniowy	Wymiary (mm)							Typ
				LU	LCF	LH	OAL	LF	PL	DCON	
12.4	3	□	MMS1240S-DIN	41.7	60.3	61.3	107.3	105	2.3	14	2
	3	●	MMS1240S-DIN-C	41.7	60.3	61.3	107.3	105	2.3	14	1
	5	□	MMS1240L-DIN	58.7	77.3	78.3	124.3	122	2.3	14	2
	5	●	MMS1240L-DIN-C	58.7	77.3	78.3	124.3	122	2.3	14	1
	3	★	MMS1240X3DB	39.5	65.3	68.3	124.3	122	2.3	14	1
	5	★	MMS1240X5DB	64.3	90.3	94.3	150.3	148	2.3	14	1
12.5	3	□	MMS1250S-DIN	41.5	60.3	61.3	107.3	105	2.3	14	2
	3	●	MMS1250S-DIN-C	41.5	60.3	61.3	107.3	105	2.3	14	1
	5	□	MMS1250L-DIN	58.5	77.3	78.3	124.3	122	2.3	14	2
	5	●	MMS1250L-DIN-C	58.5	77.3	78.3	124.3	122	2.3	14	1
	3	★	MMS1250X3DB	39.8	65.3	68.3	124.3	122	2.3	14	1
	5	★	MMS1250X5DB	64.8	90.3	94.3	150.3	148	2.3	14	1
12.6	3	□	MMS1260S-DIN	41.4	60.3	61.3	107.3	105	2.3	14	2
	3	●	MMS1260S-DIN-C	41.4	60.3	61.3	107.3	105	2.3	14	1
	5	□	MMS1260L-DIN	58.4	77.3	78.3	124.3	122	2.3	14	2
	5	●	MMS1260L-DIN-C	58.4	77.3	78.3	124.3	122	2.3	14	1
	3	★	MMS1260X3DB	40.1	67.3	68.3	124.3	122	2.3	14	1
	5	★	MMS1260X5DB	65.3	93.3	94.3	150.3	148	2.3	14	1
12.7	3	□	MMS1270S-DIN	41.3	60.3	61.3	107.3	105	2.3	14	2
	3	●	MMS1270S-DIN-C	41.3	60.3	61.3	107.3	105	2.3	14	1
	5	□	MMS1270L-DIN	58.3	77.3	78.3	124.3	122	2.3	14	2
	5	●	MMS1270L-DIN-C	58.3	77.3	78.3	124.3	122	2.3	14	1
	3	★	MMS1270X3DB	40.4	67.3	68.3	124.3	122	2.3	14	1
	5	★	MMS1270X5DB	65.8	93.3	94.3	150.3	148	2.3	14	1
12.8	3	□	MMS1280S-DIN	41.1	60.3	61.3	107.3	105	2.3	14	2
	3	●	MMS1280S-DIN-C	41.1	60.3	61.3	107.3	105	2.3	14	1
	5	□	MMS1280L-DIN	58.1	77.3	78.3	124.3	122	2.3	14	2
	5	●	MMS1280L-DIN-C	58.1	77.3	78.3	124.3	122	2.3	14	1
	3	★	MMS1280X3DB	40.7	67.3	68.3	124.3	122	2.3	14	1
	5	★	MMS1280X5DB	66.3	93.3	94.3	150.3	148	2.3	14	1
12.9	3	□	MMS1290S-DIN	41.0	60.3	61.3	107.3	105	2.3	14	2
	3	●	MMS1290S-DIN-C	41.0	60.3	61.3	107.3	105	2.3	14	1
	5	□	MMS1290L-DIN	58.0	77.3	78.3	124.3	122	2.3	14	2
	5	●	MMS1290L-DIN-C	58.0	77.3	78.3	124.3	122	2.3	14	1
	3	★	MMS1290X3DB	41.0	67.3	68.3	124.3	122	2.3	14	1
	5	★	MMS1290X5DB	66.8	93.3	94.3	150.3	148	2.3	14	1
13.0	3	□	MMS1300S-DIN	40.9	60.4	61.4	107.4	105	2.4	14	2
	3	●	MMS1300S-DIN-C	40.9	60.4	61.4	107.4	105	2.4	14	1
	5	□	MMS1300L-DIN	57.9	77.4	78.4	124.4	122	2.4	14	2
	5	●	MMS1300L-DIN-C	57.9	77.4	78.4	124.4	122	2.4	14	1
	3	★	MMS1300X3DB	41.4	67.4	68.4	124.4	122	2.4	14	1
	5	★	MMS1300X5DB	67.4	93.4	94.4	150.4	148	2.4	14	1
13.1	3	□	MMS1310S-DIN	40.7	60.4	61.4	107.4	105	2.4	14	2
	3	●	MMS1310S-DIN-C	40.7	60.4	61.4	107.4	105	2.4	14	1
	5	□	MMS1310L-DIN	57.7	77.4	78.4	124.4	122	2.4	14	2
	5	●	MMS1310L-DIN-C	57.7	77.4	78.4	124.4	122	2.4	14	1
	3	★	MMS1310X3DB	41.7	70.4	72.4	128.4	126	2.4	14	1
	5	★	MMS1310X5DB	67.9	97.4	100.4	156.4	154	2.4	14	1

● : Standard magazynowy. ★ : Na specjalne zamówienie z magazynu w Japonii.

□ : Niestandardowy, produkowany na specjalne zamówienie.

DC	Głębokość otworu (L/D)	DP7020	Numer zamówieniowy	Wymiary (mm)							Typ
				LU	LCF	LH	OAL	LF	PL	DCON	
13.2	3	□	MMS1320S-DIN	40.6	60.4	61.4	107.4	105	2.4	14	2
	3	□	MMS1320S-DIN-C	40.6	60.4	61.4	107.4	105	2.4	14	1
	5	□	MMS1320L-DIN	57.6	77.4	78.4	124.4	122	2.4	14	2
	5	□	MMS1320L-DIN-C	57.6	77.4	78.4	124.4	122	2.4	14	1
	3	★	MMS1320X3DB	42.0	70.4	72.4	128.4	126	2.4	14	1
	5	★	MMS1320X5DB	68.4	97.4	100.4	156.4	154	2.4	14	1
13.3	3	□	MMS1330S-DIN	40.5	60.4	61.4	107.4	105	2.4	14	2
	3	□	MMS1330S-DIN-C	40.5	60.4	61.4	107.4	105	2.4	14	1
	5	□	MMS1330L-DIN	57.5	77.4	78.4	124.4	122	2.4	14	2
	5	□	MMS1330L-DIN-C	57.5	77.4	78.4	124.4	122	2.4	14	1
	3	★	MMS1330X3DB	42.3	70.4	72.4	128.4	126	2.4	14	1
	5	★	MMS1330X5DB	68.9	97.4	100.4	156.4	154	2.4	14	1
13.4	3	□	MMS1340S-DIN	40.3	60.4	61.4	107.4	105	2.4	14	2
	3	□	MMS1340S-DIN-C	40.3	60.4	61.4	107.4	105	2.4	14	1
	5	□	MMS1340L-DIN	57.3	77.4	78.4	124.4	122	2.4	14	2
	5	□	MMS1340L-DIN-C	57.3	77.4	78.4	124.4	122	2.4	14	1
	3	★	MMS1340X3DB	42.6	70.4	72.4	128.4	126	2.4	14	1
	5	★	MMS1340X5DB	69.4	97.4	100.4	156.4	154	2.4	14	1
13.5	3	□	MMS1350S-DIN	40.2	60.5	61.5	107.5	105	2.5	14	2
	3	●	MMS1350S-DIN-C	40.2	60.5	61.5	107.5	105	2.5	14	1
	5	□	MMS1350L-DIN	57.2	77.5	78.5	124.5	122	2.5	14	2
	5	●	MMS1350L-DIN-C	57.2	77.5	78.5	124.5	122	2.5	14	1
	3	★	MMS1350X3DB	43.0	70.5	72.5	128.5	126	2.5	14	1
	5	★	MMS1350X5DB	70.0	97.5	100.5	156.5	154	2.5	14	1
13.6	3	□	MMS1360S-DIN	40.1	60.5	61.5	107.5	105	2.5	14	2
	3	□	MMS1360S-DIN-C	40.1	60.5	61.5	107.5	105	2.5	14	1
	5	□	MMS1360L-DIN	57.1	77.5	78.5	124.5	122	2.5	14	2
	5	□	MMS1360L-DIN-C	57.1	77.5	78.5	124.5	122	2.5	14	1
	3	★	MMS1360X3DB	43.3	72.5	72.5	128.5	126	2.5	14	1
	5	★	MMS1360X5DB	70.5	100.5	100.5	156.5	154	2.5	14	1
13.7	3	□	MMS1370S-DIN	39.9	60.5	61.5	107.5	105	2.5	14	2
	3	●	MMS1370S-DIN-C	39.9	60.5	61.5	107.5	105	2.5	14	1
	5	□	MMS1370L-DIN	56.9	77.5	78.5	124.5	122	2.5	14	2
	5	●	MMS1370L-DIN-C	56.9	77.5	78.5	124.5	122	2.5	14	1
	3	★	MMS1370X3DB	43.6	72.5	72.5	128.5	126	2.5	14	1
	5	★	MMS1370X5DB	71.0	100.5	100.5	156.5	154	2.5	14	1
13.8	3	□	MMS1380S-DIN	39.8	60.5	61.5	107.5	105	2.5	14	2
	3	□	MMS1380S-DIN-C	39.8	60.5	61.5	107.5	105	2.5	14	1
	5	□	MMS1380L-DIN	56.8	77.5	78.5	124.5	122	2.5	14	2
	5	□	MMS1380L-DIN-C	56.8	77.5	78.5	124.5	122	2.5	14	1
	3	★	MMS1380X3DB	43.9	72.5	72.5	128.5	126	2.5	14	1
	5	★	MMS1380X5DB	71.5	100.5	100.5	156.5	154	2.5	14	1
13.9	3	□	MMS1390S-DIN	39.7	60.5	61.5	107.5	105	2.5	14	2
	3	□	MMS1390S-DIN-C	39.7	60.5	61.5	107.5	105	2.5	14	1
	5	□	MMS1390L-DIN	56.7	77.5	78.5	124.5	122	2.5	14	2
	5	□	MMS1390L-DIN-C	56.7	77.5	78.5	124.5	122	2.5	14	1
	3	★	MMS1390X3DB	44.2	72.5	72.5	128.5	126	2.5	14	1
	5	★	MMS1390X5DB	72.0	100.5	100.5	156.5	154	2.5	14	1

DC	Głębokość otworu (L/D)	DP7020	Numer zamówieniowy	Wymiary (mm)							Typ
				LU	LCF	LH	OAL	LF	PL	DCON	
14.0	3	□	MMS1400S-DIN	39.5	60.5	61.5	107.5	105	2.5	14	2
	3	●	MMS1400S-DIN-C	39.5	60.5	61.5	107.5	105	2.5	14	1
	5	□	MMS1400L-DIN	56.5	77.5	78.5	124.5	122	2.5	14	2
	5	●	MMS1400L-DIN-C	56.5	77.5	78.5	124.5	122	2.5	14	1
	3	★	MMS1400X3DB	44.5	72.5	72.5	128.5	126	2.5	14	1
	5	★	MMS1400X5DB	72.5	100.5	100.5	156.5	154	2.5	14	1
14.05	3	□	MMS1405S-DIN	43.5	64.6	65.6	114.6	112	2.6	16	2
	3	□	MMS1405S-DIN-C	43.5	64.6	65.6	114.6	112	2.6	16	1
	5	□	MMS1405L-DIN	61.5	82.6	83.6	132.6	130	2.6	16	2
	5	□	MMS1405L-DIN-C	61.5	82.6	83.6	132.6	130	2.6	16	1
	3	□	MMS1410S-DIN	43.4	64.6	65.6	114.6	112	2.6	16	2
14.1	3	□	MMS1410S-DIN-C	43.4	64.6	65.6	114.6	112	2.6	16	1
	5	□	MMS1410L-DIN	61.4	82.6	83.6	132.6	130	2.6	16	2
	5	□	MMS1410L-DIN-C	61.4	82.6	83.6	132.6	130	2.6	16	1
	3	★	MMS1410X3DB	44.9	75.6	78.6	137.6	135	2.6	16	1
	5	★	MMS1410X5DB	73.1	104.6	108.6	167.6	165	2.6	16	1
14.2	3	□	MMS1420S-DIN	43.3	64.6	65.6	114.6	112	2.6	16	2
	3	□	MMS1420S-DIN-C	43.3	64.6	65.6	114.6	112	2.6	16	1
	5	□	MMS1420L-DIN	61.3	82.6	83.6	132.6	130	2.6	16	2
	5	□	MMS1420L-DIN-C	61.3	82.6	83.6	132.6	130	2.6	16	1
	3	★	MMS1420X3DB	45.2	75.6	78.6	137.6	135	2.6	16	1
5	★	MMS1420X5DB	73.6	104.6	108.6	167.6	165	2.6	16	1	
14.3	3	□	MMS1430S-DIN	43.2	64.6	65.6	114.6	112	2.6	16	2
	3	□	MMS1430S-DIN-C	43.2	64.6	65.6	114.6	112	2.6	16	1
	5	□	MMS1430L-DIN	61.2	82.6	83.6	132.6	130	2.6	16	2
	5	□	MMS1430L-DIN-C	61.2	82.6	83.6	132.6	130	2.6	16	1
	3	★	MMS1430X3DB	45.5	75.6	78.6	137.6	135	2.6	16	1
5	★	MMS1430X5DB	74.1	104.6	108.6	167.6	165	2.6	16	1	
14.4	3	□	MMS1440S-DIN	43.0	64.6	65.6	114.6	112	2.6	16	2
	3	□	MMS1440S-DIN-C	43.0	64.6	65.6	114.6	112	2.6	16	1
	5	□	MMS1440L-DIN	61.0	82.6	83.6	132.6	130	2.6	16	2
	5	□	MMS1440L-DIN-C	61.0	82.6	83.6	132.6	130	2.6	16	1
	3	★	MMS1440X3DB	45.8	75.6	78.6	137.6	135	2.6	16	1
5	★	MMS1440X5DB	74.6	104.6	108.6	167.6	165	2.6	16	1	
14.5	3	□	MMS1450S-DIN	42.9	64.6	65.6	114.6	112	2.6	16	2
	3	□	MMS1450S-DIN-C	42.9	64.6	65.6	114.6	112	2.6	16	1
	5	□	MMS1450L-DIN	60.9	82.6	83.6	132.6	130	2.6	16	2
	5	□	MMS1450L-DIN-C	60.9	82.6	83.6	132.6	130	2.6	16	1
	3	★	MMS1450X3DB	46.1	75.6	78.6	137.6	135	2.6	16	1
5	★	MMS1450X5DB	75.1	104.6	108.6	167.6	165	2.6	16	1	
14.6	3	□	MMS1460S-DIN	42.8	64.7	65.7	114.7	112	2.7	16	2
	3	□	MMS1460S-DIN-C	42.8	64.7	65.7	114.7	112	2.7	16	1
	5	□	MMS1460L-DIN	60.8	82.7	83.7	132.7	130	2.7	16	2
	5	□	MMS1460L-DIN-C	60.8	82.7	83.7	132.7	130	2.7	16	1
	3	★	MMS1460X3DB	46.5	77.7	78.7	137.7	135	2.7	16	1
5	★	MMS1460X5DB	75.7	107.7	108.7	167.7	165	2.7	16	1	
14.7	3	□	MMS1470S-DIN	42.6	64.7	65.7	114.7	112	2.7	16	2
	3	□	MMS1470S-DIN-C	42.6	64.7	65.7	114.7	112	2.7	16	1
	5	□	MMS1470L-DIN	60.6	82.7	83.7	132.7	130	2.7	16	2
	5	□	MMS1470L-DIN-C	60.6	82.7	83.7	132.7	130	2.7	16	1
	3	★	MMS1470X3DB	46.8	77.7	78.7	137.7	135	2.7	16	1
5	★	MMS1470X5DB	76.2	107.7	108.7	167.7	165	2.7	16	1	

WIERCENIE (WIERTŁA PEŁNOWĘGLIKOWE)

MMS

WĘGLIKI
SPIEKANE

WIERCENIE

M

DC (mm)	Głębokość otworu (L/D)	DP7020	Numer zamówieniowy	Wymiary (mm)							Typ
				LU	LCF	LH	OAL	LF	PL	DCON	
14.8	3	<input type="checkbox"/>	MMS1480S-DIN	42.5	64.7	65.7	114.7	112	2.7	16	2
	3	<input type="checkbox"/>	MMS1480S-DIN-C	42.5	64.7	65.7	114.7	112	2.7	16	1
	5	<input type="checkbox"/>	MMS1480L-DIN	60.5	82.7	83.7	132.7	130	2.7	16	2
	5	<input type="checkbox"/>	MMS1480L-DIN-C	60.5	82.7	83.7	132.7	130	2.7	16	1
	3	<input checked="" type="checkbox"/>	MMS1480X3DB	47.1	77.7	78.7	137.7	135	2.7	16	1
	5	<input checked="" type="checkbox"/>	MMS1480X5DB	76.7	107.7	108.7	167.7	165	2.7	16	1
14.9	3	<input type="checkbox"/>	MMS1490S-DIN	42.4	64.7	65.7	114.7	112	2.7	16	2
	3	<input type="checkbox"/>	MMS1490S-DIN-C	42.4	64.7	65.7	114.7	112	2.7	16	1
	5	<input type="checkbox"/>	MMS1490L-DIN	60.4	82.7	83.7	132.7	130	2.7	16	2
	5	<input type="checkbox"/>	MMS1490L-DIN-C	60.4	82.7	83.7	132.7	130	2.7	16	1
	3	<input checked="" type="checkbox"/>	MMS1490X3DB	47.4	77.7	78.7	137.7	135	2.7	16	1
	5	<input checked="" type="checkbox"/>	MMS1490X5DB	77.2	107.7	108.7	167.7	165	2.7	16	1
15.0	3	<input type="checkbox"/>	MMS1500S-DIN	42.2	64.7	65.7	114.7	112	2.7	16	2
	3	<input type="checkbox"/>	MMS1500S-DIN-C	42.2	64.7	65.7	114.7	112	2.7	16	1
	5	<input type="checkbox"/>	MMS1500L-DIN	60.2	82.7	83.7	132.7	130	2.7	16	2
	5	<input type="checkbox"/>	MMS1500L-DIN-C	60.2	82.7	83.7	132.7	130	2.7	16	1
	3	<input checked="" type="checkbox"/>	MMS1500X3DB	47.7	77.7	78.7	137.7	135	2.7	16	1
	5	<input checked="" type="checkbox"/>	MMS1500X5DB	77.7	107.7	108.7	167.7	165	2.7	16	1
15.1	3	<input type="checkbox"/>	MMS1510S-DIN	42.1	64.7	65.7	114.7	112	2.7	16	2
	3	<input type="checkbox"/>	MMS1510S-DIN-C	42.1	64.7	65.7	114.7	112	2.7	16	1
	5	<input type="checkbox"/>	MMS1510L-DIN	60.1	82.7	83.7	132.7	130	2.7	16	2
	5	<input type="checkbox"/>	MMS1510L-DIN-C	60.1	82.7	83.7	132.7	130	2.7	16	1
	3	<input checked="" type="checkbox"/>	MMS1510X3DB	48.0	80.7	82.7	141.7	139	2.7	16	1
	5	<input checked="" type="checkbox"/>	MMS1510X5DB	78.2	111.7	114.7	173.7	171	2.7	16	1
15.2	3	<input type="checkbox"/>	MMS1520S-DIN	42.0	64.8	65.8	114.8	112	2.8	16	2
	3	<input type="checkbox"/>	MMS1520S-DIN-C	42.0	64.8	65.8	114.8	112	2.8	16	1
	5	<input type="checkbox"/>	MMS1520L-DIN	60.0	82.8	83.8	132.8	130	2.8	16	2
	5	<input type="checkbox"/>	MMS1520L-DIN-C	60.0	82.8	83.8	132.8	130	2.8	16	1
	3	<input checked="" type="checkbox"/>	MMS1520X3DB	48.4	80.8	82.8	141.8	139	2.8	16	1
	5	<input checked="" type="checkbox"/>	MMS1520X5DB	78.8	111.8	114.8	173.8	171	2.8	16	1
15.3	3	<input type="checkbox"/>	MMS1530S-DIN	41.8	64.8	65.8	114.8	112	2.8	16	2
	3	<input type="checkbox"/>	MMS1530S-DIN-C	41.8	64.8	65.8	114.8	112	2.8	16	1
	5	<input type="checkbox"/>	MMS1530L-DIN	59.8	82.8	83.8	132.8	130	2.8	16	2
	5	<input type="checkbox"/>	MMS1530L-DIN-C	59.8	82.8	83.8	132.8	130	2.8	16	1
	3	<input checked="" type="checkbox"/>	MMS1530X3DB	48.7	80.8	82.8	141.8	139	2.8	16	1
	5	<input checked="" type="checkbox"/>	MMS1530X5DB	79.3	111.8	114.8	173.8	171	2.8	16	1
15.4	3	<input type="checkbox"/>	MMS1540S-DIN	41.7	64.8	65.8	114.8	112	2.8	16	2
	3	<input type="checkbox"/>	MMS1540S-DIN-C	41.7	64.8	65.8	114.8	112	2.8	16	1
	5	<input type="checkbox"/>	MMS1540L-DIN	59.7	82.8	83.8	132.8	130	2.8	16	2
	5	<input type="checkbox"/>	MMS1540L-DIN-C	59.7	82.8	83.8	132.8	130	2.8	16	1
	3	<input checked="" type="checkbox"/>	MMS1540X3DB	49.0	80.8	82.8	141.8	139	2.8	16	1
	5	<input checked="" type="checkbox"/>	MMS1540X5DB	79.8	111.8	114.8	173.8	171	2.8	16	1
15.5	3	<input type="checkbox"/>	MMS1550S-DIN	41.6	64.8	65.8	114.8	112	2.8	16	2
	3	<input type="checkbox"/>	MMS1550S-DIN-C	41.6	64.8	65.8	114.8	112	2.8	16	1
	5	<input type="checkbox"/>	MMS1550L-DIN	59.6	82.8	83.8	132.8	130	2.8	16	2
	5	<input type="checkbox"/>	MMS1550L-DIN-C	59.6	82.8	83.8	132.8	130	2.8	16	1
	3	<input checked="" type="checkbox"/>	MMS1550X3DB	49.3	80.8	82.8	141.8	139	2.8	16	1
	5	<input checked="" type="checkbox"/>	MMS1550X5DB	80.3	111.8	114.8	173.8	171	2.8	16	1

DC (mm)	Głębokość otworu (L/D)	DP7020	Numer zamówieniowy	Wymiary (mm)							Typ
				LU	LCF	LH	OAL	LF	PL	DCON	
15.6	3	<input type="checkbox"/>	MMS1560S-DIN	41.4	64.8	65.8	114.8	112	2.8	16	2
	3	<input type="checkbox"/>	MMS1560S-DIN-C	41.4	64.8	65.8	114.8	112	2.8	16	1
	5	<input type="checkbox"/>	MMS1560L-DIN	59.4	82.8	83.8	132.8	130	2.8	16	2
	5	<input type="checkbox"/>	MMS1560L-DIN-C	59.4	82.8	83.8	132.8	130	2.8	16	1
	3	<input checked="" type="checkbox"/>	MMS1560X3DB	49.6	82.8	82.8	141.8	139	2.8	16	1
	5	<input checked="" type="checkbox"/>	MMS1560X5DB	80.8	114.8	114.8	173.8	171	2.8	16	1
15.7	3	<input type="checkbox"/>	MMS1570S-DIN	41.3	64.9	65.9	114.9	112	2.9	16	2
	3	<input type="checkbox"/>	MMS1570S-DIN-C	41.3	64.9	65.9	114.9	112	2.9	16	1
	5	<input type="checkbox"/>	MMS1570L-DIN	59.3	82.9	83.9	132.9	130	2.9	16	2
	5	<input type="checkbox"/>	MMS1570L-DIN-C	59.3	82.9	83.9	132.9	130	2.9	16	1
	3	<input checked="" type="checkbox"/>	MMS1570X3DB	50.0	82.9	82.9	141.9	139	2.9	16	1
	5	<input checked="" type="checkbox"/>	MMS1570X5DB	81.4	114.9	114.9	173.9	171	2.9	16	1
15.8	3	<input type="checkbox"/>	MMS1580S-DIN	41.2	64.9	65.9	114.9	112	2.9	16	2
	3	<input type="checkbox"/>	MMS1580S-DIN-C	41.2	64.9	65.9	114.9	112	2.9	16	1
	5	<input type="checkbox"/>	MMS1580L-DIN	59.2	82.9	83.9	132.9	130	2.9	16	2
	5	<input type="checkbox"/>	MMS1580L-DIN-C	59.2	82.9	83.9	132.9	130	2.9	16	1
	3	<input checked="" type="checkbox"/>	MMS1580X3DB	50.3	82.9	82.9	141.9	139	2.9	16	1
	5	<input checked="" type="checkbox"/>	MMS1580X5DB	81.9	114.9	114.9	173.9	171	2.9	16	1
15.9	3	<input type="checkbox"/>	MMS1590S-DIN	41.0	64.9	65.9	114.9	112	2.9	16	2
	3	<input type="checkbox"/>	MMS1590S-DIN-C	41.0	64.9	65.9	114.9	112	2.9	16	1
	5	<input type="checkbox"/>	MMS1590L-DIN	59.0	82.9	83.9	132.9	130	2.9	16	2
	5	<input type="checkbox"/>	MMS1590L-DIN-C	59.0	82.9	83.9	132.9	130	2.9	16	1
	3	<input checked="" type="checkbox"/>	MMS1590X3DB	50.6	82.9	82.9	141.9	139	2.9	16	1
	5	<input checked="" type="checkbox"/>	MMS1590X5DB	82.4	114.9	114.9	173.9	171	2.9	16	1
16.0	3	<input type="checkbox"/>	MMS1600S-DIN	40.9	64.9	65.9	114.9	112	2.9	16	2
	3	<input type="checkbox"/>	MMS1600S-DIN-C	40.9	64.9	65.9	114.9	112	2.9	16	1
	5	<input type="checkbox"/>	MMS1600L-DIN	58.9	82.9	83.9	132.9	130	2.9	16	2
	5	<input type="checkbox"/>	MMS1600L-DIN-C	58.9	82.9	83.9	132.9	130	2.9	16	1
	3	<input checked="" type="checkbox"/>	MMS1600X3DB	50.9	82.9	82.9	141.9	139	2.9	16	1
	5	<input checked="" type="checkbox"/>	MMS1600X5DB	82.9	114.9	114.9	173.9	171	2.9	16	1
16.1	3	<input type="checkbox"/>	MMS1610S-DIN	48.8	72.9	73.9	122.9	120	2.9	18	2
	3	<input type="checkbox"/>	MMS1610S-DIN-C	48.8	72.9	73.9	122.9	120	2.9	18	1
	5	<input type="checkbox"/>	MMS1610L-DIN	68.8	92.9	93.9	142.9	140	2.9	18	2
	5	<input type="checkbox"/>	MMS1610L-DIN-C	68.8	92.9	93.9	142.9	140	2.9	18	1
	3	<input type="checkbox"/>	MMS1610X3DB	51.2	85.9	88.9	147.9	145	2.9	18	1
	5	<input type="checkbox"/>	MMS1610X5DB	83.4	118.9	122.9	181.9	179	2.9	18	1
16.2	3	<input type="checkbox"/>	MMS1620S-DIN	48.6	72.9	73.9	122.9	120	2.9	18	2
	3	<input type="checkbox"/>	MMS1620S-DIN-C	48.6	72.9	73.9	122.9	120	2.9	18	1
	5	<input type="checkbox"/>	MMS1620L-DIN	68.6	92.9	93.9	142.9	140	2.9	18	2
	5	<input type="checkbox"/>	MMS1620L-DIN-C	68.6	92.9	93.9	142.9	140	2.9	18	1
	3	<input type="checkbox"/>	MMS1620X3DB	51.5	85.9	88.9	147.9	145	2.9	18	1
	5	<input type="checkbox"/>	MMS1620X5DB	83.9	118.9	122.9	181.9	179	2.9	18	1
16.3	3	<input type="checkbox"/>	MMS1630S-DIN	48.5	73.0	74.0	123.0	120	3.0	18	2
	3	<input type="checkbox"/>	MMS1630S-DIN-C	48.5	73.0	74.0	123.0	120	3.0	18	1
	5	<input type="checkbox"/>	MMS1630L-DIN	68.5	93.0	94.0	143.0	140	3.0	18	2
	5	<input type="checkbox"/>	MMS1630L-DIN-C	68.5	93.0	94.0	143.0	140	3.0	18	1
	3	<input type="checkbox"/>	MMS1630X3DB	51.9	86.0	89.0	148.0	145	3.0	18	1
	5	<input type="checkbox"/>	MMS1630X5DB	84.5	119.0	123.0	182.0	179	3.0	18	1

★ : Na specjalne zamówienie z magazynu w Japonii. □ : Niestandardowy, produkowany na specjalne zamówienie.

DC (mm)	Głębokość otworu (L/D)	DP7020	Numer zamówieniowy	Wymiary (mm)							Typ
				LU	LCF	LH	OAL	LF	PL	DCON	
16.4	3	□	MMS1640S-DIN	48.4	73.0	74.0	123.0	120	3.0	18	2
	3	□	MMS1640S-DIN-C	48.4	73.0	74.0	123.0	120	3.0	18	1
	5	□	MMS1640L-DIN	68.4	93.0	94.0	143.0	140	3.0	18	2
	5	□	MMS1640L-DIN-C	68.4	93.0	94.0	143.0	140	3.0	18	1
	3	□	MMS1640X3DB	52.2	86.0	89.0	148.0	145	3.0	18	1
	5	□	MMS1640X5DB	85.0	119.0	123.0	182.0	179	3.0	18	1
16.5	3	□	MMS1650S-DIN	48.3	73.0	74.0	123.0	120	3.0	18	2
	3	□	MMS1650S-DIN-C	48.3	73.0	74.0	123.0	120	3.0	18	1
	5	□	MMS1650L-DIN	68.3	93.0	94.0	143.0	140	3.0	18	2
	5	□	MMS1650L-DIN-C	68.3	93.0	94.0	143.0	140	3.0	18	1
	3	★	MMS1650X3DB	52.5	86.0	89.0	148.0	145	3.0	18	1
	5	★	MMS1650X5DB	85.5	119.0	123.0	182.0	179	3.0	18	1
16.6	3	□	MMS1660S-DIN	48.1	73.0	74.0	123.0	120	3.0	18	2
	3	□	MMS1660S-DIN-C	48.1	73.0	74.0	123.0	120	3.0	18	1
	5	□	MMS1660L-DIN	68.1	93.0	94.0	143.0	140	3.0	18	2
	5	□	MMS1660L-DIN-C	68.1	93.0	94.0	143.0	140	3.0	18	1
	3	□	MMS1660X3DB	52.8	88.0	89.0	148.0	145	3.0	18	1
	5	□	MMS1660X5DB	86.0	122.0	123.0	182.0	179	3.0	18	1
16.7	3	□	MMS1670S-DIN	48.0	73.0	74.0	123.0	120	3.0	18	2
	3	□	MMS1670S-DIN-C	48.0	73.0	74.0	123.0	120	3.0	18	1
	5	□	MMS1670L-DIN	68.0	93.0	94.0	143.0	140	3.0	18	2
	5	□	MMS1670L-DIN-C	68.0	93.0	94.0	143.0	140	3.0	18	1
	3	□	MMS1670X3DB	53.1	88.0	89.0	148.0	145	3.0	18	1
	5	□	MMS1670X5DB	86.5	122.0	123.0	182.0	179	3.0	18	1
16.8	3	□	MMS1680S-DIN	47.9	73.1	74.1	123.1	120	3.1	18	2
	3	□	MMS1680S-DIN-C	47.9	73.1	74.1	123.1	120	3.1	18	1
	5	□	MMS1680L-DIN	67.9	93.1	94.1	143.1	140	3.1	18	2
	5	□	MMS1680L-DIN-C	67.9	93.1	94.1	143.1	140	3.1	18	1
	3	□	MMS1680X3DB	53.5	88.1	89.1	148.1	145	3.1	18	1
	5	□	MMS1680X5DB	87.1	122.1	123.1	182.1	179	3.1	18	1
16.9	3	□	MMS1690S-DIN	47.7	73.1	74.1	123.1	120	3.1	18	2
	3	□	MMS1690S-DIN-C	47.7	73.1	74.1	123.1	120	3.1	18	1
	5	□	MMS1690L-DIN	67.7	93.1	94.1	143.1	140	3.1	18	2
	5	□	MMS1690L-DIN-C	67.7	93.1	94.1	143.1	140	3.1	18	1
	3	□	MMS1690X3DB	53.8	88.1	89.1	148.1	145	3.1	18	1
	5	□	MMS1690X5DB	87.6	122.1	123.1	182.1	179	3.1	18	1
17.0	3	□	MMS1700S-DIN	47.6	73.1	74.1	123.1	120	3.1	18	2
	3	□	MMS1700S-DIN-C	47.6	73.1	74.1	123.1	120	3.1	18	1
	5	□	MMS1700L-DIN	67.6	93.1	94.1	143.1	140	3.1	18	2
	5	□	MMS1700L-DIN-C	67.6	93.1	94.1	143.1	140	3.1	18	1
	3	★	MMS1700X3DB	54.1	88.1	89.1	148.1	145	3.1	18	1
	5	★	MMS1700X5DB	88.1	122.1	123.1	182.1	179	3.1	18	1
17.1	3	□	MMS1710S-DIN	47.5	73.1	74.1	123.1	120	3.1	18	2
	3	□	MMS1710S-DIN-C	47.5	73.1	74.1	123.1	120	3.1	18	1
	5	□	MMS1710L-DIN	67.5	93.1	94.1	143.1	140	3.1	18	2
	5	□	MMS1710L-DIN-C	67.5	93.1	94.1	143.1	140	3.1	18	1
	3	□	MMS1710X3DB	54.4	91.1	93.1	152.1	149	3.1	18	1
	5	□	MMS1710X5DB	88.6	126.1	129.1	188.1	185	3.1	18	1

DC (mm)	Głębokość otworu (L/D)	DP7020	Numer zamówieniowy	Wymiary (mm)							Typ
				LU	LCF	LH	OAL	LF	PL	DCON	
17.2	3	□	MMS1720S-DIN	47.3	73.1	74.1	123.1	120	3.1	18	2
	3	□	MMS1720S-DIN-C	47.3	73.1	74.1	123.1	120	3.1	18	1
	5	□	MMS1720L-DIN	67.3	93.1	94.1	143.1	140	3.1	18	2
	5	□	MMS1720L-DIN-C	67.3	93.1	94.1	143.1	140	3.1	18	1
	3	□	MMS1720X3DB	54.7	91.1	93.1	152.1	149	3.1	18	1
	5	□	MMS1720X5DB	89.1	126.1	129.1	188.1	185	3.1	18	1
17.3	3	□	MMS1730S-DIN	47.2	73.1	74.1	123.1	120	3.1	18	2
	3	□	MMS1730S-DIN-C	47.2	73.1	74.1	123.1	120	3.1	18	1
	5	□	MMS1730L-DIN	67.2	93.1	94.1	143.1	140	3.1	18	2
	5	□	MMS1730L-DIN-C	67.2	93.1	94.1	143.1	140	3.1	18	1
	3	□	MMS1730X3DB	55.0	91.1	93.1	152.1	149	3.1	18	1
	5	□	MMS1730X5DB	89.6	126.1	129.1	188.1	185	3.1	18	1
17.4	3	□	MMS1740S-DIN	47.1	73.2	74.2	123.2	120	3.2	18	2
	3	□	MMS1740S-DIN-C	47.1	73.2	74.2	123.2	120	3.2	18	1
	5	□	MMS1740L-DIN	67.1	93.2	94.2	143.2	140	3.2	18	2
	5	□	MMS1740L-DIN-C	67.1	93.2	94.2	143.2	140	3.2	18	1
	3	□	MMS1740X3DB	55.4	91.2	93.2	152.2	149	3.2	18	1
	5	□	MMS1740X5DB	90.2	126.2	129.2	188.2	185	3.2	18	1
17.5	3	□	MMS1750S-DIN	46.9	73.2	74.2	123.2	120	3.2	18	2
	3	□	MMS1750S-DIN-C	46.9	73.2	74.2	123.2	120	3.2	18	1
	5	□	MMS1750L-DIN	66.9	93.2	94.2	143.2	140	3.2	18	2
	5	□	MMS1750L-DIN-C	66.9	93.2	94.2	143.2	140	3.2	18	1
	3	★	MMS1750X3DB	55.7	91.2	93.2	152.2	149	3.2	18	1
	5	★	MMS1750X5DB	90.7	126.2	129.2	188.2	185	3.2	18	1
17.6	3	□	MMS1760S-DIN	46.8	73.2	74.2	123.2	120	3.2	18	2
	3	□	MMS1760S-DIN-C	46.8	73.2	74.2	123.2	120	3.2	18	1
	5	□	MMS1760L-DIN	66.8	93.2	94.2	143.2	140	3.2	18	2
	5	□	MMS1760L-DIN-C	66.8	93.2	94.2	143.2	140	3.2	18	1
	3	□	MMS1760X3DB	56.0	93.2	93.2	152.2	149	3.2	18	1
	5	□	MMS1760X5DB	91.2	129.2	129.2	188.2	185	3.2	18	1
17.7	3	□	MMS1770S-DIN	46.7	73.2	74.2	123.2	120	3.2	18	2
	3	□	MMS1770S-DIN-C	46.7	73.2	74.2	123.2	120	3.2	18	1
	5	□	MMS1770L-DIN	66.7	93.2	94.2	143.2	140	3.2	18	2
	5	□	MMS1770L-DIN-C	66.7	93.2	94.2	143.2	140	3.2	18	1
	3	□	MMS1770X3DB	56.3	93.2	93.2	152.2	149	3.2	18	1
	5	□	MMS1770X5DB	91.7	129.2	129.2	188.2	185	3.2	18	1
17.8	3	□	MMS1780S-DIN	46.5	73.2	74.2	123.2	120	3.2	18	2
	3	□	MMS1780S-DIN-C	46.5	73.2	74.2	123.2	120	3.2	18	1
	5	□	MMS1780L-DIN	66.5	93.2	94.2	143.2	140	3.2	18	2
	5	□	MMS1780L-DIN-C	66.5	93.2	94.2	143.2	140	3.2	18	1
	3	□	MMS1780X3DB	56.6	93.2	93.2	152.2	149	3.2	18	1
	5	□	MMS1780X5DB	92.2	129.2	129.2	188.2	185	3.2	18	1
17.9	3	□	MMS1790S-DIN	46.4	73.3	74.3	123.3	120	3.3	18	2
	3	□	MMS1790S-DIN-C	46.4	73.3	74.3	123.3	120	3.3	18	1
	5	□	MMS1790L-DIN	66.4	93.3	94.3	143.3	140	3.3	18	2
	5	□	MMS1790L-DIN-C	66.4	93.3	94.3	143.3	140	3.3	18	1
	3	□	MMS1790X3DB	57.0	93.3	93.3	152.3	149	3.3	18	1
	5	□	MMS1790X5DB	92.8	129.3	129.3	188.3	185	3.3	18	1

WIERCENIE (WIERTŁA PEŁNOWĘGLIKOWE)

MMS

WĘGLIKI
SPIEKANE

WIERCENIE

M

DC (mm)	Głębokość otworu (L/D)	DP7020	Numer zamówieniowy	Wymiary (mm)								Typ
				LU	LCF	LH	OAL	LF	PL	DCON		
18.0	3	<input type="checkbox"/>	MMS1800S-DIN	46.3	73.3	74.3	123.3	120	3.3	18	2	
	3	<input type="checkbox"/>	MMS1800S-DIN-C	46.3	73.3	74.3	123.3	120	3.3	18	1	
	5	<input type="checkbox"/>	MMS1800L-DIN	66.3	93.3	94.3	143.3	140	3.3	18	2	
	5	<input type="checkbox"/>	MMS1800L-DIN-C	66.3	93.3	94.3	143.3	140	3.3	18	1	
	3	★	MMS1800X3DB	57.3	93.3	93.3	152.3	149	3.3	18	1	
	5	★	MMS1800X5DB	93.3	129.3	129.3	188.3	185	3.3	18	1	
18.1	3	<input type="checkbox"/>	MMS1810S-DIN	52.1	79.3	80.3	131.3	128	3.3	20	2	
	3	<input type="checkbox"/>	MMS1810S-DIN-C	52.1	79.3	80.3	131.3	128	3.3	20	1	
	5	<input type="checkbox"/>	MMS1810L-DIN	74.1	101.3	102.3	153.3	150	3.3	20	2	
	5	<input type="checkbox"/>	MMS1810L-DIN-C	74.1	101.3	102.3	153.3	150	3.3	20	1	
	3	<input type="checkbox"/>	MMS1810X3DB	57.6	96.3	99.3	160.3	157	3.3	20	1	
	5	<input type="checkbox"/>	MMS1810X5DB	93.8	133.3	137.3	198.3	195	3.3	20	1	
18.2	3	<input type="checkbox"/>	MMS1820S-DIN	52.0	79.3	80.3	131.3	128	3.3	20	2	
	3	<input type="checkbox"/>	MMS1820S-DIN-C	52.0	79.3	80.3	131.3	128	3.3	20	1	
	5	<input type="checkbox"/>	MMS1820L-DIN	74.0	101.3	102.3	153.3	150	3.3	20	2	
	5	<input type="checkbox"/>	MMS1820L-DIN-C	74.0	101.3	102.3	153.3	150	3.3	20	1	
	3	<input type="checkbox"/>	MMS1820X3DB	57.9	96.3	99.3	160.3	157	3.3	20	1	
	5	<input type="checkbox"/>	MMS1820X5DB	94.3	133.3	137.3	198.3	195	3.3	20	1	
18.3	3	<input type="checkbox"/>	MMS1830S-DIN	51.9	79.3	80.3	131.3	128	3.3	20	2	
	3	<input type="checkbox"/>	MMS1830S-DIN-C	51.9	79.3	80.3	131.3	128	3.3	20	1	
	5	<input type="checkbox"/>	MMS1830L-DIN	73.9	101.3	102.3	153.3	150	3.3	20	2	
	5	<input type="checkbox"/>	MMS1830L-DIN-C	73.9	101.3	102.3	153.3	150	3.3	20	1	
	3	<input type="checkbox"/>	MMS1830X3DB	58.2	96.3	99.3	160.3	157	3.3	20	1	
	5	<input type="checkbox"/>	MMS1830X5DB	94.8	133.3	137.3	198.3	195	3.3	20	1	
18.4	3	<input type="checkbox"/>	MMS1840S-DIN	51.7	79.3	80.3	131.3	128	3.3	20	2	
	3	<input type="checkbox"/>	MMS1840S-DIN-C	51.7	79.3	80.3	131.3	128	3.3	20	1	
	5	<input type="checkbox"/>	MMS1840L-DIN	73.7	101.3	102.3	153.3	150	3.3	20	2	
	5	<input type="checkbox"/>	MMS1840L-DIN-C	73.7	101.3	102.3	153.3	150	3.3	20	1	
	3	<input type="checkbox"/>	MMS1840X3DB	58.5	96.3	99.3	160.3	157	3.3	20	1	
	5	<input type="checkbox"/>	MMS1840X5DB	95.3	133.3	137.3	198.3	195	3.3	20	1	
18.5	3	<input type="checkbox"/>	MMS1850S-DIN	51.6	79.4	80.4	131.4	128	3.4	20	2	
	3	<input type="checkbox"/>	MMS1850S-DIN-C	51.6	79.4	80.4	131.4	128	3.4	20	1	
	5	<input type="checkbox"/>	MMS1850L-DIN	73.6	101.4	102.4	153.4	150	3.4	20	2	
	5	<input type="checkbox"/>	MMS1850L-DIN-C	73.6	101.4	102.4	153.4	150	3.4	20	1	
	3	★	MMS1850X3DB	58.9	96.4	99.4	160.4	157	3.4	20	1	
	5	★	MMS1850X5DB	95.9	133.4	137.4	198.4	195	3.4	20	1	
18.6	3	<input type="checkbox"/>	MMS1860S-DIN	51.5	79.4	80.4	131.4	128	3.4	20	2	
	3	<input type="checkbox"/>	MMS1860S-DIN-C	51.5	79.4	80.4	131.4	128	3.4	20	1	
	5	<input type="checkbox"/>	MMS1860L-DIN	73.5	101.4	102.4	153.4	150	3.4	20	2	
	5	<input type="checkbox"/>	MMS1860L-DIN-C	73.5	101.4	102.4	153.4	150	3.4	20	1	
	3	<input type="checkbox"/>	MMS1860X3DB	59.2	98.4	99.4	160.4	157	3.4	20	1	
	5	<input type="checkbox"/>	MMS1860X5DB	96.4	136.4	137.4	198.4	195	3.4	20	1	
18.7	3	<input type="checkbox"/>	MMS1870S-DIN	51.4	79.4	80.4	131.4	128	3.4	20	2	
	3	<input type="checkbox"/>	MMS1870S-DIN-C	51.4	79.4	80.4	131.4	128	3.4	20	1	
	5	<input type="checkbox"/>	MMS1870L-DIN	73.4	101.4	102.4	153.4	150	3.4	20	2	
	5	<input type="checkbox"/>	MMS1870L-DIN-C	73.4	101.4	102.4	153.4	150	3.4	20	1	
	3	<input type="checkbox"/>	MMS1870X3DB	59.5	98.4	99.4	160.4	157	3.4	20	1	
	5	<input type="checkbox"/>	MMS1870X5DB	96.9	136.4	137.4	198.4	195	3.4	20	1	

DC (mm)	Głębokość otworu (L/D)	DP7020	Numer zamówieniowy	Wymiary (mm)								Typ
				LU	LCF	LH	OAL	LF	PL	DCON		
18.8	3	<input type="checkbox"/>	MMS1880S-DIN	51.2	79.4	80.4	131.4	128	3.4	20	2	
	3	<input type="checkbox"/>	MMS1880S-DIN-C	51.2	79.4	80.4	131.4	128	3.4	20	1	
	5	<input type="checkbox"/>	MMS1880L-DIN	73.2	101.4	102.4	153.4	150	3.4	20	2	
	5	<input type="checkbox"/>	MMS1880L-DIN-C	73.2	101.4	102.4	153.4	150	3.4	20	1	
	3	<input type="checkbox"/>	MMS1880X3DB	59.8	98.4	99.4	160.4	157	3.4	20	1	
	5	<input type="checkbox"/>	MMS1880X5DB	97.4	136.4	137.4	198.4	195	3.4	20	1	
18.9	3	<input type="checkbox"/>	MMS1890S-DIN	51.1	79.4	80.4	131.4	128	3.4	20	2	
	3	<input type="checkbox"/>	MMS1890S-DIN-C	51.1	79.4	80.4	131.4	128	3.4	20	1	
	5	<input type="checkbox"/>	MMS1890L-DIN	73.1	101.4	102.4	153.4	150	3.4	20	2	
	5	<input type="checkbox"/>	MMS1890L-DIN-C	73.1	101.4	102.4	153.4	150	3.4	20	1	
	3	<input type="checkbox"/>	MMS1890X3DB	60.1	98.4	99.4	160.4	157	3.4	20	1	
	5	<input type="checkbox"/>	MMS1890X5DB	97.9	136.4	137.4	198.4	195	3.4	20	1	
19.0	3	<input type="checkbox"/>	MMS1900S-DIN	51.0	79.5	80.5	131.5	128	3.5	20	2	
	3	<input type="checkbox"/>	MMS1900S-DIN-C	51.0	79.5	80.5	131.5	128	3.5	20	1	
	5	<input type="checkbox"/>	MMS1900L-DIN	73.0	101.5	102.5	153.5	150	3.5	20	2	
	5	<input type="checkbox"/>	MMS1900L-DIN-C	73.0	101.5	102.5	153.5	150	3.5	20	1	
	3	★	MMS1900X3DB	60.5	98.5	99.5	160.5	157	3.5	20	1	
	5	★	MMS1900X5DB	98.5	136.5	137.5	198.5	195	3.5	20	1	
19.1	3	<input type="checkbox"/>	MMS1910S-DIN	50.8	79.5	80.5	131.5	128	3.5	20	2	
	3	<input type="checkbox"/>	MMS1910S-DIN-C	50.8	79.5	80.5	131.5	128	3.5	20	1	
	5	<input type="checkbox"/>	MMS1910L-DIN	72.8	101.5	102.5	153.5	150	3.5	20	2	
	5	<input type="checkbox"/>	MMS1910L-DIN-C	72.8	101.5	102.5	153.5	150	3.5	20	1	
	3	<input type="checkbox"/>	MMS1910X3DB	60.8	101.5	103.5	164.5	161	3.5	20	1	
	5	<input type="checkbox"/>	MMS1910X5DB	99.0	140.5	143.5	204.5	201	3.5	20	1	
19.2	3	<input type="checkbox"/>	MMS1920S-DIN	50.7	79.5	80.5	131.5	128	3.5	20	2	
	3	<input type="checkbox"/>	MMS1920S-DIN-C	50.7	79.5	80.5	131.5	128	3.5	20	1	
	5	<input type="checkbox"/>	MMS1920L-DIN	72.7	101.5	102.5	153.5	150	3.5	20	2	
	5	<input type="checkbox"/>	MMS1920L-DIN-C	72.7	101.5	102.5	153.5	150	3.5	20	1	
	3	<input type="checkbox"/>	MMS1920X3DB	61.1	101.5	103.5	164.5	161	3.5	20	1	
	5	<input type="checkbox"/>	MMS1920X5DB	99.5	140.5	143.5	204.5	201	3.5	20	1	
19.3	3	<input type="checkbox"/>	MMS1930S-DIN	50.6	79.5	80.5	131.5	128	3.5	20	2	
	3	<input type="checkbox"/>	MMS1930S-DIN-C	50.6	79.5	80.5	131.5	128	3.5	20	1	
	5	<input type="checkbox"/>	MMS1930L-DIN	72.6	101.5	102.5	153.5	150	3.5	20	2	
	5	<input type="checkbox"/>	MMS1930L-DIN-C	72.6	101.5	102.5	153.5	150	3.5	20	1	
	3	<input type="checkbox"/>	MMS1930X3DB	61.4	101.5	103.5	164.5	161	3.5	20	1	
	5	<input type="checkbox"/>	MMS1930X5DB	100.0	140.5	143.5	204.5	201	3.5	20	1	
19.4	3	<input type="checkbox"/>	MMS1940S-DIN	50.4	79.5	80.5	131.5	128	3.5	20	2	
	3	<input type="checkbox"/>	MMS1940S-DIN-C	50.4	79.5	80.5	131.5	128	3.5	20	1	
	5	<input type="checkbox"/>	MMS1940L-DIN	72.4	101.5	102.5	153.5	150	3.5	20	2	
	5	<input type="checkbox"/>	MMS1940L-DIN-C	72.4	101.5	102.5	153.5	150	3.5	20	1	
	3	<input type="checkbox"/>	MMS1940X3DB	61.7	101.5	103.5	164.5	161	3.5	20	1	
	5	<input type="checkbox"/>	MMS1940X5DB	100.5	140.5	143.5	204.5	201	3.5	20	1	
19.5	3	<input type="checkbox"/>	MMS1950S-DIN	50.3	79.5	80.5	131.5	128	3.5	20	2	
	3	<input type="checkbox"/>	MMS1950S-DIN-C	50.3	79.5	80.5	131.5	128	3.5	20	1	
	5	<input type="checkbox"/>	MMS1950L-DIN	72.3	101.5	102.5	153.5	150	3.5	20	2	
	5	<input type="checkbox"/>	MMS1950L-DIN-C	72.3	101.5	102.5	153.5	150	3.5	20	1	
	3	★	MMS1950X3DB	62.0	101.5	103.5	164.5	161	3.5	20	1	
	5	★	MMS1950X5DB	101.0	140.5	143.5	204.5	201	3.5	20	1	

★ : Na specjalne zamówienie z magazynu w Japonii. □ : Niestandardowy, produkowany na specjalne zamówienie.

DC (mm)	Głębokość otworu (L/D)	DP7020	Numer zamówieniowy	Wymiary (mm)							Typ
				LU	LCF	LH	OAL	LF	PL	DCON	
19.6	3	□	MMS1960S-DIN	50.2	79.6	80.6	131.6	128	3.6	20	2
	3	□	MMS1960S-DIN-C	50.2	79.6	80.6	131.6	128	3.6	20	1
	5	□	MMS1960L-DIN	72.2	101.6	102.6	153.6	150	3.6	20	2
	5	□	MMS1960L-DIN-C	72.2	101.6	102.6	153.6	150	3.6	20	1
	3	□	MMS1960X3DB	62.4	103.6	103.6	164.6	161	3.6	20	1
	5	□	MMS1960X5DB	101.6	143.6	143.6	204.6	201	3.6	20	1
19.7	3	□	MMS1970S-DIN	50.0	79.6	80.6	131.6	128	3.6	20	2
	3	□	MMS1970S-DIN-C	50.0	79.6	80.6	131.6	128	3.6	20	1
	5	□	MMS1970L-DIN	72.0	101.6	102.6	153.6	150	3.6	20	2
	5	□	MMS1970L-DIN-C	72.0	101.6	102.6	153.6	150	3.6	20	1
	3	□	MMS1970X3DB	62.7	103.6	103.6	164.6	161	3.6	20	1
	5	□	MMS1970X5DB	102.1	143.6	143.6	204.6	201	3.6	20	1
19.8	3	□	MMS1980S-DIN	49.9	79.6	80.6	131.6	128	3.6	20	2
	3	□	MMS1980S-DIN-C	49.9	79.6	80.6	131.6	128	3.6	20	1
	5	□	MMS1980L-DIN	71.9	101.6	102.6	153.6	150	3.6	20	2
	5	□	MMS1980L-DIN-C	71.9	101.6	102.6	153.6	150	3.6	20	1
	3	□	MMS1980X3DB	63.0	103.6	103.6	164.6	161	3.6	20	1
	5	□	MMS1980X5DB	102.6	143.6	143.6	204.6	201	3.6	20	1

DC (mm)	Głębokość otworu (L/D)	DP7020	Numer zamówieniowy	Wymiary (mm)							Typ
				LU	LCF	LH	OAL	LF	PL	DCON	
19.9	3	□	MMS1990S-DIN	49.8	79.6	80.6	131.6	128	3.6	20	2
	3	□	MMS1990S-DIN-C	49.8	79.6	80.6	131.6	128	3.6	20	1
	5	□	MMS1990L-DIN	71.8	101.6	102.6	153.6	150	3.6	20	2
	5	□	MMS1990L-DIN-C	71.8	101.6	102.6	153.6	150	3.6	20	1
	3	□	MMS1990X3DB	63.3	103.6	103.6	164.6	161	3.6	20	1
	5	□	MMS1990X5DB	103.1	143.6	143.6	204.6	201	3.6	20	1
20.0	3	□	MMS2000S-DIN	49.6	79.6	80.6	131.6	128	3.6	20	2
	3	□	MMS2000S-DIN-C	49.6	79.6	80.6	131.6	128	3.6	20	1
	5	□	MMS2000L-DIN	71.6	101.6	102.6	153.6	150	3.6	20	2
	5	□	MMS2000L-DIN-C	71.6	101.6	102.6	153.6	150	3.6	20	1
	3	★	MMS2000X3DB	63.6	103.6	103.6	164.6	161	3.6	20	1
	5	★	MMS2000X5DB	103.6	143.6	143.6	204.6	201	3.6	20	1

WSKAZÓWKI EKSPLOATACYJNE

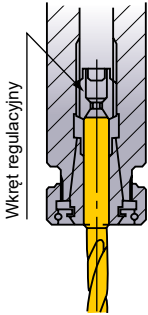
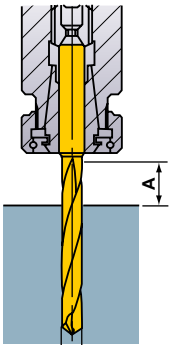
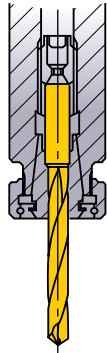
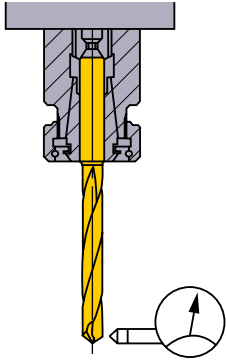
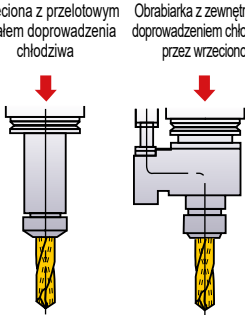
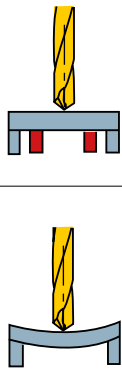
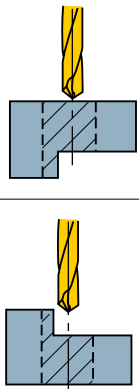
<p>Zamocowanie wiertła</p>  <p>Uchwyt z tuleją wciąganą i łożyskiem oporowym silnie mocuje narzędzie.</p>	<p>Długość wiertła</p>  <p>$A \geq DC \times 1.5$</p>	<p>Montaż wiertła</p>  <p>Nie mocować wiertła za rowek wiórowy.</p>	<p>Tolerancja montażu</p>  <p>Bicie $\leq 0.03\text{mm}$</p>
<p>Typ z przelotowym kanałem doprowadzenia chłodziwa</p>  <p>Wrzeciona z przelotowym kanałem doprowadzenia chłodziwa. Obrabiarka z zewnętrznym doprowadzeniem chłodziwa przez wrzeciono.</p> <p>Ciśnienie chłodziwa wynosi ok. 5 bar—70 bar</p>	<p>Postępowanie z chłodziwem</p> <ol style="list-style-type: none"> 1) Cząstki brudu i kurzu w używanym chłodziwie zatykają kanał doprowadzenia chłodziwa i uniemożliwiają jego skuteczny przepływ. Zalecana jest regularna wymiana chłodziwa. 2) Małe cząstki opiłków zatykają kanał doprowadzenia chłodziwa. Profilaktycznie zawsze używać filtra. Wierząc wiertłem o małej średnicy, używać filtra o małym numerze sita. 	<p>Cienkie przedmioty obrabiane</p>  <p>OK Umieścić przedmiot obrabiany na podpórcie</p> <p>X W razie wystąpienia zginania</p>	<p>Obróbka przerywana</p>  <p>Proces jednozabiegowy OK</p> <p>Ⓛ Podczas wiercenia detalu stopniowanego zmniejszyć posuw.</p> <p>Wymaga wstępnego wiercenia</p> <p>Ⓛ Przed obróbką wystąpienia wiertłem nawiercić frezem palcowym.</p>

ZALECANE PARAMETRY SKRAWANIA

Materiał przedmiotu obrabianego	M							
	Austenityczna stal nierdzewna ($\leq 180\text{HB}$) X5CrNi1810, X5CrNiMo17-12-2				Austenityczna stal nierdzewna (180–280HB) X2CrNiN1810, X2CrNiMoN17-12-2			
Średnica wiertła DC (mm)	Prędkość skrawania (m/min)	Obroty (min^{-1})	Posuw (min.–maks.) (mm/obr.)	Posuw stołu (mm/min)	Prędkość skrawania (m/min)	Obroty (min^{-1})	Posuw (min.–maks.) (mm/obr.)	Posuw stołu (mm/min)
3.2	80	7900	0.13 (0.08–0.18)	1025	60	5900	0.10 (0.05–0.15)	590
4.0	80	6300	0.15 (0.10–0.20)	945	60	4700	0.12 (0.08–0.18)	560
5.0	80	5000	0.15 (0.10–0.20)	750	60	3800	0.12 (0.08–0.18)	455
6.3	80	4000	0.17 (0.12–0.22)	680	60	3000	0.15 (0.10–0.20)	450
8.0	80	3100	0.19 (0.14–0.24)	585	60	2300	0.17 (0.12–0.22)	390
10.0	60	1900	0.20 (0.15–0.25)	380	50	1500	0.18 (0.13–0.23)	270
12.0	60	1500	0.21 (0.16–0.26)	315	50	1300	0.19 (0.14–0.24)	245
16.0	60	1100	0.22 (0.17–0.27)	240	50	900	0.20 (0.15–0.25)	180
20.0	60	900	0.23 (0.18–0.28)	205	50	700	0.21 (0.16–0.26)	145

Materiał przedmiotu obrabianego	M							
	Stal nierdzewna Duplex ($\leq 280\text{HB}$) X3CrNiMoN27-5-2				Stale nierdzewne ferrytyczne i martenzytyczne ($\leq 200\text{HB}$) X10Cr13, X6Cr17			
Średnica wiertła DC (mm)	Prędkość skrawania (m/min)	Obroty (min^{-1})	Posuw (min.–maks.) (mm/obr.)	Posuw stołu (mm/min)	Prędkość skrawania (m/min)	Obroty (min^{-1})	Posuw (min.–maks.) (mm/obr.)	Posuw stołu (mm/min)
3.2	50	4900	0.10 (0.05–0.15)	490	80	7900	0.13 (0.08–0.18)	1025
4.0	50	3900	0.12 (0.08–0.18)	465	80	6300	0.15 (0.10–0.20)	945
5.0	50	3100	0.12 (0.08–0.18)	370	80	5000	0.15 (0.10–0.20)	750
6.3	50	2500	0.15 (0.10–0.20)	375	80	4000	0.17 (0.12–0.22)	680
8.0	50	1900	0.17 (0.12–0.22)	320	80	3100	0.19 (0.14–0.24)	585
10.0	40	1200	0.18 (0.13–0.23)	215	60	1900	0.20 (0.15–0.25)	380
12.0	40	1000	0.19 (0.14–0.24)	190	60	1500	0.21 (0.16–0.26)	315
16.0	40	700	0.20 (0.15–0.25)	140	60	1100	0.22 (0.17–0.27)	240
20.0	40	600	0.21 (0.16–0.26)	125	60	900	0.23 (0.18–0.28)	205

Materiał przedmiotu obrabianego	M							
	Stale nierdzewne ferrytyczne i martenzytyczne ($>200\text{HB}$) X20CrNi17-2, X30Cr13				Stale nierdzewne hartowane ($<450\text{HB}$) X5CrNiCuNb164, X7CrNiAl177, 17-4PH, 17-7PH			
Średnica wiertła DC (mm)	Prędkość skrawania (m/min)	Obroty (min^{-1})	Posuw (min.–maks.) (mm/obr.)	Posuw stołu (mm/min)	Prędkość skrawania (m/min)	Obroty (min^{-1})	Posuw (min.–maks.) (mm/obr.)	Posuw stołu (mm/min)
3.2	60	5900	0.10 (0.05–0.15)	590	50	4900	0.10 (0.05–0.15)	490
4.0	60	4700	0.12 (0.08–0.18)	560	50	3900	0.12 (0.08–0.18)	465
5.0	60	3800	0.12 (0.08–0.18)	455	50	3100	0.12 (0.08–0.18)	370
6.3	60	3000	0.15 (0.10–0.20)	450	50	2500	0.15 (0.10–0.20)	375
8.0	60	2300	0.17 (0.12–0.22)	390	50	1900	0.17 (0.12–0.22)	320
10.0	50	1500	0.18 (0.13–0.23)	270	40	1200	0.18 (0.13–0.23)	215
12.0	50	1300	0.19 (0.14–0.24)	245	40	1000	0.19 (0.14–0.24)	190
16.0	50	900	0.20 (0.15–0.25)	180	40	700	0.20 (0.15–0.25)	140
20.0	50	700	0.21 (0.16–0.26)	145	40	600	0.21 (0.16–0.26)	125

Uwaga 1) Stabilne wiercenie zapewnia podawanie chłodziwa pod wysokim ciśnieniem.

Uwaga 2) Zalecany typ chłodziwa - emulsja wodna.

Uwaga 3) W przypadku chłodziw innych niż wodorocieczalne zmniejszyć obroty o 10%–20%.

TABELA PORÓWNAWCZA OZNACZEŃ STALI NIERDZEWNYCH

Materiał przedmiotu obrabianego		Niemcy		USA	Japonia
		W-no.	DIN	AISI/SAE	JIS
Stal nierdzewna ferrytyczna martenzytyczna	≤200HB	1.4005	X12CrS3	416	SUS416
		1.4006	X10Cr13	410	SUS410
		1.4016	X6Cr17	430	SUS430
		1.4113	X6CrMo17	434	SUS434
		1.4510	X6CrTi17	430Ti	SUS430LX
	>200HB	1.4512	X6CrTi12	409	—
		1.4021	X20Cr13	420	SUS420J1
		1.4057	X20CrNi17-2	431	SUS431
		1.4028	X30Cr13	420	SUS420J2
Stal nierdzewna utwardzana wydzieleniowo	<450HB	1.4125	X10CrMo17	440C	SUS440C
		1.4542	X5CrNiCuNb16 4	630 (17-4PH)	SUS630
		1.4545	—	S15500 (15-5PH)	—
Austenityczna stal nierdzewna	≤200HB	1.4568	X7CrNiAl17 7	631 (17-7PH)	SUS631
		1.4301	X5CrNi18 10	304	SUS304
		1.4303	X5CrNi8-12	305	SUS305
		1.4305	X12CrNiS18-9	303	SUS303
		1.4307	X2CrNi19-11	304L	SUS304L
	>200HB	1.4401	X5CrNiMo17 12 2	316	SUS316
		1.4311	X2CrNiN18 10	304LN	SUS304LN
		1.4404	X2CrNiMo17 12 2	316L	SUS316L
		1.4406	X2CrNiMoN17 12 2	316LN	SUS316LN
		1.4435	X2CrNiMo18 14 3	—	SUS316L
		1.4438	X2CrNiMo18 15 4	317L	SUS317L
		1.4529	X1NiCrMoCuN25 20 7	N08926	—
		1.4541	X6CrNiTi18-10	321	SUS321
		1.4550	X6CrNiNb18-10	347	SUS347
		1.4571	X6CrNiMoTi17 12 2	316Ti	SUS316Ti
Stal austenityczno-ferrytyczna (Duplex)	≤280HB	1.4362	X2CrNiN23 4	—	—
		1.4410	X2CrNiMoN25 7 4	S32750	SCS14A
		1.4460	X3CrNiMoN27 5 2	329	SUS329J1
		1.4462	X2CrNiMoN22 5 3	S31803	SUS329J3L

WIERCENIE (WIERTŁA PEŁNOWĘGLIKOWE)

WĘGLIKI
SPIEKANE

DSAS NEW



P M K N **S** H

Chłodzenie wewnętrzne



Kolor powłoki zależy od kierunku obserwacji. Nie ma to żadnego wpływu na parametry eksploatacyjne wiertła.



DC=3	3<DC≤6	6<DC≤10	10<DC≤12
⁰ _{-0.018}	⁰ _{-0.018}	⁰ _{-0.022}	⁰ _{-0.027}
DCON=6	6<DCON≤10	DCON=12	
⁰ _{-0.018}	⁰ _{-0.009}	⁰ _{-0.011}	

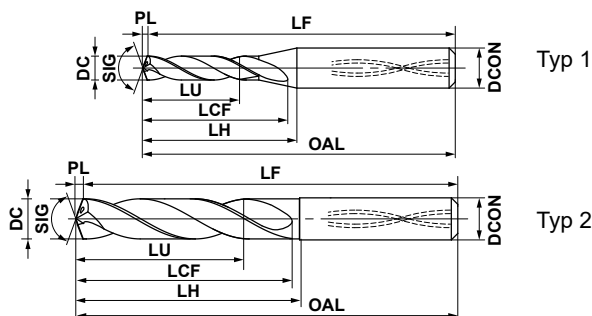

WIERCENIE

M

DC (mm)	Głębokość otworu (L/D)	DP9020	Numer zamówieniowy	Wymiary (mm)							Typ
				LU	LCF	LH	OAL	LF	PL	DCON	
3.00	3	●	DSAS0300X03S060	9.5	21.5	23.5	70.5	70	0.5	6	1
3.10	3	●	DSAS0310X03S060	9.9	21.6	23.6	70.6	70	0.6	6	1
3.18	3	●	DSAS0318X03S060	10.1	21.6	23.6	70.6	70	0.6	6	1
3.20	3	●	DSAS0320X03S060	10.2	21.6	23.6	70.6	70	0.6	6	1
3.26	3	●	DSAS0326X03S060	10.4	21.6	23.6	70.6	70	0.6	6	1
3.30	3	●	DSAS0330X03S060	10.5	21.6	23.6	70.6	70	0.6	6	1
3.40	3	●	DSAS0340X03S060	10.8	21.6	23.6	70.6	70	0.6	6	1
3.50	3	●	DSAS0350X03S060	11.1	21.6	23.6	70.6	70	0.6	6	1
3.57	3	●	DSAS0357X03S060	11.4	22.7	23.7	70.7	70	0.7	6	1
3.60	3	●	DSAS0360X03S060	11.5	22.7	23.7	70.7	70	0.7	6	1
3.70	3	●	DSAS0370X03S060	11.8	22.7	23.7	70.7	70	0.7	6	1
3.80	3	●	DSAS0380X03S060	12.1	22.7	23.7	70.7	70	0.7	6	1
3.90	3	●	DSAS0390X03S060	12.4	22.7	23.7	70.7	70	0.7	6	1
3.97	3	●	DSAS0397X03S060	12.6	22.7	23.7	70.7	70	0.7	6	1
4.00	3	●	DSAS0400X03S060	12.7	22.7	23.7	70.7	70	0.7	6	1
4.10	3	●	DSAS0410X03S060	13.0	24.7	26.7	73.7	73	0.7	6	1
4.20	3	●	DSAS0420X03S060	13.4	24.8	26.8	73.8	73	0.8	6	1
4.30	3	●	DSAS0430X03S060	13.7	24.8	26.8	73.8	73	0.8	6	1
4.37	3	●	DSAS0437X03S060	13.9	24.8	26.8	73.8	73	0.8	6	1
4.40	3	●	DSAS0440X03S060	14.0	24.8	26.8	73.8	73	0.8	6	1
4.50	3	●	DSAS0450X03S060	14.3	24.8	26.8	73.8	73	0.8	6	1
4.60	3	●	DSAS0460X03S060	14.6	25.8	28.8	75.8	75	0.8	6	1
4.70	3	●	DSAS0470X03S060	15.0	25.9	28.9	75.9	75	0.9	6	1
4.76	3	●	DSAS0476X03S060	15.2	25.9	28.9	75.9	75	0.9	6	1
4.80	3	●	DSAS0480X03S060	15.3	25.9	28.9	75.9	75	0.9	6	1
4.86	3	●	DSAS0486X03S060	15.5	25.9	28.9	75.9	75	0.9	6	1
4.90	3	●	DSAS0490X03S060	15.6	25.9	28.9	75.9	75	0.9	6	1
5.00	3	●	DSAS0500X03S060	15.9	28.9	29.9	81.9	81	0.9	6	2
5.10	3	●	DSAS0510X03S060	16.2	28.9	29.9	81.9	81	0.9	6	2
5.16	3	●	DSAS0516X03S060	16.5	29.0	30.0	82.0	81	1.0	6	2
5.20	3	●	DSAS0520X03S060	16.6	29.0	30.0	82.0	81	1.0	6	2
5.30	3	●	DSAS0530X03S060	16.9	29.0	30.0	82.0	81	1.0	6	2

Uwaga 1) Przelotowe kanały chłodziwa wiertła o średnicy do Ø5mm mają przekrój okrągły.

● : Standard magazynowy.

M096

DC (mm)	Głębokość otworu (L/D)	DP9020	Numer zamówieniowy	Wymiary (mm)							Typ
				LU	LCF	LH	OAL	LF	PL	DCON	
5.40	3	●	DSAS0540X03S060	17.2	29.0	30.0	82.0	81	1.0	6	2
5.50	3	●	DSAS0550X03S060	17.5	29.0	30.0	82.0	81	1.0	6	2
5.56	3	●	DSAS0556X03S060	17.8	31.1	31.1	82.1	81	1.1	6	2
5.60	3	●	DSAS0560X03S060	17.9	31.1	31.1	82.1	81	1.1	6	2
5.70	3	●	DSAS0570X03S060	18.2	31.1	31.1	82.1	81	1.1	6	2
5.80	3	●	DSAS0580X03S060	18.5	31.1	31.1	82.1	81	1.1	6	2
5.90	3	●	DSAS0590X03S060	18.8	31.1	31.1	82.1	81	1.1	6	2
5.95	3	●	DSAS0595X03S060	19.0	31.1	31.1	82.1	81	1.1	6	2
6.00	3	●	DSAS0600X03S060	19.1	31.1	31.1	82.1	81	1.1	6	2
6.10	3	●	DSAS0610X03S080	19.5	34.2	37.2	87.2	86	1.2	8	2
6.20	3	●	DSAS0620X03S080	19.8	34.2	37.2	87.2	86	1.2	8	2
6.30	3	●	DSAS0630X03S080	20.1	34.2	37.2	87.2	86	1.2	8	2
6.35	3	●	DSAS0635X03S080	20.3	34.2	37.2	87.2	86	1.2	8	2
6.40	3	●	DSAS0640X03S080	20.4	34.2	37.2	87.2	86	1.2	8	2
6.50	3	●	DSAS0650X03S080	20.7	34.2	37.2	87.2	86	1.2	8	2
6.60	3	●	DSAS0660X03S080	21.1	36.3	38.3	91.3	90	1.3	8	2
6.70	3	●	DSAS0670X03S080	21.4	36.3	38.3	91.3	90	1.3	8	2
6.75	3	●	DSAS0675X03S080	21.6	36.3	38.3	91.3	90	1.3	8	2
6.80	3	●	DSAS0680X03S080	21.7	36.3	38.3	91.3	90	1.3	8	2
6.90	3	●	DSAS0690X03S080	22.0	36.3	38.3	91.3	90	1.3	8	2
6.95	3	●	DSAS0695X03S080	22.2	36.3	38.3	91.3	90	1.3	8	2
7.00	3	●	DSAS0700X03S080	22.3	36.3	38.3	91.3	90	1.3	8	2
7.10	3	●	DSAS0710X03S080	22.7	39.4	40.4	91.4	90	1.4	8	2
7.14	3	●	DSAS0714X03S080	22.8	39.4	40.4	91.4	90	1.4	8	2
7.20	3	●	DSAS0720X03S080	23.0	39.4	40.4	91.4	90	1.4	8	2
7.30	3	●	DSAS0730X03S080	23.3	39.4	40.4	91.4	90	1.4	8	2
7.40	3	●	DSAS0740X03S080	23.6	39.4	40.4	91.4	90	1.4	8	2
7.50	3	●	DSAS0750X03S080	23.9	39.4	40.4	91.4	90	1.4	8	2
7.54	3	●	DSAS0754X03S080	24.0	41.5	41.5	91.5	90	1.5	8	2
7.60	3	●	DSAS0760X03S080	24.3	41.5	41.5	91.5	90	1.5	8	2
7.70	3	●	DSAS0770X03S080	24.6	41.5	41.5	91.5	90	1.5	8	2
7.80	3	●	DSAS0780X03S080	24.9	41.5	41.5	91.5	90	1.5	8	2
7.90	3	●	DSAS0790X03S080	25.2	41.5	41.5	91.5	90	1.5	8	2
7.94	3	●	DSAS0794X03S080	25.3	41.5	41.5	91.5	90	1.5	8	2
8.00	3	●	DSAS0800X03S080	25.5	41.5	41.5	91.5	90	1.5	8	2
8.10	3	●	DSAS0810X03S100	25.8	44.5	47.5	97.5	96	1.5	10	2
8.20	3	●	DSAS0820X03S100	26.1	44.5	47.5	97.5	96	1.5	10	2
8.30	3	●	DSAS0830X03S100	26.4	44.5	47.5	97.5	96	1.5	10	2
8.33	3	●	DSAS0833X03S100	26.5	44.5	47.5	97.5	96	1.5	10	2
8.40	3	●	DSAS0840X03S100	26.7	44.5	47.5	97.5	96	1.5	10	2
8.50	3	●	DSAS0850X03S100	27.0	44.5	47.5	97.5	96	1.5	10	2
8.60	3	●	DSAS0860X03S100	27.4	46.6	48.6	102.6	101	1.6	10	2
8.70	3	●	DSAS0870X03S100	27.7	46.6	48.6	102.6	101	1.6	10	2
8.73	3	●	DSAS0873X03S100	27.8	46.6	48.6	102.6	101	1.6	10	2
8.80	3	●	DSAS0880X03S100	28.0	46.6	48.6	102.6	101	1.6	10	2
8.90	3	●	DSAS0890X03S100	28.3	46.6	48.6	102.6	101	1.6	10	2
9.00	3	●	DSAS0900X03S100	28.6	46.6	48.6	102.6	101	1.6	10	2
9.10	3	●	DSAS0910X03S100	29.1	49.8	50.8	102.8	101	1.8	10	2
9.20	3	●	DSAS0920X03S100	29.4	49.8	50.8	102.8	101	1.8	10	2
9.30	3	●	DSAS0930X03S100	29.7	49.8	50.8	102.8	101	1.8	10	2
9.40	3	●	DSAS0940X03S100	30.0	49.8	50.8	102.8	101	1.8	10	2
9.50	3	●	DSAS0950X03S100	30.3	49.8	50.8	102.8	101	1.8	10	2
9.53	3	●	DSAS0953X03S100	30.4	49.8	50.8	102.8	101	1.8	10	2
9.60	3	●	DSAS0960X03S100	30.6	49.8	50.8	102.8	101	1.8	10	2
9.70	3	●	DSAS0970X03S100	30.9	49.8	50.8	102.8	101	1.8	10	2
9.80	3	●	DSAS0980X03S100	31.2	51.8	51.8	102.8	101	1.8	10	2
9.90	3	●	DSAS0990X03S100	31.5	51.8	51.8	102.8	101	1.8	10	2
9.92	3	●	DSAS0992X03S100	31.6	51.8	51.8	102.8	101	1.8	10	2

WIERCENIE (WIERTŁA PEŁNOWĘGLIKOWE)

DSAS NEW

WĘGLIKI
SPIEKANE

M

WIERCENIE

DC (mm)	Głębokość otworu (L/D)	DP9020	Numer zamówieniowy	Wymiary (mm)							Typ
				LU	LCF	LH	OAL	LF	PL	DCON	
10.00	3	●	DSAS1000X03S100	31.8	51.8	51.8	102.8	101	1.8	10	2
10.10	3	●	DSAS1010X03S120	32.2	54.9	57.9	112.9	111	1.9	12	2
10.20	3	●	DSAS1020X03S120	32.5	54.9	57.9	112.9	111	1.9	12	2
10.30	3	●	DSAS1030X03S120	32.8	54.9	57.9	112.9	111	1.9	12	2
10.32	3	●	DSAS1032X03S120	32.9	54.9	57.9	112.9	111	1.9	12	2
10.40	3	●	DSAS1040X03S120	33.1	54.9	57.9	112.9	111	1.9	12	2
10.50	3	●	DSAS1050X03S120	33.4	54.9	57.9	112.9	111	1.9	12	2
10.60	3	●	DSAS1060X03S120	33.7	54.9	57.9	112.9	111	1.9	12	2
10.70	3	●	DSAS1070X03S120	34.0	54.9	57.9	112.9	111	1.9	12	2
10.72	3	●	DSAS1072X03S120	34.2	57.0	59.0	118.0	116	2.0	12	2
10.80	3	●	DSAS1080X03S120	34.4	57.0	59.0	118.0	116	2.0	12	2
10.90	3	●	DSAS1090X03S120	34.7	57.0	59.0	118.0	116	2.0	12	2
11.00	3	●	DSAS1100X03S120	35.0	57.0	59.0	118.0	116	2.0	12	2
11.10	3	●	DSAS1110X03S120	35.4	60.1	61.1	118.1	116	2.1	12	2
11.11	3	●	DSAS1111X03S120	35.4	60.1	61.1	118.1	116	2.1	12	2
11.20	3	●	DSAS1120X03S120	35.7	60.1	61.1	118.1	116	2.1	12	2
11.30	3	●	DSAS1130X03S120	36.0	60.1	61.1	118.1	116	2.1	12	2
11.40	3	●	DSAS1140X03S120	36.3	60.1	61.1	118.1	116	2.1	12	2
11.50	3	●	DSAS1150X03S120	36.6	60.1	61.1	118.1	116	2.1	12	2
11.51	3	●	DSAS1151X03S120	36.7	62.2	62.2	118.2	116	2.2	12	2
11.60	3	●	DSAS1160X03S120	37.0	62.2	62.2	118.2	116	2.2	12	2
11.70	3	●	DSAS1170X03S120	37.3	62.2	62.2	118.2	116	2.2	12	2
11.80	3	●	DSAS1180X03S120	37.6	62.2	62.2	118.2	116	2.2	12	2
11.90	3	●	DSAS1190X03S120	37.9	62.2	62.2	118.2	116	2.2	12	2
12.00	3	●	DSAS1200X03S120	38.2	62.2	62.2	118.2	116	2.2	12	2

● : Standard magazynowy.

ZALECANE PARAMETRY SKRAWANIA

Materiał przedmiotu obrabianego		S			
		Stopy żaroodporne Inconel718 itp.		Stopy tytanu Ti-6Al-4V itp.	
Średnica wiertła DC (mm)	L/D	Obroty (min ⁻¹)	Posuw (min. – maks.) (mm/obr.)	Obroty (min ⁻¹)	Posuw (min. – maks.) (mm/obr.)
3	≤ 3	1000	0.06 (0.04–0.10)	4200	0.08 (0.06–0.12)
4	≤ 3	790	0.06 (0.04–0.10)	3100	0.10 (0.08–0.16)
5	≤ 3	760	0.08 (0.06–0.12)	2500	0.12 (0.08–0.20)
6	≤ 3	790	0.10 (0.08–0.15)	2100	0.14 (0.10–0.20)
8	≤ 3	590	0.10 (0.08–0.15)	1600	0.18 (0.15–0.25)
10	≤ 3	570	0.10 (0.08–0.15)	1300	0.22 (0.18–0.28)
12	≤ 3	530	0.12 (0.08–0.15)	1100	0.24 (0.20–0.30)

Uwaga 1) Stabilne wiercenie zapewnia podawanie chłodziwa pod wysokim ciśnieniem przez wrzeciono.

Uwaga 2) Zalecany typ chłodziwa: emulsja wodna.

Uwaga 3) W przypadku chłodziw innych niż wodorozcieńczalne zmniejszyć obroty o 10-20%.

Uwaga 4) Podczas wiercenia z zewnętrznym podawaniem chłodziwa, zaleca się posuw stopniowy z wycofaniem wiertła co DC x 0.5, gdyż ułatwia to łamanie wióra.

WIERCENIE (WIERTŁA PEŁNOWĘGLIKOWE)

MNS



WĘGLIKI
SPIEKANE

P M K **N** S H

Chłodzenie wewnętrzne



	DC=3	3<DC≤6	6<DC≤10	10<DC≤18	18<DC≤20
Typ DIN	+0.016 +0.004	+0.016 +0.004	+0.021 +0.006	+0.025 +0.007	+0.029 +0.008
Inne	0 -0.014	0 -0.018	0 -0.022	0 -0.027	0 -0.031
h6	0 -0.006	0 -0.008	0 -0.009	0 -0.011	0 -0.013

- Wiertła o średnicach do 4.5mm posiadają 2 kanały doprowadzenia chłodziwa.
- Wiertła o średnicach do 4.6 mm mają 4 kanały doprowadzenia chłodziwa.

● Typ 1 MNS----DIN-C, MNS-C, MNS----LB, MNS----DB (Typ z chwytym walcowym)

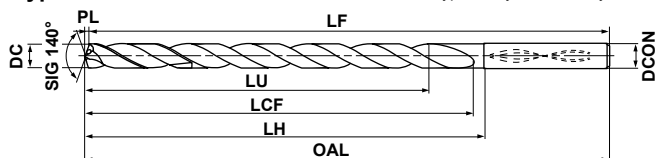

● Typ 2 MNS----S/L-DIN (Chwyt Whistle-Notch)

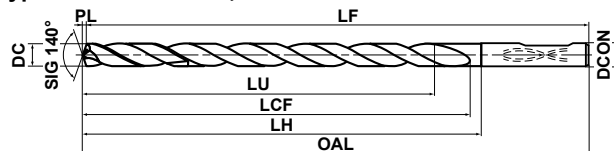

● Typ 3 MNS----DIN-C, MNS-C, MNS----LB, MNS----DB (Typ z chwytym walcowym)

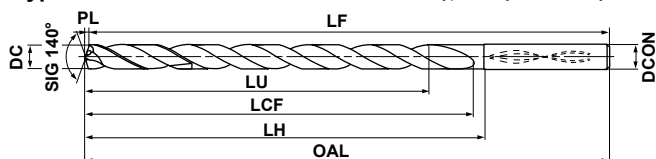

● Typ 4 MNS----S/L-DIN (Chwyt Whistle-Notch)

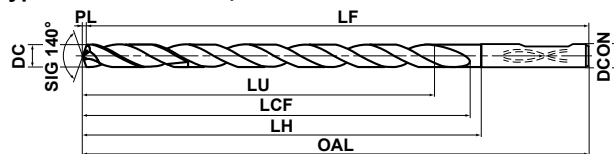

- Wiertła MNS można stosować z oprawkami termicznymi.

DC (mm)	Głębokość otworu (L/D)	TF15	Numer zamówieniowy	Wymiary (mm)							Typ
				LU	LCF	LH	OAL	LF	PL	DCON	
3.0	3	□	MNS0300S-DIN	15.0	19.5	24.5	61.5	61	0.5	6	2
	3	□	MNS0300S-DIN-C	15.0	19.5	24.5	61.5	61	0.5	6	1
	5	□	MNS0300L-DIN	23.0	27.5	28.5	65.5	65	0.5	6	2
	5	●	MNS0300L-DIN-C	23.0	27.5	28.5	65.5	65	0.5	6	1
	8	□	MNS0300-L8C	24.5	33.5	36.5	73.5	73	0.5	6	1
	10	□	MNS0300-L10C	30.5	39.5	42.5	79.5	79	0.5	6	1
	12	●	MNS0300-L12C	36.5	45.5	48.5	85.5	85	0.5	6	1
	15	□	MNS0300-L15C	45.5	54.5	57.5	94.5	94	0.5	6	1
	20	●	MNS0300-L20C	60.5	69.5	72.5	109.5	109	0.5	6	1
	25	□	MNS0300-L25C	75.5	84.5	87.5	124.5	124	0.5	6	1
3.1	30	●	MNS0300-L30C	90.5	99.5	102.5	139.5	139	0.5	6	1
	5	★	MNS0300LB	15.5	33.5	33.5	81.5	81	0.5	3	1
	10	★	MNS0300X10DB	30.5	39.5	42.5	90.5	90	0.5	3	1
	20	★	MNS0300X20DB	60.5	69.5	72.5	120.5	120	0.5	3	1
	30	★	MNS0300X30DB	90.5	99.5	102.5	150.5	150	0.5	3	1
	3	□	MNS0310S-DIN	14.9	19.6	24.6	61.6	61	0.6	6	2
	3	□	MNS0310S-DIN-C	14.9	19.6	24.6	61.6	61	0.6	6	1
	5	□	MNS0310L-DIN	22.9	27.6	28.6	65.6	65	0.6	6	2
	5	□	MNS0310L-DIN-C	22.9	27.6	28.6	65.6	65	0.6	6	1
	8	□	MNS0310-L8C	25.4	39.6	42.6	79.6	79	0.6	6	1
10	□	MNS0310-L10C	31.6	46.6	49.6	86.6	86	0.6	6	1	
12	□	MNS0310-L12C	37.8	53.6	56.6	93.6	93	0.6	6	1	
15	□	MNS0310-L15C	47.1	63.6	66.6	103.6	103	0.6	6	1	
20	□	MNS0310-L20C	62.6	81.6	84.6	121.6	121	0.6	6	1	
25	□	MNS0310-L25C	78.1	98.6	101.6	138.6	138	0.6	6	1	
30	□	MNS0310-L30C	93.6	116.6	119.6	156.6	156	0.6	6	1	
5	★	MNS0310LB	16.1	39.6	39.6	87.6	87	0.6	4	1	
10	□	MNS0310X10DB	31.6	46.6	49.6	97.6	97	0.6	4	1	
20	□	MNS0310X20DB	62.6	81.6	84.6	132.6	132	0.6	4	1	
30	□	MNS0310X30DB	93.6	116.6	119.6	167.6	167	0.6	4	1	

DC (mm)	Głębokość otworu (L/D)	TF15	Numer zamówieniowy	Wymiary (mm)							Typ
				LU	LCF	LH	OAL	LF	PL	DCON	
3.2	3	□	MNS0320S-DIN	14.8	19.6	24.6	61.6	61	0.6	6	2
	3	□	MNS0320S-DIN-C	14.8	19.6	24.6	61.6	61	0.6	6	1
	5	□	MNS0320L-DIN	22.8	27.6	28.6	65.6	65	0.6	6	2
	5	●	MNS0320L-DIN-C	22.8	27.6	28.6	65.6	65	0.6	6	1
	8	□	MNS0320-L8C	26.2	39.6	42.6	79.6	79	0.6	6	1
	10	□	MNS0320-L10C	32.6	46.6	49.6	86.6	86	0.6	6	1
	12	●	MNS0320-L12C	39.0	53.6	56.6	93.6	93	0.6	6	1
	15	□	MNS0320-L15C	48.6	63.6	66.6	103.6	103	0.6	6	1
	20	●	MNS0320-L20C	64.6	81.6	84.6	121.6	121	0.6	6	1
	25	□	MNS0320-L25C	80.6	98.6	101.6	138.6	138	0.6	6	1
3.3	30	●	MNS0320-L30C	96.6	116.6	119.6	156.6	156	0.6	6	1
	5	★	MNS0320LB	16.6	39.6	39.6	87.6	87	0.6	4	1
	10	★	MNS0320X10DB	32.6	46.6	49.6	97.6	97	0.6	4	1
	20	★	MNS0320X20DB	64.6	81.6	84.6	132.6	132	0.6	4	1
	30	★	MNS0320X30DB	96.6	116.6	119.6	167.6	167	0.6	4	1
	3	□	MNS0330S-DIN	14.7	19.6	24.6	61.6	61	0.6	6	1
	3	□	MNS0330S-DIN-C	14.7	19.6	24.6	61.6	61	0.6	6	1
	5	□	MNS0330L-DIN	22.7	27.6	28.6	65.6	65	0.6	6	2
	5	●	MNS0330L-DIN-C	22.7	27.6	28.6	65.6	65	0.6	6	1
	8	□	MNS0330-L8C	27.0	39.6	42.6	79.6	79	0.6	6	1
10	□	MNS0330-L10C	33.6	46.6	49.6	86.6	86	0.6	6	1	
12	●	MNS0330-L12C	40.2	53.6	56.6	93.6	93	0.6	6	1	
15	□	MNS0330-L15C	50.1	63.6	66.6	103.6	103	0.6	6	1	
20	●	MNS0330-L20C	66.6	81.6	84.6	121.6	121	0.6	6	1	
25	□	MNS0330-L25C	83.1	98.6	101.6	138.6	138	0.6	6	1	
30	●	MNS0330-L30C	99.6	116.6	119.6	156.6	156	0.6	6	1	
5	★	MNS0330LB	17.1	39.6	39.6	87.6	87	0.6	4	1	
10	□	MNS0330X10DB	33.6	46.6	49.6	97.6	97	0.6	4	1	
20	□	MNS0330X20DB	66.6	81.6	84.6	132.6	132	0.6	4	1	
30	□	MNS0330X30DB	99.6	116.6	119.6	167.6	167	0.6	4	1	

Uwaga 1) Gdy geometria wiertła nie odpowiada wartościom podanym w tabeli (np. inna średnica i długość wiertła), prosimy o skontaktowanie się z naszą firmą.

● : Standard magazynowy. ★ : Na specjalne zamówienie z magazynu w Japonii.

□ : Niestandardowy, produkowany na specjalne zamówienie.

DC (mm)	Głębokość otworu (L/D)	TF15	Numer zamówieniowy	Wymiary (mm)							Typ
				LU	LCF	LH	OAL	LF	PL	DCON	
3.4	3	□	MNS0340S-DIN	14.5	19.6	24.6	61.6	61	0.6	6	2
	3	□	MNS0340S-DIN-C	14.5	19.6	24.6	61.6	61	0.6	6	1
	5	□	MNS0340L-DIN	22.5	27.6	28.6	65.6	65	0.6	6	2
	5	□	MNS0340L-DIN-C	22.5	27.6	28.6	65.6	65	0.6	6	1
	8	□	MNS0340-L8C	27.8	39.6	42.6	79.6	79	0.6	6	1
	10	□	MNS0340-L10C	34.6	46.6	49.6	86.6	86	0.6	6	1
	12	□	MNS0340-L12C	41.4	53.6	56.6	93.6	93	0.6	6	1
	15	□	MNS0340-L15C	51.6	63.6	66.6	103.6	103	0.6	6	1
	20	□	MNS0340-L20C	68.6	81.6	84.6	121.6	121	0.6	6	1
	25	□	MNS0340-L25C	85.6	98.6	101.6	138.6	138	0.6	6	1
	30	□	MNS0340-L30C	102.6	116.6	119.6	156.6	156	0.6	6	1
	5	★	MNS0340LB	17.6	39.6	39.6	87.6	87	0.6	4	1
	10	★	MNS0340X10DB	34.6	46.6	49.6	97.6	97	0.6	4	1
	20	★	MNS0340X20DB	68.6	81.6	84.6	132.6	132	0.6	4	1
	30	★	MNS0340X30DB	102.6	116.6	119.6	167.6	167	0.6	4	1
3.5	3	□	MNS0350S-DIN	14.4	19.6	24.6	61.6	61	0.6	6	2
	3	□	MNS0350S-DIN-C	14.4	19.6	24.6	61.6	61	0.6	6	1
	5	□	MNS0350L-DIN	22.4	27.6	28.6	65.6	65	0.6	6	2
	5	●	MNS0350L-DIN-C	22.4	27.6	28.6	65.6	65	0.6	6	1
	8	□	MNS0350-L8C	28.6	39.6	42.6	79.6	79	0.6	6	1
	10	□	MNS0350-L10C	35.6	46.6	49.6	86.6	86	0.6	6	1
	12	●	MNS0350-L12C	42.6	53.6	56.6	93.6	93	0.6	6	1
	15	□	MNS0350-L15C	53.1	63.6	66.6	103.6	103	0.6	6	1
	20	●	MNS0350-L20C	70.6	81.6	84.6	121.6	121	0.6	6	1
	25	□	MNS0350-L25C	88.1	98.6	101.6	138.6	138	0.6	6	1
	30	●	MNS0350-L30C	105.6	116.6	119.6	156.6	156	0.6	6	1
	5	★	MNS0350LB	18.1	39.6	39.6	87.6	87	0.6	4	1
	10	□	MNS0350X10DB	35.6	46.6	49.6	97.6	97	0.6	4	1
	20	□	MNS0350X20DB	70.6	81.6	84.6	132.6	132	0.6	4	1
	30	□	MNS0350X30DB	105.6	116.6	119.6	167.6	167	0.6	4	1
3.6	3	□	MNS0360S-DIN	14.3	19.7	24.7	61.7	61	0.7	6	2
	3	□	MNS0360S-DIN-C	14.3	19.7	24.7	61.7	61	0.7	6	1
	5	□	MNS0360L-DIN	22.3	27.7	28.7	65.7	65	0.7	6	2
	5	□	MNS0360L-DIN-C	22.3	27.7	28.7	65.7	65	0.7	6	1
	8	□	MNS0360-L8C	29.5	44.7	47.7	84.7	84	0.7	6	1
	10	□	MNS0360-L10C	36.7	52.7	55.7	92.7	92	0.7	6	1
	12	□	MNS0360-L12C	43.9	60.7	63.7	100.7	100	0.7	6	1
	15	□	MNS0360-L15C	54.7	72.7	75.7	112.7	112	0.7	6	1
	20	□	MNS0360-L20C	72.7	92.7	95.7	132.7	132	0.7	6	1
	25	□	MNS0360-L25C	90.7	112.7	115.7	152.7	152	0.7	6	1
	30	□	MNS0360-L30C	108.7	132.7	135.7	172.7	172	0.7	6	1
	5	★	MNS0360LB	18.7	44.7	44.7	92.7	92	0.7	4	1
	10	★	MNS0360X10DB	36.7	52.7	55.7	103.7	103	0.7	4	1
	20	★	MNS0360X20DB	72.7	92.7	95.7	143.7	143	0.7	4	1
	30	★	MNS0360X30DB	108.7	132.7	135.7	183.7	183	0.7	4	1

DC (mm)	Głębokość otworu (L/D)	TF15	Numer zamówieniowy	Wymiary (mm)							Typ
				LU	LCF	LH	OAL	LF	PL	DCON	
3.7	3	□	MNS0370S-DIN	14.1	19.7	24.7	61.7	61	0.7	6	2
	3	□	MNS0370S-DIN-C	14.1	19.7	24.7	61.7	61	0.7	6	1
	5	□	MNS0370L-DIN	22.1	27.7	28.7	65.7	65	0.7	6	2
	5	□	MNS0370L-DIN-C	22.1	27.7	28.7	65.7	65	0.7	6	1
	8	□	MNS0370-L8C	30.3	44.7	47.7	84.7	84	0.7	6	1
	10	□	MNS0370-L10C	37.7	52.7	55.7	92.7	92	0.7	6	1
	12	□	MNS0370-L12C	45.1	60.7	63.7	100.7	100	0.7	6	1
	15	□	MNS0370-L15C	56.2	72.7	75.7	112.7	112	0.7	6	1
	20	□	MNS0370-L20C	74.7	92.7	95.7	132.7	132	0.7	6	1
	25	□	MNS0370-L25C	93.2	112.7	115.7	152.7	152	0.7	6	1
	30	□	MNS0370-L30C	111.7	132.7	135.7	172.7	172	0.7	6	1
	5	★	MNS0370LB	19.2	44.7	44.7	92.7	92	0.7	4	1
	10	□	MNS0370X10DB	37.7	52.7	55.7	103.7	103	0.7	4	1
	20	□	MNS0370X20DB	74.7	92.7	95.7	143.7	143	0.7	4	1
	30	□	MNS0370X30DB	111.7	132.7	135.7	183.7	183	0.7	4	1
3.8	3	□	MNS0380S-DIN	18.0	23.7	28.7	65.7	65	0.7	6	2
	3	□	MNS0380S-DIN-C	18.0	23.7	28.7	65.7	65	0.7	6	1
	5	□	MNS0380L-DIN	30.0	35.7	36.7	73.7	73	0.7	6	2
	5	□	MNS0380L-DIN-C	30.0	35.7	36.7	73.7	73	0.7	6	1
	8	□	MNS0380-L8C	31.1	44.7	47.7	84.7	84	0.7	6	1
	10	□	MNS0380-L10C	38.7	52.7	55.7	92.7	92	0.7	6	1
	12	□	MNS0380-L12C	46.3	60.7	63.7	100.7	100	0.7	6	1
	15	□	MNS0380-L15C	57.7	72.7	75.7	112.7	112	0.7	6	1
	20	□	MNS0380-L20C	76.7	92.7	95.7	132.7	132	0.7	6	1
	25	□	MNS0380-L25C	95.7	112.7	115.7	152.7	152	0.7	6	1
	30	□	MNS0380-L30C	114.7	132.7	135.7	172.7	172	0.7	6	1
	5	★	MNS0380LB	19.7	44.7	44.7	92.7	92	0.7	4	1
	10	□	MNS0380X10DB	38.7	52.7	55.7	103.7	103	0.7	4	1
	20	□	MNS0380X20DB	76.7	92.7	95.7	143.7	143	0.7	4	1
	30	□	MNS0380X30DB	114.7	132.7	135.7	183.7	183	0.7	4	1
3.9	3	□	MNS0390S-DIN	17.9	23.7	28.7	65.7	65	0.7	6	2
	3	□	MNS0390S-DIN-C	17.9	23.7	28.7	65.7	65	0.7	6	1
	5	□	MNS0390L-DIN	29.9	35.7	36.7	73.7	73	0.7	6	2
	5	□	MNS0390L-DIN-C	29.9	35.7	36.7	73.7	73	0.7	6	1
	8	□	MNS0390-L8C	31.9	44.7	47.7	84.7	84	0.7	6	1
	10	□	MNS0390-L10C	39.7	52.7	55.7	92.7	92	0.7	6	1
	12	□	MNS0390-L12C	47.5	60.7	63.7	100.7	100	0.7	6	1
	15	□	MNS0390-L15C	59.2	72.7	75.7	112.7	112	0.7	6	1
	20	□	MNS0390-L20C	78.7	92.7	95.7	132.7	132	0.7	6	1
	25	□	MNS0390-L25C	98.2	112.7	115.7	152.7	152	0.7	6	1
	30	□	MNS0390-L30C	117.7	132.7	135.7	172.7	172	0.7	6	1
	5	★	MNS0390LB	20.2	44.7	44.7	92.7	92	0.7	4	1
	10	★	MNS0390X10DB	39.7	52.7	55.7	103.7	103	0.7	4	1
	20	★	MNS0390X20DB	78.7	92.7	95.7	143.7	143	0.7	4	1
	30	★	MNS0390X30DB	117.7	132.7	135.7	183.7	183	0.7	4	1

WIERCENIE (WIERTŁA PEŁNOWĘGLIKOWE)

MNS

WĘGLIKI
SPIEKANE

M

WIERCENIE

DC (mm)	Głębokość otworu (L/D)	TF15	Numer zamówieniowy	Wymiary (mm)							Typ
				LU	LCF	LH	OAL	LF	PL	DCON	
4.0	3	□	MNS0400S-DIN	17.7	23.7	28.7	65.7	65	0.7	6	2
	3	□	MNS0400S-DIN-C	17.7	23.7	28.7	65.7	65	0.7	6	1
	5	□	MNS0400L-DIN	29.7	35.7	36.7	73.7	73	0.7	6	2
	5	●	MNS0400L-DIN-C	29.7	35.7	36.7	73.7	73	0.7	6	1
	8	□	MNS0400-L8C	32.7	44.7	47.7	84.7	84	0.7	6	1
	10	□	MNS0400-L10C	40.7	52.7	55.7	92.7	92	0.7	6	1
	12	●	MNS0400-L12C	48.7	60.7	63.7	100.7	100	0.7	6	1
	15	□	MNS0400-L15C	60.7	72.7	75.7	112.7	112	0.7	6	1
	20	●	MNS0400-L20C	80.7	92.7	95.7	132.7	132	0.7	6	1
	25	●	MNS0400-L25C	100.7	112.7	115.7	152.7	152	0.7	6	1
	30	●	MNS0400-L30C	120.7	132.7	135.7	172.7	172	0.7	6	1
	5	★	MNS0400LB	20.7	44.7	44.7	92.7	92	0.7	4	1
	10	★	MNS0400X10DB	40.7	52.7	55.7	103.7	103	0.7	4	1
20	★	MNS0400X20DB	80.7	92.7	95.7	143.7	143	0.7	4	1	
30	★	MNS0400X30DB	120.7	132.7	135.7	183.7	183	0.7	4	1	
4.1	3	□	MNS0410S-DIN	17.6	23.7	28.7	65.7	65	0.7	6	2
	3	□	MNS0410S-DIN-C	17.6	23.7	28.7	65.7	65	0.7	6	1
	5	□	MNS0410L-DIN	29.6	35.7	36.7	73.7	73	0.7	6	2
	5	□	MNS0410L-DIN-C	29.6	35.7	36.7	73.7	73	0.7	6	1
	8	□	MNS0410-L8C	33.5	50.7	53.7	90.7	90	0.7	6	1
	10	□	MNS0410-L10C	41.7	59.7	62.7	99.7	99	0.7	6	1
	12	□	MNS0410-L12C	49.9	68.7	71.7	108.7	108	0.7	6	1
	15	□	MNS0410-L15C	62.2	81.7	84.7	121.7	121	0.7	6	1
	20	□	MNS0410-L20C	82.7	104.7	107.7	144.7	144	0.7	6	1
	25	□	MNS0410-L25C	103.2	126.7	129.7	166.7	166	0.7	6	1
	30	□	MNS0410-L30C	123.7	149.7	152.7	189.7	189	0.7	6	1
	5	★	MNS0410LB	21.2	50.7	50.7	100.7	100	0.7	5	1
	10	□	MNS0410X10DB	41.7	59.7	62.7	112.7	112	0.7	5	1
20	□	MNS0410X20DB	82.7	104.7	107.7	157.7	157	0.7	5	1	
30	□	MNS0410X30DB	123.7	149.7	152.7	202.7	202	0.7	5	1	
4.2	3	□	MNS0420S-DIN	17.5	23.8	28.8	65.8	65	0.8	6	2
	3	□	MNS0420S-DIN-C	17.5	23.8	28.8	65.8	65	0.8	6	1
	5	□	MNS0420L-DIN	29.5	35.8	36.8	73.8	73	0.8	6	2
	5	●	MNS0420L-DIN-C	29.5	35.8	36.8	73.8	73	0.8	6	1
	8	□	MNS0420-L8C	34.4	50.8	53.8	90.8	90	0.8	6	1
	10	□	MNS0420-L10C	42.8	59.8	62.8	99.8	99	0.8	6	1
	12	●	MNS0420-L12C	51.2	68.8	71.8	108.8	108	0.8	6	1
	15	□	MNS0420-L15C	63.8	81.8	84.8	121.8	121	0.8	6	1
	20	●	MNS0420-L20C	84.8	104.8	107.8	144.8	144	0.8	6	1
	25	□	MNS0420-L25C	105.8	126.8	129.8	166.8	166	0.8	6	1
	30	●	MNS0420-L30C	126.8	149.8	152.8	189.8	189	0.8	6	1
	5	★	MNS0420LB	21.8	50.8	50.8	100.8	100	0.8	5	1
	10	□	MNS0420X10DB	42.8	59.8	62.8	112.8	112	0.8	5	1
20	□	MNS0420X20DB	84.8	104.8	107.8	157.8	157	0.8	5	1	
30	□	MNS0420X30DB	126.8	149.8	152.8	202.8	202	0.8	5	1	

DC (mm)	Głębokość otworu (L/D)	TF15	Numer zamówieniowy	Wymiary (mm)							Typ
				LU	LCF	LH	OAL	LF	PL	DCON	
4.3	3	□	MNS0430S-DIN	17.3	23.8	28.8	65.8	65	0.8	6	2
	3	□	MNS0430S-DIN-C	17.3	23.8	28.8	65.8	65	0.8	6	1
	5	□	MNS0430L-DIN	29.3	35.8	36.8	73.8	73	0.8	6	2
	5	□	MNS0430L-DIN-C	29.3	35.8	36.8	73.8	73	0.8	6	1
	8	□	MNS0430-L8C	35.2	50.8	53.8	90.8	90	0.8	6	1
	10	□	MNS0430-L10C	43.8	59.8	62.8	99.8	99	0.8	6	1
	12	□	MNS0430-L12C	52.4	68.8	71.8	108.8	108	0.8	6	1
	15	□	MNS0430-L15C	65.3	81.8	84.8	121.8	121	0.8	6	1
	20	□	MNS0430-L20C	86.8	104.8	107.8	144.8	144	0.8	6	1
	25	□	MNS0430-L25C	108.3	126.8	129.8	166.8	166	0.8	6	1
	30	□	MNS0430-L30C	129.8	149.8	152.8	189.8	189	0.8	6	1
	5	★	MNS0430LB	22.3	50.8	50.8	100.8	100	0.8	5	1
	10	□	MNS0430X10DB	43.8	59.8	62.8	112.8	112	0.8	5	1
20	□	MNS0430X20DB	86.8	104.8	107.8	157.8	157	0.8	5	1	
30	□	MNS0430X30DB	129.8	149.8	152.8	202.8	202	0.8	5	1	
4.4	3	□	MNS0440S-DIN	17.2	23.8	28.8	65.8	65	0.8	6	2
	3	□	MNS0440S-DIN-C	17.2	23.8	28.8	65.8	65	0.8	6	1
	5	□	MNS0440L-DIN	29.2	35.8	36.8	73.8	73	0.8	6	2
	5	□	MNS0440L-DIN-C	29.2	35.8	36.8	73.8	73	0.8	6	1
	8	□	MNS0440-L8C	36.0	50.8	53.8	90.8	90	0.8	6	1
	10	□	MNS0440-L10C	44.8	59.8	62.8	99.8	99	0.8	6	1
	12	□	MNS0440-L12C	53.6	68.8	71.8	108.8	108	0.8	6	1
	15	□	MNS0440-L15C	66.8	81.8	84.8	121.8	121	0.8	6	1
	20	□	MNS0440-L20C	88.8	104.8	107.8	144.8	144	0.8	6	1
	25	□	MNS0440-L25C	110.8	126.8	129.8	166.8	166	0.8	6	1
	30	□	MNS0440-L30C	132.8	149.8	152.8	189.8	189	0.8	6	1
	5	★	MNS0440LB	22.8	50.8	50.8	100.8	100	0.8	5	1
	10	□	MNS0440X10DB	44.8	59.8	62.8	112.8	112	0.8	5	1
20	□	MNS0440X20DB	88.8	104.8	107.8	157.8	157	0.8	5	1	
30	□	MNS0440X30DB	132.8	149.8	152.8	202.8	202	0.8	5	1	
4.5	3	□	MNS0450S-DIN	17.1	23.8	28.8	65.8	65	0.8	6	2
	3	□	MNS0450S-DIN-C	17.1	23.8	28.8	65.8	65	0.8	6	1
	5	□	MNS0450L-DIN	29.1	35.8	36.8	73.8	73	0.8	6	2
	5	●	MNS0450L-DIN-C	29.1	35.8	36.8	73.8	73	0.8	6	1
	8	□	MNS0450-L8C	36.8	50.8	53.8	90.8	90	0.8	6	1
	10	□	MNS0450-L10C	45.8	59.8	62.8	99.8	99	0.8	6	1
	12	●	MNS0450-L12C	54.8	68.8	71.8	108.8	108	0.8	6	1
	15	□	MNS0450-L15C	68.3	81.8	84.8	121.8	121	0.8	6	1
	20	●	MNS0450-L20C	90.8	104.8	107.8	144.8	144	0.8	6	1
	25	□	MNS0450-L25C	113.3	126.8	129.8	166.8	166	0.8	6	1
	30	●	MNS0450-L30C	135.8	149.8	152.8	189.8	189	0.8	6	1
	5	★	MNS0450LB	23.3	50.8	50.8	100.8	100	0.8	5	1
	10	□	MNS0450X10DB	45.8	59.8	62.8	112.8	112	0.8	5	1
20	□	MNS0450X20DB	90.8	104.8	107.8	157.8	157	0.8	5	1	
30	□	MNS0450X30DB	135.8	149.8	152.8	202.8	202	0.8	5	1	

Uwaga 1) Gdy geometria wiertła nie odpowiada wartościom podanym w tabeli (np. inna średnica i długość wiertła), prosimy o skontaktowanie się z naszą firmą.

● : Standard magazynowy. ★ : Na specjalne zamówienie z magazynu w Japonii.

□ : Niestandardowy, produkowany na specjalne zamówienie.

DC (mm)	Głębokość otworu (L/D)	TF15	Numer zamówieniowy	Wymiary (mm)							Typ
				LU	LCF	LH	OAL	LF	PL	DCON	
4.6	3	□	MNS0460S-DIN	17.1	23.8	28.8	65.8	65	0.8	6	4
	3	□	MNS0460S-DIN-C	16.9	23.8	28.8	65.8	65	0.8	6	3
	5	□	MNS0460L-DIN	28.9	35.8	36.8	73.8	73	0.8	6	4
	5	□	MNS0460L-DIN-C	28.9	35.8	36.8	73.8	73	0.8	6	3
	8	□	MNS0460-L8C	37.6	55.8	58.8	95.8	95	0.8	6	3
	10	□	MNS0460-L10C	46.8	65.8	68.8	105.8	105	0.8	6	3
	12	□	MNS0460-L12C	56.0	75.8	78.8	115.8	115	0.8	6	3
	15	□	MNS0460-L15C	69.8	90.8	93.8	130.8	130	0.8	6	3
	20	□	MNS0460-L20C	92.8	115.8	118.8	155.8	155	0.8	6	3
	25	□	MNS0460-L25C	115.8	140.8	143.8	180.8	180	0.8	6	3
	30	□	MNS0460-L30C	138.8	165.8	168.8	205.8	205	0.8	6	3
	5	★	MNS0460LB	23.8	55.8	55.8	105.8	105	0.8	5	3
	10	□	MNS0460X10DB	46.8	65.8	68.8	118.8	118	0.8	5	3
	20	□	MNS0460X20DB	92.8	115.8	118.8	168.8	168	0.8	5	3
30	□	MNS0460X30DB	138.8	165.8	168.8	218.8	218	0.8	5	3	
4.65	3	□	MNS0465S-DIN	16.9	23.8	28.8	65.8	65	0.8	6	4
	3	□	MNS0465S-DIN-C	16.9	23.8	28.8	65.8	65	0.8	6	3
	5	□	MNS0465L-DIN	28.9	35.8	36.8	73.8	73	0.8	6	4
	5	●	MNS0465L-DIN-C	28.9	35.8	36.8	73.8	73	0.8	6	3
4.7	3	□	MNS0470S-DIN	16.8	23.9	28.9	65.9	65	0.9	6	4
	3	□	MNS0470S-DIN-C	16.8	23.9	28.9	65.9	65	0.9	6	3
	5	□	MNS0470L-DIN	28.8	35.9	36.9	73.9	73	0.9	6	4
	5	□	MNS0470L-DIN-C	28.8	35.9	36.9	73.9	73	0.9	6	3
	8	□	MNS0470-L8C	38.5	55.9	58.9	95.9	95	0.9	6	3
	10	□	MNS0470-L10C	47.9	65.9	68.9	105.9	105	0.9	6	3
	12	□	MNS0470-L12C	57.3	75.9	78.9	115.9	115	0.9	6	3
	15	□	MNS0470-L15C	71.4	90.9	93.9	130.9	130	0.9	6	3
	20	□	MNS0470-L20C	94.9	115.9	118.9	155.9	155	0.9	6	3
	25	□	MNS0470-L25C	118.4	140.9	143.9	180.9	180	0.9	6	3
	30	□	MNS0470-L30C	141.9	165.9	168.9	205.9	205	0.9	6	3
	5	★	MNS0470LB	24.4	55.9	55.9	105.9	105	0.9	5	3
	10	□	MNS0470X10DB	47.9	65.9	68.9	118.9	118	0.9	5	3
	20	□	MNS0470X20DB	94.9	115.9	118.9	168.9	168	0.9	5	3
30	□	MNS0470X30DB	141.9	165.9	168.9	218.9	218	0.9	5	3	
4.8	3	□	MNS0480S-DIN	20.7	27.9	28.9	65.9	65	0.9	6	4
	3	□	MNS0480S-DIN-C	20.7	27.9	28.9	65.9	65	0.9	6	3
	5	□	MNS0480L-DIN	36.7	43.9	44.9	81.9	81	0.9	6	4
	5	□	MNS0480L-DIN-C	36.7	43.9	44.9	81.9	81	0.9	6	3
	8	□	MNS0480-L8C	39.3	55.9	58.9	95.9	95	0.9	6	3
	10	□	MNS0480-L10C	48.9	65.9	68.9	105.9	105	0.9	6	3
	12	□	MNS0480-L12C	58.5	75.9	78.9	115.9	115	0.9	6	3
	15	□	MNS0480-L15C	72.9	90.9	93.9	130.9	130	0.9	6	3
	20	□	MNS0480-L20C	96.9	115.9	118.9	155.9	155	0.9	6	3
	25	□	MNS0480-L25C	120.9	140.9	143.9	180.9	180	0.9	6	3
	30	□	MNS0480-L30C	144.9	165.9	168.9	205.9	205	0.9	6	3
	5	★	MNS0480LB	24.9	55.9	55.9	105.9	105	0.9	5	3
	10	□	MNS0480X10DB	48.9	65.9	68.9	118.9	118	0.9	5	3
	20	□	MNS0480X20DB	96.9	115.9	118.9	168.9	168	0.9	5	3
30	□	MNS0480X30DB	144.9	165.9	168.9	218.9	218	0.9	5	3	

DC (mm)	Głębokość otworu (L/D)	TF15	Numer zamówieniowy	Wymiary (mm)							Typ
				LU	LCF	LH	OAL	LF	PL	DCON	
4.9	3	□	MNS0490S-DIN	20.5	27.9	28.9	65.9	65	0.9	6	4
	3	□	MNS0490S-DIN-C	20.5	27.9	28.9	65.9	65	0.9	6	3
	5	□	MNS0490L-DIN	36.5	43.9	44.9	81.9	81	0.9	6	4
	5	□	MNS0490L-DIN-C	36.5	43.9	44.9	81.9	81	0.9	6	3
	8	□	MNS0490-L8C	40.1	55.9	58.9	95.9	95	0.9	6	3
	10	□	MNS0490-L10C	49.9	65.9	68.9	105.9	105	0.9	6	3
	12	□	MNS0490-L12C	59.7	75.9	78.9	115.9	115	0.9	6	3
	15	□	MNS0490-L15C	74.4	90.9	93.9	130.9	130	0.9	6	3
	20	□	MNS0490-L20C	98.9	115.9	118.9	155.9	155	0.9	6	3
	25	□	MNS0490-L25C	123.4	140.9	143.9	180.9	180	0.9	6	3
	30	□	MNS0490-L30C	147.9	165.9	168.9	205.9	205	0.9	6	3
	5	★	MNS0490LB	25.4	55.9	55.9	105.9	105	0.9	5	3
	10	★	MNS0490X10DB	49.9	65.9	68.9	118.9	118	0.9	5	3
	20	★	MNS0490X20DB	98.9	115.9	118.9	168.9	168	0.9	5	3
30	★	MNS0490X30DB	147.9	165.9	168.9	218.9	218	0.9	5	3	
5.0	3	□	MNS0500S-DIN	20.4	27.9	28.9	65.9	65	0.9	6	4
	3	□	MNS0500S-DIN-C	20.4	27.9	28.9	65.9	65	0.9	6	3
	5	□	MNS0500L-DIN	36.4	43.9	44.9	81.9	81	0.9	6	4
	5	●	MNS0500L-DIN-C	36.4	43.9	44.9	81.9	81	0.9	6	3
	8	□	MNS0500-L8C	40.9	55.9	58.9	95.9	95	0.9	6	3
	10	□	MNS0500-L10C	50.9	65.9	68.9	105.9	105	0.9	6	3
	12	●	MNS0500-L12C	60.9	75.9	78.9	115.9	115	0.9	6	3
	15	□	MNS0500-L15C	75.9	90.9	93.9	130.9	130	0.9	6	3
	20	●	MNS0500-L20C	100.9	115.9	118.9	155.9	155	0.9	6	3
	25	□	MNS0500-L25C	125.9	140.9	143.9	180.9	180	0.9	6	3
	30	●	MNS0500-L30C	150.9	165.9	168.9	205.9	205	0.9	6	3
	5	★	MNS0500LB	25.9	44.9	44.9	100.9	100	0.9	6	3
	10	★	MNS0500X10DB	50.9	65.9	68.9	118.9	118	0.9	5	3
	20	★	MNS0500X20DB	100.9	115.9	118.9	168.9	168	0.9	5	3
30	★	MNS0500X30DB	150.9	165.9	168.9	218.9	218	0.9	5	3	
5.1	3	□	MNS0510S-DIN	20.3	27.9	28.9	65.9	65	0.9	6	4
	3	□	MNS0510S-DIN-C	20.3	27.9	28.9	65.9	65	0.9	6	3
	5	□	MNS0510L-DIN	36.3	43.9	44.9	81.9	81	0.9	6	4
	5	●	MNS0510L-DIN-C	36.3	43.9	44.9	81.9	81	0.9	6	3
	8	□	MNS0510-L8C	41.7	61.9	64.9	101.9	101	0.9	6	3
	10	□	MNS0510-L10C	51.9	72.9	75.9	112.9	112	0.9	6	3
	12	□	MNS0510-L12C	62.1	83.9	86.9	123.9	123	0.9	6	3
	15	□	MNS0510-L15C	77.4	99.9	102.9	139.9	139	0.9	6	3
	20	□	MNS0510-L20C	102.9	127.9	130.9	167.9	167	0.9	6	3
	25	□	MNS0510-L25C	128.4	154.9	157.9	194.9	194	0.9	6	3
	30	□	MNS0510-L30C	153.9	182.9	185.9	222.9	222	0.9	6	3
	5	★	MNS0510LB	26.4	44.9	44.9	100.9	100	0.9	6	3
	10	★	MNS0510X10DB	51.9	72.9	75.9	127.9	127	0.9	6	3
	20	★	MNS0510X20DB	102.9	127.9	130.9	182.9	182	0.9	6	3
30	★	MNS0510X30DB	153.9	182.9	185.9	237.9	237	0.9	6	3	

DC (mm)	Głębokość otworu (L/D)	TF15	Numer zamówieniowy	Wymiary (mm)							Typ
				LU	LCF	LH	OAL	LF	PL	DCON	
5.2	3	□	MNS0520S-DIN	20.1	27.9	28.9	65.9	65	0.9	6	4
	3	□	MNS0520S-DIN-C	20.1	27.9	28.9	65.9	65	0.9	6	3
	5	□	MNS0520L-DIN	36.1	43.9	44.9	81.9	81	0.9	6	4
	5	□	MNS0520L-DIN-C	36.1	43.9	44.9	81.9	81	0.9	6	3
	8	□	MNS0520-L8C	42.5	61.9	64.9	101.9	101	0.9	6	3
	10	□	MNS0520-L10C	52.9	72.9	75.9	112.9	112	0.9	6	3
	12	□	MNS0520-L12C	63.3	83.9	86.9	123.9	123	0.9	6	3
	15	□	MNS0520-L15C	78.9	99.9	102.9	139.9	139	0.9	6	3
	20	□	MNS0520-L20C	104.9	127.9	130.9	167.9	167	0.9	6	3
	25	□	MNS0520-L25C	130.9	154.9	157.9	194.9	194	0.9	6	3
	30	□	MNS0520-L30C	156.9	182.9	185.9	222.9	222	0.9	6	3
	5	★	MNS0520LB	26.9	44.9	44.9	100.9	100	0.9	6	3
	10	□	MNS0520X10DB	52.9	72.9	75.9	127.9	127	0.9	6	3
20	□	MNS0520X20DB	104.9	127.9	130.9	182.9	182	0.9	6	3	
30	□	MNS0520X30DB	156.9	182.9	185.9	237.9	237	0.9	6	3	
5.3	3	□	MNS0530S-DIN	20.0	28.0	29.0	66.0	65	1.0	6	4
	3	□	MNS0530S-DIN-C	20.0	28.0	29.0	66.0	65	1.0	6	3
	5	□	MNS0530L-DIN	36.0	44.0	45.0	82.0	81	1.0	6	4
	5	□	MNS0530L-DIN-C	36.0	44.0	45.0	82.0	81	1.0	6	3
	8	□	MNS0530-L8C	43.4	62.0	65.0	102.0	101	1.0	6	3
	10	□	MNS0530-L10C	54.0	73.0	76.0	113.0	112	1.0	6	3
	12	□	MNS0530-L12C	64.6	84.0	87.0	124.0	123	1.0	6	3
	15	□	MNS0530-L15C	80.5	100.0	103.0	140.0	139	1.0	6	3
	20	□	MNS0530-L20C	107.0	128.0	131.0	168.0	167	1.0	6	3
	25	□	MNS0530-L25C	133.5	155.0	158.0	195.0	194	1.0	6	3
	30	□	MNS0530-L30C	160.0	183.0	186.0	223.0	222	1.0	6	3
	5	★	MNS0530LB	27.5	45.0	45.0	101.0	100	1.0	6	3
	10	□	MNS0530X10DB	54.0	73.0	76.0	128.0	127	1.0	6	3
20	□	MNS0530X20DB	107.0	128.0	131.0	183.0	182	1.0	6	3	
30	□	MNS0530X30DB	160.0	183.0	186.0	238.0	237	1.0	6	3	
5.4	3	□	MNS0540S-DIN	19.9	28.0	29.0	66.0	65	1.0	6	4
	3	□	MNS0540S-DIN-C	19.9	28.0	29.0	66.0	65	1.0	6	3
	5	□	MNS0540L-DIN	35.9	44.0	45.0	82.0	81	1.0	6	4
	5	□	MNS0540L-DIN-C	35.9	44.0	45.0	82.0	81	1.0	6	3
	8	□	MNS0540-L8C	44.2	62.0	65.0	102.0	101	1.0	6	3
	10	□	MNS0540-L10C	55.0	73.0	76.0	113.0	112	1.0	6	3
	12	□	MNS0540-L12C	65.8	84.0	87.0	124.0	123	1.0	6	3
	15	□	MNS0540-L15C	82.0	100.0	103.0	140.0	139	1.0	6	3
	20	□	MNS0540-L20C	109.0	128.0	131.0	168.0	167	1.0	6	3
	25	□	MNS0540-L25C	136.0	155.0	158.0	195.0	194	1.0	6	3
	30	□	MNS0540-L30C	163.0	183.0	186.0	223.0	222	1.0	6	3
	5	★	MNS0540LB	28.0	45.0	45.0	101.0	100	1.0	6	3
	10	□	MNS0540X10DB	55.0	73.0	76.0	128.0	127	1.0	6	3
20	□	MNS0540X20DB	109.0	128.0	131.0	183.0	182	1.0	6	3	
30	□	MNS0540X30DB	163.0	183.0	186.0	238.0	237	1.0	6	3	

DC (mm)	Głębokość otworu (L/D)	TF15	Numer zamówieniowy	Wymiary (mm)							Typ
				LU	LCF	LH	OAL	LF	PL	DCON	
5.5	3	□	MNS0550S-DIN	19.8	28.0	29.0	66.0	65	1.0	6	4
	3	□	MNS0550S-DIN-C	19.8	28.0	29.0	66.0	65	1.0	6	3
	5	□	MNS0550L-DIN	35.8	44.0	45.0	82.0	81	1.0	6	4
	5	●	MNS0550L-DIN-C	35.8	44.0	45.0	82.0	81	1.0	6	3
	8	□	MNS0550-L8C	45.0	62.0	65.0	102.0	101	1.0	6	3
	10	□	MNS0550-L10C	56.0	73.0	76.0	113.0	112	1.0	6	3
	12	●	MNS0550-L12C	67.0	84.0	87.0	124.0	123	1.0	6	3
	15	□	MNS0550-L15C	83.5	100.0	103.0	140.0	139	1.0	6	3
	20	●	MNS0550-L20C	111.0	128.0	131.0	168.0	167	1.0	6	3
	25	□	MNS0550-L25C	138.5	155.0	158.0	195.0	194	1.0	6	3
	30	●	MNS0550-L30C	166.0	183.0	186.0	223.0	222	1.0	6	3
	5	★	MNS0550LB	28.5	45.0	45.0	101.0	100	1.0	6	3
	10	★	MNS0550X10DB	56.0	73.0	76.0	128.0	127	1.0	6	3
20	★	MNS0550X20DB	111.0	128.0	131.0	183.0	182	1.0	6	3	
30	★	MNS0550X30DB	166.0	183.0	186.0	238.0	237	1.0	6	3	
5.55	3	□	MNS0555S-DIN	19.7	28.0	29.0	66.0	65	1.0	6	4
	3	□	MNS0555S-DIN-C	19.7	28.0	29.0	66.0	65	1.0	6	3
	5	□	MNS0555L-DIN	35.7	44.0	45.0	82.0	81	1.0	6	4
	5	●	MNS0555L-DIN-C	35.7	44.0	45.0	82.0	81	1.0	6	3
	5	★	MNS0555LB	29.0	49.0	49.0	101.0	100	1.0	6	3
5.6	3	□	MNS0560S-DIN	19.6	28.0	29.0	66.0	65	1.0	6	4
	3	□	MNS0560S-DIN-C	19.6	28.0	29.0	66.0	65	1.0	6	3
	5	□	MNS0560L-DIN	35.6	44.0	45.0	82.0	81	1.0	6	4
	5	□	MNS0560L-DIN-C	35.6	44.0	45.0	82.0	81	1.0	6	3
	8	□	MNS0560-L8C	45.8	67.0	70.0	107.0	106	1.0	6	3
	10	□	MNS0560-L10C	57.0	79.0	82.0	119.0	118	1.0	6	3
	12	□	MNS0560-L12C	68.2	91.0	94.0	131.0	130	1.0	6	3
	15	□	MNS0560-L15C	85.0	109.0	112.0	149.0	148	1.0	6	3
	20	□	MNS0560-L20C	113.0	139.0	142.0	179.0	178	1.0	6	3
	25	□	MNS0560-L25C	141.0	169.0	172.0	209.0	208	1.0	6	3
	30	□	MNS0560-L30C	169.0	199.0	202.0	239.0	238	1.0	6	3
	5	★	MNS0560LB	29.0	49.0	49.0	101.0	100	1.0	6	3
	10	□	MNS0560X10DB	57.0	79.0	82.0	134.0	133	1.0	6	3
20	□	MNS0560X20DB	113.0	139.0	142.0	194.0	193	1.0	6	3	
30	□	MNS0560X30DB	169.0	199.0	202.0	254.0	253	1.0	6	3	
5.7	3	□	MNS0570S-DIN	19.5	28.0	29.0	66.0	65	1.0	6	4
	3	□	MNS0570S-DIN-C	19.5	28.0	29.0	66.0	65	1.0	6	3
	5	□	MNS0570L-DIN	35.5	44.0	45.0	82.0	81	1.0	6	4
	5	□	MNS0570L-DIN-C	35.5	44.0	45.0	82.0	81	1.0	6	3
	8	□	MNS0570-L8C	46.6	67.0	70.0	107.0	106	1.0	6	3
	10	□	MNS0570-L10C	58.0	79.0	82.0	119.0	118	1.0	6	3
	12	□	MNS0570-L12C	69.4	91.0	94.0	131.0	130	1.0	6	3
	15	□	MNS0570-L15C	86.5	109.0	112.0	149.0	148	1.0	6	3
	20	□	MNS0570-L20C	115.0	139.0	142.0	179.0	178	1.0	6	3
	25	□	MNS0570-L25C	143.5	169.0	172.0	209.0	208	1.0	6	3
	30	□	MNS0570-L30C	172.0	199.0	202.0	239.0	238	1.0	6	3
	5	★	MNS0570LB	29.5	49.0	49.0	101.0	100	1.0	6	3
	10	□	MNS0570X10DB	58.0	79.0	82.0	134.0	133	1.0	6	3
20	□	MNS0570X20DB	115.0	139.0	142.0	194.0	193	1.0	6	3	
30	□	MNS0570X30DB	172.0	199.0	202.0	254.0	253	1.0	6	3	

Uwaga 1) Gdy geometria wiertła nie odpowiada wartościom podanym w tabeli (np. inna średnica i długość wiertła), prosimy o skontaktowanie się z naszą firmą.

● : Standard magazynowy. ★ : Na specjalne zamówienie z magazynu w Japonii.

□ : Niestandardowy, produkowany na specjalne zamówienie.

DC (mm)	Głębokość otworu (L/D)	TF15	Numer zamówieniowy	Wymiary (mm)							Typ
				LU	LCF	LH	OAL	LF	PL	DCON	
5.8	3	□	MNS0580S-DIN	19.4	28.1	29.1	66.1	65	1.1	6	4
	3	□	MNS0580S-DIN-C	19.4	28.1	29.1	66.1	65	1.1	6	3
	5	□	MNS0580L-DIN	35.4	44.1	45.1	82.1	81	1.1	6	4
	5	□	MNS0580L-DIN-C	35.4	44.1	45.1	82.1	81	1.1	6	3
	8	□	MNS0580-L8C	47.5	67.1	70.1	107.1	106	1.1	6	3
	10	□	MNS0580-L10C	59.1	79.1	82.1	119.1	118	1.1	6	3
	12	□	MNS0580-L12C	70.7	91.1	94.1	131.1	130	1.1	6	3
	15	□	MNS0580-L15C	88.1	109.1	112.1	149.1	148	1.1	6	3
	20	□	MNS0580-L20C	117.1	139.1	142.1	179.1	178	1.1	6	3
	25	□	MNS0580-L25C	146.1	169.1	172.1	209.1	208	1.1	6	3
	30	□	MNS0580-L30C	175.1	199.1	202.1	239.1	238	1.1	6	3
	5	★	MNS0580LB	30.1	49.1	49.1	101.1	100	1.1	6	3
	10	□	MNS0580X10DB	59.1	79.1	82.1	134.1	133	1.1	6	3
	20	□	MNS0580X20DB	117.1	139.1	142.1	194.1	193	1.1	6	3
30	□	MNS0580X30DB	175.1	199.1	202.1	254.1	253	1.1	6	3	
5.9	3	□	MNS0590S-DIN	19.2	28.1	29.1	66.1	65	1.1	6	4
	3	□	MNS0590S-DIN-C	19.2	28.1	29.1	66.1	65	1.1	6	3
	5	□	MNS0590L-DIN	35.2	44.1	45.1	82.1	81	1.1	6	4
	5	□	MNS0590L-DIN-C	35.2	44.1	45.1	82.1	81	1.1	6	3
	8	□	MNS0590-L8C	48.3	67.1	70.1	107.1	106	1.1	6	3
	10	□	MNS0590-L10C	60.1	79.1	82.1	119.1	118	1.1	6	3
	12	□	MNS0590-L12C	71.9	91.1	94.1	131.1	130	1.1	6	3
	15	□	MNS0590-L15C	89.6	109.1	112.1	149.1	148	1.1	6	3
	20	□	MNS0590-L20C	119.1	139.1	142.1	179.1	178	1.1	6	3
	25	□	MNS0590-L25C	148.6	169.1	172.1	209.1	208	1.1	6	3
	30	□	MNS0590-L30C	178.1	199.1	202.1	239.1	238	1.1	6	3
	5	★	MNS0590LB	30.6	49.1	49.1	101.1	100	1.1	6	3
	10	□	MNS0590X10DB	60.1	79.1	82.1	134.1	133	1.1	6	3
	20	□	MNS0590X20DB	119.1	139.1	142.1	194.1	193	1.1	6	3
30	□	MNS0590X30DB	178.1	199.1	202.1	254.1	253	1.1	6	3	
6.0	3	□	MNS0600S-DIN	19.1	28.1	29.1	66.1	65	1.1	6	4
	3	□	MNS0600S-DIN-C	19.1	28.1	29.1	66.1	65	1.1	6	3
	5	●	MNS0600L-DIN-C	35.1	44.1	45.1	82.1	81	1.1	6	3
	8	□	MNS0600-L8C	49.1	67.1	70.1	107.1	106	1.1	6	3
	10	□	MNS0600-L10C	61.1	79.1	82.1	119.1	118	1.1	6	3
	12	●	MNS0600-L12C	73.1	91.1	94.1	131.1	130	1.1	6	3
	15	□	MNS0600-L15C	91.1	109.1	112.1	149.1	148	1.1	6	3
	20	●	MNS0600-L20C	121.1	139.1	142.1	179.1	178	1.1	6	3
	25	□	MNS0600-L25C	151.1	169.1	172.1	209.1	208	1.1	6	3
	30	●	MNS0600-L30C	181.1	199.1	202.1	239.1	238	1.1	6	3
	5	★	MNS0600LB	31.1	49.1	49.1	101.1	100	1.1	6	3
	10	★	MNS0600X10DB	61.1	79.1	82.1	134.1	133	1.1	6	3
	20	★	MNS0600X20DB	121.1	139.1	142.1	194.1	193	1.1	6	3
	30	★	MNS0600X30DB	181.1	199.1	202.1	254.1	253	1.1	6	3

DC (mm)	Głębokość otworu (L/D)	TF15	Numer zamówieniowy	Wymiary (mm)							Typ
				LU	LCF	LH	OAL	LF	PL	DCON	
6.1	3	□	MNS0610S-DIN	25.0	34.1	42.1	79.1	78	1.1	8	4
	3	□	MNS0610S-DIN-C	25.0	34.1	42.1	79.1	78	1.1	8	3
	5	□	MNS0610L-DIN	44.0	53.1	54.1	91.1	90	1.1	8	4
	5	□	MNS0610L-DIN-C	44.0	53.1	54.1	91.1	90	1.1	8	3
	8	□	MNS0610-L8C	49.9	73.1	76.1	113.1	112	1.1	8	3
	10	□	MNS0610-L10C	62.1	86.1	89.1	126.1	125	1.1	8	3
	12	□	MNS0610-L12C	74.3	99.1	102.1	139.1	138	1.1	8	3
	15	□	MNS0610-L15C	92.6	118.1	121.1	158.1	157	1.1	8	3
	20	□	MNS0610-L20C	123.1	151.1	154.1	191.1	190	1.1	8	3
	25	□	MNS0610-L25C	153.6	183.1	186.1	223.1	222	1.1	8	3
	30	□	MNS0610-L30C	184.1	216.1	219.1	256.1	255	1.1	8	3
	5	★	MNS0610LB	31.6	53.1	53.1	110.1	109	1.1	7	3
	10	★	MNS0610X10DB	62.1	86.1	89.1	142.1	141	1.1	7	3
	20	★	MNS0610X20DB	123.1	151.1	154.1	207.1	206	1.1	7	3
30	★	MNS0610X30DB	184.1	216.1	219.1	272.1	271	1.1	7	3	
6.2	3	□	MNS0620S-DIN	24.8	34.1	42.1	79.1	78	1.1	8	4
	3	□	MNS0620S-DIN-C	24.8	34.1	42.1	79.1	78	1.1	8	3
	5	□	MNS0620L-DIN	43.8	53.1	54.1	91.1	90	1.1	8	4
	5	□	MNS0620L-DIN-C	43.8	53.1	54.1	91.1	90	1.1	8	3
	8	□	MNS0620-L8C	50.7	73.1	76.1	113.1	112	1.1	8	3
	10	□	MNS0620-L10C	63.1	86.1	89.1	126.1	125	1.1	8	3
	12	□	MNS0620-L12C	75.5	99.1	102.1	139.1	138	1.1	8	3
	15	□	MNS0620-L15C	94.1	118.1	121.1	158.1	157	1.1	8	3
	20	□	MNS0620-L20C	125.1	151.1	154.1	191.1	190	1.1	8	3
	25	□	MNS0620-L25C	156.1	183.1	186.1	223.1	222	1.1	8	3
	30	□	MNS0620-L30C	187.1	216.1	219.1	256.1	255	1.1	8	3
	5	★	MNS0620LB	32.1	53.1	53.1	110.1	109	1.1	7	3
	10	□	MNS0620X10DB	63.1	86.1	89.1	142.1	141	1.1	7	3
	20	□	MNS0620X20DB	125.1	151.1	154.1	207.1	206	1.1	7	3
30	□	MNS0620X30DB	187.1	216.1	219.1	272.1	271	1.1	7	3	
6.3	3	□	MNS0630S-DIN	24.7	34.1	42.1	79.1	78	1.1	8	4
	3	□	MNS0630S-DIN-C	24.7	34.1	42.1	79.1	78	1.1	8	3
	5	□	MNS0630L-DIN	43.7	53.1	54.1	91.1	90	1.1	8	4
	5	□	MNS0630L-DIN-C	43.7	53.1	54.1	91.1	90	1.1	8	3
	8	□	MNS0630-L8C	51.5	73.1	76.1	113.1	112	1.1	8	3
	10	□	MNS0630-L10C	64.1	86.1	89.1	126.1	125	1.1	8	3
	12	□	MNS0630-L12C	76.7	99.1	102.1	139.1	138	1.1	8	3
	15	□	MNS0630-L15C	95.6	118.1	121.1	158.1	157	1.1	8	3
	20	□	MNS0630-L20C	127.1	151.1	154.1	191.1	190	1.1	8	3
	25	□	MNS0630-L25C	158.6	183.1	186.1	223.1	222	1.1	8	3
	30	□	MNS0630-L30C	190.1	216.1	219.1	256.1	255	1.1	8	3
	5	★	MNS0630LB	32.6	53.1	53.1	110.1	109	1.1	7	3
	10	□	MNS0630X10DB	64.1	86.1	89.1	142.1	141	1.1	7	3
	20	□	MNS0630X20DB	127.1	151.1	154.1	207.1	206	1.1	7	3
30	□	MNS0630X30DB	190.1	216.1	219.1	272.1	271	1.1	7	3	

WIERCENIE (WIERTŁA PEŁNOWĘGLIKOWE)

MNS

WĘGLIKI
SPIEKANE

M

WIERCENIE

DC (mm)	Głębokość otworu (L/D)	TF15	Numer zamówieniowy	Wymiary (mm)							Typ
				LU	LCF	LH	OAL	LF	PL	DCON	
6.4	3	□	MNS0640S-DIN	24.6	34.2	42.2	79.2	78	1.2	8	4
	3	□	MNS0640S-DIN-C	24.6	34.2	42.2	79.2	78	1.2	8	3
	5	□	MNS0640L-DIN	43.6	53.2	54.2	91.2	90	1.2	8	4
	5	□	MNS0640L-DIN-C	43.6	53.2	54.2	91.2	90	1.2	8	3
	8	□	MNS0640-L8C	52.4	73.2	76.2	113.2	112	1.2	8	3
	10	□	MNS0640-L10C	65.2	86.2	89.2	126.2	125	1.2	8	3
	12	□	MNS0640-L12C	78.0	99.2	102.2	139.2	138	1.2	8	3
	15	□	MNS0640-L15C	97.2	118.2	121.2	158.2	157	1.2	8	3
	20	□	MNS0640-L20C	129.2	151.2	154.2	191.2	190	1.2	8	3
	25	□	MNS0640-L25C	161.2	183.2	186.2	223.2	222	1.2	8	3
	30	□	MNS0640-L30C	193.2	216.2	219.2	256.2	255	1.2	8	3
	5	★	MNS0640LB	33.2	53.2	53.2	110.2	109	1.2	7	3
	10	□	MNS0640X10DB	65.2	86.2	89.2	142.2	141	1.2	7	3
20	□	MNS0640X20DB	129.2	151.2	154.2	207.2	206	1.2	7	3	
30	□	MNS0640X30DB	193.2	216.2	219.2	272.2	271	1.2	7	3	
6.5	3	□	MNS0650S-DIN	24.4	34.2	42.2	79.2	78	1.2	8	4
	3	□	MNS0650S-DIN-C	24.4	34.2	42.2	79.2	78	1.2	8	3
	5	□	MNS0650L-DIN	43.4	53.2	54.2	91.2	90	1.2	8	4
	5	●	MNS0650L-DIN-C	43.4	53.2	54.2	91.2	90	1.2	8	3
	8	□	MNS0650-L8C	53.2	73.2	76.2	113.2	112	1.2	8	3
	10	□	MNS0650-L10C	66.2	86.2	89.2	126.2	125	1.2	8	3
	12	●	MNS0650-L12C	79.2	99.2	102.2	139.2	138	1.2	8	3
	15	□	MNS0650-L15C	98.7	118.2	121.2	158.2	157	1.2	8	3
	20	●	MNS0650-L20C	131.2	151.2	154.2	191.2	190	1.2	8	3
	25	□	MNS0650-L25C	163.7	183.2	186.2	223.2	222	1.2	8	3
	30	●	MNS0650-L30C	196.2	216.2	219.2	256.2	255	1.2	8	3
	5	★	MNS0650LB	33.7	53.2	53.2	110.2	109	1.2	7	3
	10	★	MNS0650X10DB	66.2	86.2	89.2	142.2	141	1.2	7	3
20	★	MNS0650X20DB	131.2	151.2	154.2	207.2	206	1.2	7	3	
30	★	MNS0650X30DB	196.2	216.2	219.2	272.2	271	1.2	7	3	
6.6	3	□	MNS0660S-DIN	24.3	34.2	42.2	79.2	78	1.2	8	4
	3	□	MNS0660S-DIN-C	24.3	34.2	42.2	79.2	78	1.2	8	3
	5	□	MNS0660L-DIN	43.3	53.2	54.2	91.2	90	1.2	8	4
	5	□	MNS0660L-DIN-C	43.3	53.2	54.2	91.2	90	1.2	8	3
	8	□	MNS0660-L8C	54.0	78.2	81.2	118.2	117	1.2	8	3
	10	□	MNS0660-L10C	67.2	92.2	95.2	132.2	131	1.2	8	3
	12	□	MNS0660-L12C	80.4	106.2	109.2	146.2	145	1.2	8	3
	15	□	MNS0660-L15C	100.2	127.2	130.2	167.2	166	1.2	8	3
	20	□	MNS0660-L20C	133.2	162.2	165.2	202.2	201	1.2	8	3
	25	□	MNS0660-L25C	166.2	197.2	200.2	237.2	236	1.2	8	3
	30	□	MNS0660-L30C	199.2	232.2	235.2	272.2	271	1.2	8	3
	5	★	MNS0660LB	34.2	57.2	57.2	110.2	109	1.2	7	3
	10	□	MNS0660X10DB	67.2	92.2	95.2	148.2	147	1.2	7	3
20	□	MNS0660X20DB	133.2	162.2	165.2	218.2	217	1.2	7	3	
30	□	MNS0660X30DB	199.2	232.2	235.2	288.2	287	1.2	7	3	

DC (mm)	Głębokość otworu (L/D)	TF15	Numer zamówieniowy	Wymiary (mm)							Typ
				LU	LCF	LH	OAL	LF	PL	DCON	
6.7	3	□	MNS0670S-DIN	24.2	34.2	42.2	79.2	78	1.2	8	4
	3	□	MNS0670S-DIN-C	24.2	34.2	42.2	79.2	78	1.2	8	3
	5	□	MNS0670L-DIN	43.2	53.2	54.2	91.2	90	1.2	8	4
	5	□	MNS0670L-DIN-C	43.2	53.2	54.2	91.2	90	1.2	8	3
	8	□	MNS0670-L8C	54.8	78.2	81.2	118.2	117	1.2	8	3
	10	□	MNS0670-L10C	68.2	92.2	95.2	132.2	131	1.2	8	3
	12	□	MNS0670-L12C	81.6	106.2	109.2	146.2	145	1.2	8	3
	15	□	MNS0670-L15C	101.7	127.2	130.2	167.2	166	1.2	8	3
	20	□	MNS0670-L20C	135.2	162.2	165.2	202.2	201	1.2	8	3
	25	□	MNS0670-L25C	168.7	197.2	200.2	237.2	236	1.2	8	3
	30	□	MNS0670-L30C	202.2	232.2	235.2	272.2	271	1.2	8	3
	5	★	MNS0670LB	34.7	57.2	57.2	110.2	109	1.2	7	3
	10	★	MNS0670X10DB	68.2	92.2	95.2	148.2	147	1.2	7	3
20	★	MNS0670X20DB	135.2	162.2	165.2	218.2	217	1.2	7	3	
30	★	MNS0670X30DB	202.2	232.2	235.2	288.2	287	1.2	7	3	
6.8	3	□	MNS0680S-DIN	24.0	34.2	42.2	79.2	78	1.2	8	4
	3	□	MNS0680S-DIN-C	24.0	34.2	42.2	79.2	78	1.2	8	3
	5	□	MNS0680L-DIN	43.0	53.2	54.2	91.2	90	1.2	8	4
	5	●	MNS0680L-DIN-C	43.0	53.2	54.2	91.2	90	1.2	8	3
	8	□	MNS0680-L8C	55.6	78.2	81.2	118.2	117	1.2	8	3
	10	□	MNS0680-L10C	69.2	92.2	95.2	132.2	131	1.2	8	3
	12	●	MNS0680-L12C	82.8	106.2	109.2	146.2	145	1.2	8	3
	15	□	MNS0680-L15C	103.2	127.2	130.2	167.2	166	1.2	8	3
	20	●	MNS0680-L20C	137.2	162.2	165.2	202.2	201	1.2	8	3
	25	□	MNS0680-L25C	171.2	197.2	200.2	237.2	236	1.2	8	3
	30	●	MNS0680-L30C	205.2	232.2	235.2	272.2	271	1.2	8	3
	5	★	MNS0680LB	35.2	57.2	57.2	110.2	109	1.2	7	3
	10	□	MNS0680X10DB	69.2	92.2	95.2	148.2	147	1.2	7	3
20	□	MNS0680X20DB	137.2	162.2	165.2	218.2	217	1.2	7	3	
30	□	MNS0680X30DB	205.2	232.2	235.2	288.2	287	1.2	7	3	
6.9	3	□	MNS0690S-DIN	23.9	34.3	42.3	79.3	78	1.3	8	4
	3	□	MNS0690S-DIN-C	23.9	34.3	42.3	79.3	78	1.3	8	3
	5	□	MNS0690L-DIN	42.9	53.3	54.3	91.3	90	1.3	8	4
	5	□	MNS0690L-DIN-C	42.9	53.3	54.3	91.3	90	1.3	8	3
	8	□	MNS0690-L8C	56.5	78.3	81.3	118.3	117	1.3	8	3
	10	□	MNS0690-L10C	70.3	92.3	95.3	132.3	131	1.3	8	3
	12	□	MNS0690-L12C	84.1	106.3	109.3	146.3	145	1.3	8	3
	15	□	MNS0690-L15C	104.8	127.3	130.3	167.3	166	1.3	8	3
	20	□	MNS0690-L20C	139.3	162.3	165.3	202.3	201	1.3	8	3
	25	□	MNS0690-L25C	173.8	197.3	200.3	237.3	236	1.3	8	3
	30	□	MNS0690-L30C	208.3	232.3	235.3	272.3	271	1.3	8	3
	5	★	MNS0690LB	35.8	57.3	57.3	110.3	109	1.3	7	3
	10	□	MNS0690X10DB	70.3	92.3	95.3	148.3	147	1.3	7	3
20	□	MNS0690X20DB	139.3	162.3	165.3	218.3	217	1.3	7	3	
30	□	MNS0690X30DB	208.3	232.3	235.3	288.3	287	1.3	7	3	

Uwaga 1) Gdy geometria wiertła nie odpowiada wartościom podanym w tabeli (np. inna średnica i długość wiertła), prosimy o skontaktowanie się z naszą firmą.

● : Standard magazynowy. ★ : Na specjalne zamówienie z magazynu w Japonii.

□ : Niestandardowy, produkowany na specjalne zamówienie.

DC (mm)	Głębokość otworu (L/D)	TF15	Numer zamówieniowy	Wymiary (mm)							Typ
				LU	LCF	LH	OAL	LF	PL	DCON	
7.0	3	□	MNS0700S-DIN	23.8	34.3	42.3	79.3	78	1.3	8	4
	3	□	MNS0700S-DIN-C	23.8	34.3	42.3	79.3	78	1.3	8	3
	5	□	MNS0700L-DIN	42.8	53.3	54.3	91.3	90	1.3	8	4
	5	●	MNS0700L-DIN-C	42.8	53.3	54.3	91.3	90	1.3	8	3
	8	□	MNS0700-L8C	57.3	78.3	81.3	118.3	117	1.3	8	3
	10	□	MNS0700-L10C	71.3	92.3	95.3	132.3	131	1.3	8	3
	12	●	MNS0700-L12C	85.3	106.3	109.3	146.3	145	1.3	8	3
	15	□	MNS0700-L15C	106.3	127.3	130.3	167.3	166	1.3	8	3
	20	●	MNS0700-L20C	141.3	162.3	165.3	202.3	201	1.3	8	3
	25	□	MNS0700-L25C	176.3	197.3	200.3	237.3	236	1.3	8	3
	30	●	MNS0700-L30C	211.3	232.3	235.3	272.3	271	1.3	8	3
	5	★	MNS0700LB	36.3	57.3	57.3	110.3	109	1.3	7	3
	10	★	MNS0700X10DB	71.3	92.3	95.3	148.3	147	1.3	7	3
	20	★	MNS0700X20DB	141.3	162.3	165.3	218.3	217	1.3	7	3
30	★	MNS0700X30DB	211.3	232.3	235.3	288.3	287	1.3	7	3	
7.1	3	□	MNS0710S-DIN	30.6	41.3	42.3	79.3	78	1.3	8	4
	3	□	MNS0710S-DIN-C	30.6	41.3	42.3	79.3	78	1.3	8	3
	5	□	MNS0710L-DIN	42.6	53.3	54.3	91.3	90	1.3	8	4
	5	□	MNS0710L-DIN-C	42.6	53.3	54.3	91.3	90	1.3	8	3
	8	□	MNS0710-L8C	58.1	84.3	87.3	124.3	123	1.3	8	3
	10	□	MNS0710-L10C	72.3	99.3	102.3	139.3	138	1.3	8	3
	12	□	MNS0710-L12C	86.5	114.3	117.3	154.3	153	1.3	8	3
	15	□	MNS0710-L15C	107.8	136.3	139.3	176.3	175	1.3	8	3
	20	□	MNS0710-L20C	143.3	174.3	177.3	214.3	213	1.3	8	3
	25	□	MNS0710-L25C	178.8	211.3	214.3	251.3	250	1.3	8	3
	30	□	MNS0710-L30C	214.3	249.3	252.3	289.3	288	1.3	8	3
	5	★	MNS0710LB	36.8	61.3	65.3	119.3	118	1.3	8	3
	10	□	MNS0710X10DB	72.3	99.3	102.3	156.3	155	1.3	8	3
	20	□	MNS0710X20DB	143.3	174.3	177.3	231.3	230	1.3	8	3
30	□	MNS0710X30DB	214.3	249.3	252.3	306.3	305	1.3	8	3	
7.2	3	□	MNS0720S-DIN	30.5	41.3	42.3	79.3	78	1.3	8	4
	3	□	MNS0720S-DIN-C	30.5	41.3	42.3	79.3	78	1.3	8	3
	5	□	MNS0720L-DIN	42.5	53.3	54.3	91.3	90	1.3	8	4
	5	□	MNS0720L-DIN-C	42.5	53.3	54.3	91.3	90	1.3	8	3
	8	□	MNS0720-L8C	58.9	84.3	87.3	124.3	123	1.3	8	3
	10	□	MNS0720-L10C	73.3	99.3	102.3	139.3	138	1.3	8	3
	12	□	MNS0720-L12C	87.7	114.3	117.3	154.3	153	1.3	8	3
	15	□	MNS0720-L15C	109.3	136.3	139.3	176.3	175	1.3	8	3
	20	□	MNS0720-L20C	145.3	174.3	177.3	214.3	213	1.3	8	3
	25	□	MNS0720-L25C	181.3	211.3	214.3	251.3	250	1.3	8	3
	30	□	MNS0720-L30C	217.3	249.3	252.3	289.3	288	1.3	8	3
	5	★	MNS0720LB	37.3	61.3	65.3	119.3	118	1.3	8	3
	10	★	MNS0720X10DB	73.3	99.3	102.3	156.3	155	1.3	8	3
	20	★	MNS0720X20DB	145.3	174.3	177.3	231.3	230	1.3	8	3
30	★	MNS0720X30DB	217.3	249.3	252.3	306.3	305	1.3	8	3	

DC (mm)	Głębokość otworu (L/D)	TF15	Numer zamówieniowy	Wymiary (mm)							Typ
				LU	LCF	LH	OAL	LF	PL	DCON	
7.3	3	□	MNS0730S-DIN	30.4	41.3	42.3	79.3	78	1.3	8	4
	3	□	MNS0730S-DIN-C	30.4	41.3	42.3	79.3	78	1.3	8	3
	5	□	MNS0730L-DIN	42.4	53.3	54.3	91.3	90	1.3	8	4
	5	□	MNS0730L-DIN-C	42.4	53.3	54.3	91.3	90	1.3	8	3
	8	□	MNS0730-L8C	59.7	84.3	87.3	124.3	123	1.3	8	3
	10	□	MNS0730-L10C	74.3	99.3	102.3	139.3	138	1.3	8	3
	12	□	MNS0730-L12C	88.9	114.3	117.3	154.3	153	1.3	8	3
	15	□	MNS0730-L15C	110.8	136.3	139.3	176.3	175	1.3	8	3
	20	□	MNS0730-L20C	147.3	174.3	177.3	214.3	213	1.3	8	3
	25	□	MNS0730-L25C	183.8	211.3	214.3	251.3	250	1.3	8	3
	30	□	MNS0730-L30C	220.3	249.3	252.3	289.3	288	1.3	8	3
	5	★	MNS0730LB	37.8	61.3	65.3	119.3	118	1.3	8	3
	10	□	MNS0730X10DB	74.3	99.3	102.3	156.3	155	1.3	8	3
	20	□	MNS0730X20DB	147.3	174.3	177.3	231.3	230	1.3	8	3
30	□	MNS0730X30DB	220.3	249.3	252.3	306.3	305	1.3	8	3	
7.4	3	□	MNS0740S-DIN	30.2	41.3	42.3	79.3	78	1.3	8	4
	3	□	MNS0740S-DIN-C	30.2	41.3	42.3	79.3	78	1.3	8	3
	5	□	MNS0740L-DIN	42.2	53.3	54.3	91.3	90	1.3	8	4
	5	□	MNS0740L-DIN-C	42.2	53.3	54.3	91.3	90	1.3	8	3
	8	□	MNS0740-L8C	60.5	84.3	87.3	124.3	123	1.3	8	3
	10	□	MNS0740-L10C	75.3	99.3	102.3	139.3	138	1.3	8	3
	12	□	MNS0740-L12C	90.1	114.3	117.3	154.3	153	1.3	8	3
	15	□	MNS0740-L15C	112.3	136.3	139.3	176.3	175	1.3	8	3
	20	□	MNS0740-L20C	149.3	174.3	177.3	214.3	213	1.3	8	3
	25	□	MNS0740-L25C	186.3	211.3	214.3	251.3	250	1.3	8	3
	30	□	MNS0740-L30C	223.3	249.3	252.3	289.3	288	1.3	8	3
	5	★	MNS0740LB	38.3	61.3	65.3	119.3	118	1.3	8	3
	10	□	MNS0740X10DB	75.3	99.3	102.3	156.3	155	1.3	8	3
	20	□	MNS0740X20DB	149.3	174.3	177.3	231.3	230	1.3	8	3
30	□	MNS0740X30DB	223.3	249.3	252.3	306.3	305	1.3	8	3	
7.5	3	□	MNS0750S-DIN	30.1	41.4	42.4	79.4	78	1.4	8	4
	3	□	MNS0750S-DIN-C	30.1	41.4	42.4	79.4	78	1.4	8	3
	5	□	MNS0750L-DIN	42.1	53.4	54.4	91.4	90	1.4	8	4
	5	●	MNS0750L-DIN-C	42.1	53.4	54.4	91.4	90	1.4	8	3
	8	□	MNS0750-L8C	61.4	84.4	87.4	124.4	123	1.4	8	3
	10	□	MNS0750-L10C	76.4	99.4	102.4	139.4	138	1.4	8	3
	12	●	MNS0750-L12C	91.4	114.4	117.4	154.4	153	1.4	8	3
	15	□	MNS0750-L15C	113.9	136.4	139.4	176.4	175	1.4	8	3
	20	●	MNS0750-L20C	151.4	174.4	177.4	214.4	213	1.4	8	3
	25	□	MNS0750-L25C	188.9	211.4	214.4	251.4	250	1.4	8	3
	30	●	MNS0750-L30C	226.4	249.4	252.4	289.4	288	1.4	8	3
	5	★	MNS0750LB	38.9	61.4	65.4	119.4	118	1.4	8	3
	10	□	MNS0750X10DB	76.4	99.4	102.4	156.4	155	1.4	8	3
	20	□	MNS0750X20DB	151.4	174.4	177.4	231.4	230	1.4	8	3
30	□	MNS0750X30DB	226.4	249.4	252.4	306.4	305	1.4	8	3	

DC (mm)	Głębokość otworu (L/D)	TF15	Numer zamówieniowy	Wymiary (mm)							Typ
				LU	LCF	LH	OAL	LF	PL	DCON	
7.6	3	□	MNS0760S-DIN	30.0	41.4	42.4	79.4	78	1.4	8	4
	3	□	MNS0760S-DIN-C	30.0	41.4	42.4	79.4	78	1.4	8	3
	5	□	MNS0760L-DIN	42.0	53.4	54.4	91.4	90	1.4	8	4
	5	□	MNS0760L-DIN-C	42.0	53.4	54.4	91.4	90	1.4	8	3
	8	□	MNS0760-L8C	62.2	89.4	92.4	129.4	128	1.4	8	3
	10	□	MNS0760-L10C	77.4	105.4	108.4	145.4	144	1.4	8	3
	12	□	MNS0760-L12C	92.6	121.4	124.4	161.4	160	1.4	8	3
	15	□	MNS0760-L15C	115.4	145.4	148.4	185.4	184	1.4	8	3
	20	□	MNS0760-L20C	153.4	185.4	188.4	225.4	224	1.4	8	3
	25	□	MNS0760-L25C	191.4	225.4	228.4	265.4	264	1.4	8	3
	30	□	MNS0760-L30C	229.4	265.4	268.4	305.4	304	1.4	8	3
	5	★	MNS0760LB	39.4	65.4	65.4	119.4	118	1.4	8	3
10	□	MNS0760X10DB	77.4	105.4	108.4	162.4	161	1.4	8	3	
20	□	MNS0760X20DB	153.4	185.4	188.4	242.4	241	1.4	8	3	
30	□	MNS0760X30DB	229.4	265.4	268.4	322.4	321	1.4	8	3	
7.7	3	□	MNS0770S-DIN	29.9	41.4	42.4	79.4	78	1.4	8	4
	3	□	MNS0770S-DIN-C	29.9	41.4	42.4	79.4	78	1.4	8	3
	5	□	MNS0770L-DIN	41.9	53.4	54.4	91.4	90	1.4	8	4
	5	□	MNS0770L-DIN-C	41.9	53.4	54.4	91.4	90	1.4	8	3
	8	□	MNS0770-L8C	63.0	89.4	92.4	129.4	128	1.4	8	3
	10	□	MNS0770-L10C	78.4	105.4	108.4	145.4	144	1.4	8	3
	12	□	MNS0770-L12C	93.8	121.4	124.4	161.4	160	1.4	8	3
	15	□	MNS0770-L15C	116.9	145.4	148.4	185.4	184	1.4	8	3
	20	□	MNS0770-L20C	155.4	185.4	188.4	225.4	224	1.4	8	3
	25	□	MNS0770-L25C	193.9	225.4	228.4	265.4	264	1.4	8	3
	30	□	MNS0770-L30C	232.4	265.4	268.4	305.4	304	1.4	8	3
	5	★	MNS0770LB	39.9	65.4	65.4	119.4	118	1.4	8	3
10	□	MNS0770X10DB	78.4	105.4	108.4	162.4	161	1.4	8	3	
20	□	MNS0770X20DB	155.4	185.4	188.4	242.4	241	1.4	8	3	
30	□	MNS0770X30DB	232.4	265.4	268.4	322.4	321	1.4	8	3	
7.8	3	□	MNS0780S-DIN	29.7	41.4	42.4	79.4	78	1.4	8	4
	3	□	MNS0780S-DIN-C	29.7	41.4	42.4	79.4	78	1.4	8	3
	5	□	MNS0780L-DIN	41.7	53.4	54.4	91.4	90	1.4	8	4
	5	□	MNS0780L-DIN-C	41.7	53.4	54.4	91.4	90	1.4	8	3
	8	□	MNS0780-L8C	63.8	89.4	92.4	129.4	128	1.4	8	3
	10	□	MNS0780-L10C	79.4	105.4	108.4	145.4	144	1.4	8	3
	12	□	MNS0780-L12C	95.0	121.4	124.4	161.4	160	1.4	8	3
	15	□	MNS0780-L15C	118.4	145.4	148.4	185.4	184	1.4	8	3
	20	□	MNS0780-L20C	157.4	185.4	188.4	225.4	224	1.4	8	3
	25	□	MNS0780-L25C	196.4	225.4	228.4	265.4	264	1.4	8	3
	30	□	MNS0780-L30C	235.4	265.4	268.4	305.4	304	1.4	8	3
	5	★	MNS0780LB	40.4	65.4	65.4	119.4	118	1.4	8	3
10	★	MNS0780X10DB	79.4	105.4	108.4	162.4	161	1.4	8	3	
20	★	MNS0780X20DB	157.4	185.4	188.4	242.4	241	1.4	8	3	
30	★	MNS0780X30DB	235.4	265.4	268.4	322.4	321	1.4	8	3	

DC (mm)	Głębokość otworu (L/D)	TF15	Numer zamówieniowy	Wymiary (mm)							Typ
				LU	LCF	LH	OAL	LF	PL	DCON	
7.9	3	□	MNS0790S-DIN	29.6	41.4	42.4	79.4	78	1.4	8	4
	3	□	MNS0790S-DIN-C	29.6	41.4	42.4	79.4	78	1.4	8	3
	5	□	MNS0790L-DIN	41.6	53.4	54.4	91.4	90	1.4	8	4
	5	□	MNS0790L-DIN-C	41.6	53.4	54.4	91.4	90	1.4	8	3
	8	□	MNS0790-L8C	64.6	89.4	92.4	129.4	128	1.4	8	3
	10	□	MNS0790-L10C	80.4	105.4	108.4	145.4	144	1.4	8	3
	12	□	MNS0790-L12C	96.2	121.4	124.4	161.4	160	1.4	8	3
	15	□	MNS0790-L15C	119.9	145.4	148.4	185.4	184	1.4	8	3
	20	□	MNS0790-L20C	159.4	185.4	188.4	225.4	224	1.4	8	3
	25	□	MNS0790-L25C	198.9	225.4	228.4	265.4	264	1.4	8	3
	30	□	MNS0790-L30C	238.4	265.4	268.4	305.4	304	1.4	8	3
	5	★	MNS0790LB	40.9	65.4	65.4	119.4	118	1.4	8	3
10	□	MNS0790X10DB	80.4	105.4	108.4	162.4	161	1.4	8	3	
20	□	MNS0790X20DB	159.4	185.4	188.4	242.4	241	1.4	8	3	
30	□	MNS0790X30DB	238.4	265.4	268.4	322.4	321	1.4	8	3	
8.0	3	□	MNS0800S-DIN	29.5	41.5	42.5	79.5	78	1.5	8	4
	3	□	MNS0800S-DIN-C	29.5	41.5	42.5	79.5	78	1.5	8	3
	5	□	MNS0800L-DIN	41.5	53.5	54.5	91.5	90	1.5	8	4
	5	●	MNS0800L-DIN-C	41.5	53.5	54.5	91.5	90	1.5	8	3
	8	□	MNS0800-L8C	65.5	89.5	92.5	129.5	128	1.5	8	3
	10	□	MNS0800-L10C	81.5	105.5	108.5	145.5	144	1.5	8	3
	12	●	MNS0800-L12C	97.5	121.5	124.5	161.5	160	1.5	8	3
	15	□	MNS0800-L15C	121.5	145.5	148.5	185.5	184	1.5	8	3
	20	●	MNS0800-L20C	161.5	185.5	188.5	225.5	224	1.5	8	3
	25	□	MNS0800-L25C	201.5	225.5	228.5	265.5	264	1.5	8	3
	30	●	MNS0800-L30C	241.5	265.5	268.5	305.5	304	1.5	8	3
	5	★	MNS0800LB	41.5	65.5	65.5	119.5	118	1.5	8	3
10	★	MNS0800X10DB	81.5	105.5	108.5	162.5	161	1.5	8	3	
20	★	MNS0800X20DB	161.5	185.5	188.5	242.5	241	1.5	8	3	
30	★	MNS0800X30DB	241.5	265.5	268.5	322.5	321	1.5	8	3	
8.1	3	□	MNS0810S-DIN	34.3	46.5	47.5	88.5	87	1.5	10	4
	3	□	MNS0810S-DIN-C	34.3	46.5	47.5	88.5	87	1.5	10	3
	5	□	MNS0810L-DIN	48.3	60.5	61.5	102.5	101	1.5	10	4
	5	□	MNS0810L-DIN-C	48.3	60.5	61.5	102.5	101	1.5	10	3
	8	□	MNS0810-L8C	66.3	95.5	98.5	139.5	138	1.5	10	3
	10	□	MNS0810-L10C	82.5	112.5	115.5	156.5	155	1.5	10	3
	12	□	MNS0810-L12C	98.7	129.5	132.5	173.5	172	1.5	10	3
	15	□	MNS0810-L15C	123.0	154.5	157.5	198.5	197	1.5	10	3
	20	□	MNS0810-L20C	163.5	197.5	200.5	241.5	240	1.5	10	3
	25	□	MNS0810-L25C	204.0	239.5	242.5	283.5	282	1.5	10	3
	30	□	MNS0810-L30C	244.5	281.5	284.5	325.5	324	1.5	10	3
	5	★	MNS0810LB	42.0	69.5	73.5	128.5	127	1.5	9	3
10	□	MNS0810X10DB	82.5	112.5	115.5	170.5	169	1.5	9	3	
20	□	MNS0810X20DB	163.5	197.5	200.5	255.5	254	1.5	9	3	
30	□	MNS0810X30DB	244.5	282.5	285.5	340.5	339	1.5	9	3	

Uwaga 1) Gdy geometria wiertła nie odpowiada wartościom podanym w tabeli (np. inna średnica i długość wiertła), prosimy o skontaktowanie się z naszą firmą.

● : Standard magazynowy. ★ : Na specjalne zamówienie z magazynu w Japonii.

□ : Niestandardowy, produkowany na specjalne zamówienie.

DC (mm)	Głębokość otworu (L/D)	TF15	Numer zamówieniowy	Wymiary (mm)							Typ
				LU	LCF	LH	OAL	LF	PL	DCON	
8.2	3	□	MNS0820S-DIN	34.2	46.5	47.5	88.5	87	1.5	10	4
	3	□	MNS0820S-DIN-C	34.2	46.5	47.5	88.5	87	1.5	10	3
	5	□	MNS0820L-DIN	48.2	60.5	61.5	102.5	101	1.5	10	4
	5	□	MNS0820L-DIN-C	48.2	60.5	61.5	102.5	101	1.5	10	3
	8	□	MNS0820-L8C	67.1	95.5	98.5	139.5	138	1.5	10	3
	5	★	MNS0820LB	42.5	69.5	73.5	128.5	127	1.5	9	3
	10	□	MNS0820X10DB	83.5	112.5	115.5	170.5	169	1.5	9	3
	20	□	MNS0820X20DB	165.5	197.5	200.5	255.5	254	1.5	9	3
	30	□	MNS0820X30DB	247.5	282.5	285.5	340.5	339	1.5	9	3
8.3	3	□	MNS0830S-DIN	34.1	46.5	47.5	88.5	87	1.5	10	4
	3	□	MNS0830S-DIN-C	34.1	46.5	47.5	88.5	87	1.5	10	3
	5	□	MNS0830L-DIN-C	48.1	60.5	61.5	102.5	101	1.5	10	3
	8	□	MNS0830-L8C	67.9	95.5	98.5	139.5	138	1.5	10	3
	10	□	MNS0830-L10C	84.5	112.5	115.5	156.5	155	1.5	10	3
	12	□	MNS0830-L12C	101.1	129.5	132.5	173.5	172	1.5	10	3
	15	□	MNS0830-L15C	126.0	154.5	157.5	198.5	197	1.5	10	3
	20	□	MNS0830-L20C	167.5	197.5	200.5	241.5	240	1.5	10	3
	25	□	MNS0830-L25C	209.0	239.5	242.5	283.5	282	1.5	10	3
	30	□	MNS0830-L30C	250.5	281.5	284.5	325.5	324	1.5	10	3
	5	★	MNS0830LB	43.0	69.5	73.5	128.5	127	1.5	9	3
	10	□	MNS0830X10DB	84.5	112.5	115.5	170.5	169	1.5	9	3
	20	□	MNS0830X20DB	167.5	197.5	200.5	255.5	254	1.5	9	3
30	□	MNS0830X30DB	250.5	282.5	285.5	340.5	339	1.5	9	3	
8.4	3	□	MNS0840S-DIN	33.9	46.5	47.5	88.5	87	1.5	10	4
	3	□	MNS0840S-DIN-C	33.9	46.5	47.5	88.5	87	1.5	10	3
	5	□	MNS0840L-DIN	47.9	60.5	61.5	102.5	101	1.5	10	4
	5	□	MNS0840L-DIN-C	47.9	60.5	61.5	102.5	101	1.5	10	3
	8	□	MNS0840-L8C	68.7	95.5	98.5	139.5	138	1.5	10	3
	10	□	MNS0840-L10C	85.5	112.5	115.5	156.5	155	1.5	10	3
	12	□	MNS0840-L12C	102.3	129.5	132.5	173.5	172	1.5	10	3
	15	□	MNS0840-L15C	127.5	154.5	157.5	198.5	197	1.5	10	3
	20	□	MNS0840-L20C	169.5	197.5	200.5	241.5	240	1.5	10	3
	25	□	MNS0840-L25C	211.5	239.5	242.5	283.5	282	1.5	10	3
	30	□	MNS0840-L30C	253.5	281.5	284.5	325.5	324	1.5	10	3
	5	★	MNS0840LB	43.5	69.5	73.5	128.5	127	1.5	9	3
	10	□	MNS0840X10DB	85.5	112.5	115.5	170.5	169	1.5	9	3
20	□	MNS0840X20DB	169.5	197.5	200.5	255.5	254	1.5	9	3	
30	□	MNS0840X30DB	253.5	282.5	285.5	340.5	339	1.5	9	3	

DC (mm)	Głębokość otworu (L/D)	TF15	Numer zamówieniowy	Wymiary (mm)							Typ
				LU	LCF	LH	OAL	LF	PL	DCON	
8.5	3	□	MNS0850S-DIN	33.8	46.5	47.5	88.5	87	1.5	10	4
	3	□	MNS0850S-DIN-C	33.8	46.5	47.5	88.5	87	1.5	10	3
	5	□	MNS0850L-DIN	47.8	60.5	61.5	102.5	101	1.5	10	4
	5	●	MNS0850L-DIN-C	47.8	60.5	61.5	102.5	101	1.5	10	3
	8	□	MNS0850-L8C	69.5	95.5	98.5	139.5	138	1.5	10	3
	10	□	MNS0850-L10C	86.5	112.5	115.5	156.5	155	1.5	10	3
	12	●	MNS0850-L12C	103.5	129.5	132.5	173.5	172	1.5	10	3
	15	□	MNS0850-L15C	129.0	154.5	157.5	198.5	197	1.5	10	3
	20	●	MNS0850-L20C	171.5	197.5	200.5	241.5	240	1.5	10	3
	25	□	MNS0850-L25C	214.0	239.5	242.5	283.5	282	1.5	10	3
	30	●	MNS0850-L30C	256.5	281.5	284.5	325.5	324	1.5	10	3
	5	★	MNS0850LB	44.0	69.5	73.5	128.5	127	1.5	9	3
	10	□	MNS0850X10DB	86.5	112.5	115.5	170.5	169	1.5	9	3
20	□	MNS0850X20DB	171.5	197.5	200.5	255.5	254	1.5	9	3	
30	□	MNS0850X30DB	256.5	282.5	285.5	340.5	339	1.5	9	3	
8.6	3	□	MNS0860S-DIN	33.7	46.6	47.6	88.6	87	1.6	10	4
	3	□	MNS0860S-DIN-C	33.7	46.6	47.6	88.6	87	1.6	10	3
	5	□	MNS0860L-DIN-C	47.7	60.6	61.6	102.6	101	1.6	10	3
	8	□	MNS0860-L8C	70.4	100.6	103.6	144.6	143	1.6	10	3
	10	□	MNS0860-L10C	87.6	118.6	121.6	162.6	161	1.6	10	3
	12	□	MNS0860-L12C	104.8	136.6	139.6	180.6	179	1.6	10	3
	15	□	MNS0860-L15C	130.6	163.6	166.6	207.6	206	1.6	10	3
	20	□	MNS0860-L20C	173.6	208.6	211.6	252.6	251	1.6	10	3
	25	□	MNS0860-L25C	216.6	253.6	256.6	297.6	296	1.6	10	3
	30	□	MNS0860-L30C	259.6	297.6	300.6	341.6	340	1.6	10	3
	5	★	MNS0860LB	44.6	73.6	73.6	128.6	127	1.6	9	3
	10	□	MNS0860X10DB	87.6	118.6	121.6	176.6	175	1.6	9	3
	20	□	MNS0860X20DB	173.6	208.6	211.6	266.6	265	1.6	9	3
30	□	MNS0860X30DB	259.6	298.6	301.6	356.6	355	1.6	9	3	
8.7	3	□	MNS0870S-DIN	33.5	46.6	47.6	88.6	87	1.6	10	4
	3	□	MNS0870S-DIN-C	33.5	46.6	47.6	88.6	87	1.6	10	3
	5	□	MNS0870L-DIN	47.5	60.6	61.6	102.6	101	1.6	10	4
	5	□	MNS0870L-DIN-C	47.5	60.6	61.6	102.6	101	1.6	10	3
	8	□	MNS0870-L8C	71.2	100.6	103.6	144.6	143	1.6	10	3
	10	□	MNS0870-L10C	88.6	118.6	121.6	162.6	161	1.6	10	3
	12	□	MNS0870-L12C	106.0	136.6	139.6	180.6	179	1.6	10	3
	15	□	MNS0870-L15C	132.1	163.6	166.6	207.6	206	1.6	10	3
	20	□	MNS0870-L20C	175.6	208.6	211.6	252.6	251	1.6	10	3
	25	□	MNS0870-L25C	219.1	253.6	256.6	297.6	296	1.6	10	3
	30	□	MNS0870-L30C	262.6	297.6	300.6	341.6	340	1.6	10	3
	5	★	MNS0870LB	45.1	73.6	73.6	128.6	127	1.6	9	3
	10	□	MNS0870X10DB	88.6	118.6	121.6	176.6	175	1.6	9	3
20	□	MNS0870X20DB	175.6	208.6	211.6	266.6	265	1.6	9	3	
30	□	MNS0870X30DB	262.6	298.6	301.6	356.6	355	1.6	9	3	

DC (mm)	Głębokość otworu (L/D)	TF15	Numer zamówieniowy	Wymiary (mm)							Typ
				LU	LCF	LH	OAL	LF	PL	DCON	
8.8	3	□	MNS0880S-DIN	33.4	46.6	47.6	88.6	87	1.6	10	4
	3	□	MNS0880S-DIN-C	33.4	46.6	47.6	88.6	87	1.6	10	3
	5	□	MNS0880L-DIN	47.4	60.6	61.6	102.6	101	1.6	10	4
	5	□	MNS0880L-DIN-C	47.4	60.6	61.6	102.6	101	1.6	10	3
	8	□	MNS0880-L8C	72.0	100.6	103.6	144.6	143	1.6	10	3
	10	□	MNS0880-L10C	89.6	118.6	121.6	162.6	161	1.6	10	3
	12	□	MNS0880-L12C	107.2	136.6	139.6	180.6	179	1.6	10	3
	15	□	MNS0880-L15C	133.6	163.6	166.6	207.6	206	1.6	10	3
	20	□	MNS0880-L20C	177.6	208.6	211.6	252.6	251	1.6	10	3
	25	□	MNS0880-L25C	221.6	253.6	256.6	297.6	296	1.6	10	3
	30	□	MNS0880-L30C	265.6	297.6	300.6	341.6	340	1.6	10	3
	5	★	MNS0880LB	45.6	73.6	73.6	128.6	127	1.6	9	3
	10	□	MNS0880X10DB	89.6	118.6	121.6	176.6	175	1.6	9	3
	20	□	MNS0880X20DB	177.6	208.6	211.6	266.6	265	1.6	9	3
	30	□	MNS0880X30DB	265.6	298.6	301.6	356.6	355	1.6	9	3
8.9	3	□	MNS0890S-DIN	33.3	46.6	47.6	88.6	87	1.6	10	4
	3	□	MNS0890S-DIN-C	33.3	46.6	47.6	88.6	87	1.6	10	3
	5	□	MNS0890L-DIN	47.3	60.6	61.6	102.6	101	1.6	10	4
	5	□	MNS0890L-DIN-C	47.3	60.6	61.6	102.6	101	1.6	10	3
	8	□	MNS0890-L8C	72.8	100.6	103.6	144.6	143	1.6	10	3
	10	□	MNS0890-L10C	90.6	118.6	121.6	162.6	161	1.6	10	3
	12	□	MNS0890-L12C	108.4	136.6	139.6	180.6	179	1.6	10	3
	15	□	MNS0890-L15C	135.1	163.6	166.6	207.6	206	1.6	10	3
	20	□	MNS0890-L20C	179.6	208.6	211.6	252.6	251	1.6	10	3
	25	□	MNS0890-L25C	224.1	253.6	256.6	297.6	296	1.6	10	3
	30	□	MNS0890-L30C	268.6	297.6	300.6	341.6	340	1.6	10	3
	5	★	MNS0890LB	46.1	73.6	73.6	128.6	127	1.6	9	3
	10	□	MNS0890X10DB	90.6	118.6	121.6	176.6	175	1.6	9	3
	20	□	MNS0890X20DB	179.6	208.6	211.6	266.6	265	1.6	9	3
	30	□	MNS0890X30DB	268.6	298.6	301.6	356.6	355	1.6	9	3
9.0	3	□	MNS0900S-DIN	33.1	46.6	47.6	88.6	87	1.6	10	4
	3	□	MNS0900S-DIN-C	33.1	46.6	47.6	88.6	87	1.6	10	3
	5	□	MNS0900L-DIN	47.1	60.6	61.6	102.6	101	1.6	10	4
	5	●	MNS0900L-DIN-C	47.1	60.6	61.6	102.6	101	1.6	10	3
	8	□	MNS0900-L8C	73.6	100.6	103.6	144.6	143	1.6	10	3
	10	□	MNS0900-L10C	91.6	118.6	121.6	162.6	161	1.6	10	3
	12	●	MNS0900-L12C	109.6	136.6	139.6	180.6	179	1.6	10	3
	15	□	MNS0900-L15C	136.6	163.6	166.6	207.6	206	1.6	10	3
	20	●	MNS0900-L20C	181.6	208.6	211.6	252.6	251	1.6	10	3
	25	□	MNS0900-L25C	226.6	253.6	256.6	297.6	296	1.6	10	3
	30	●	MNS0900-L30C	271.6	297.6	300.6	341.6	340	1.6	10	3
	5	★	MNS0900LB	46.6	73.6	73.6	128.6	127	1.6	9	3
	10	★	MNS0900X10DB	91.6	118.6	121.6	176.6	175	1.6	9	3
	20	★	MNS0900X20DB	181.6	208.6	211.6	266.6	265	1.6	9	3
	30	★	MNS0900X30DB	271.6	298.6	301.6	356.6	355	1.6	9	3

DC (mm)	Głębokość otworu (L/D)	TF15	Numer zamówieniowy	Wymiary (mm)							Typ
				LU	LCF	LH	OAL	LF	PL	DCON	
9.1	3	□	MNS0910S-DIN	33.0	46.7	47.7	88.7	87	1.7	10	4
	3	□	MNS0910S-DIN-C	33.0	46.7	47.7	88.7	87	1.7	10	3
	5	□	MNS0910L-DIN	47.0	60.7	61.7	102.7	101	1.7	10	4
	5	□	MNS0910L-DIN-C	47.0	60.7	61.7	102.7	101	1.7	10	3
	8	□	MNS0910-L8C	74.5	106.7	109.7	150.7	149	1.7	10	3
	10	□	MNS0910-L10C	92.7	125.7	128.7	169.7	168	1.7	10	3
	12	□	MNS0910-L12C	110.9	144.7	147.7	188.7	187	1.7	10	3
	15	□	MNS0910-L15C	138.2	172.7	175.7	216.7	215	1.7	10	3
	20	□	MNS0910-L20C	183.7	220.7	223.7	264.7	263	1.7	10	3
	25	□	MNS0910-L25C	229.2	267.7	270.7	311.7	310	1.7	10	3
	30	□	MNS0910-L30C	274.7	315.7	318.7	359.7	358	1.7	10	3
	5	★	MNS0910LB	47.2	77.7	81.7	137.7	136	1.7	10	3
	10	□	MNS0910X10DB	92.7	125.7	128.7	183.7	182	1.7	10	3
	20	□	MNS0910X20DB	183.7	220.7	223.7	278.7	277	1.7	10	3
	30	□	MNS0910X30DB	274.7	315.7	318.7	373.7	372	1.7	10	3
9.2	3	□	MNS0920S-DIN	32.9	46.7	47.7	88.7	87	1.7	10	4
	3	□	MNS0920S-DIN-C	32.9	46.7	47.7	88.7	87	1.7	10	3
	5	□	MNS0920L-DIN	46.9	60.7	61.7	102.7	101	1.7	10	4
	5	□	MNS0920L-DIN-C	46.9	60.7	61.7	102.7	101	1.7	10	3
	8	□	MNS0920-L8C	75.3	106.7	109.7	150.7	149	1.7	10	3
	10	□	MNS0920-L10C	93.7	125.7	128.7	169.7	168	1.7	10	3
	12	□	MNS0920-L12C	112.1	144.7	147.7	188.7	187	1.7	10	3
	15	□	MNS0920-L15C	139.7	172.7	175.7	216.7	215	1.7	10	3
	20	□	MNS0920-L20C	185.7	220.7	223.7	264.7	263	1.7	10	3
	25	□	MNS0920-L25C	231.7	267.7	270.7	311.7	310	1.7	10	3
	30	□	MNS0920-L30C	277.7	315.7	318.7	359.7	358	1.7	10	3
	5	★	MNS0920LB	47.7	77.7	81.7	137.7	136	1.7	10	3
	10	□	MNS0920X10DB	93.7	125.7	128.7	183.7	182	1.7	10	3
	20	□	MNS0920X20DB	185.7	220.7	223.7	278.7	277	1.7	10	3
	30	□	MNS0920X30DB	277.7	315.7	318.7	373.7	372	1.7	10	3
9.3	3	□	MNS0930S-DIN	32.7	46.7	47.7	88.7	87	1.7	10	4
	3	□	MNS0930S-DIN-C	32.7	46.7	47.7	88.7	87	1.7	10	3
	5	□	MNS0930L-DIN	46.7	60.7	61.7	102.7	101	1.7	10	4
	5	□	MNS0930L-DIN-C	46.7	60.7	61.7	102.7	101	1.7	10	3
	8	□	MNS0930-L8C	76.1	106.7	109.7	150.7	149	1.7	10	3
	10	□	MNS0930-L10C	94.7	125.7	128.7	169.7	168	1.7	10	3
	12	□	MNS0930-L12C	113.3	144.7	147.7	188.7	187	1.7	10	3
	15	□	MNS0930-L15C	141.2	172.7	175.7	216.7	215	1.7	10	3
	20	□	MNS0930-L20C	187.7	220.7	223.7	264.7	263	1.7	10	3
	25	□	MNS0930-L25C	234.2	267.7	270.7	311.7	310	1.7	10	3
	30	□	MNS0930-L30C	280.7	315.7	318.7	359.7	358	1.7	10	3
	5	★	MNS0930LB	48.2	77.7	81.7	137.7	136	1.7	10	3
	10	□	MNS0930X10DB	94.7	125.7	128.7	183.7	182	1.7	10	3
	20	□	MNS0930X20DB	187.7	220.7	223.7	278.7	277	1.7	10	3
	30	□	MNS0930X30DB	280.7	315.7	318.7	373.7	372	1.7	10	3

Uwaga 1) Gdy geometria wiertła nie odpowiada wartościom podanym w tabeli (np. inna średnica i długość wiertła), prosimy o skontaktowanie się z naszą firmą.

● : Standard magazynowy. ★ : Na specjalne zamówienie z magazynu w Japonii.

□ : Niestandardowy, produkowany na specjalne zamówienie.

DC (mm)	Głębokość otworu (L/D)	TF15	Numer zamówieniowy	Wymiary (mm)							Typ
				LU	LCF	LH	OAL	LF	PL	DCON	
9.4	3	□	MNS0940S-DIN	32.6	46.7	47.7	88.7	87	1.7	10	4
	3	□	MNS0940S-DIN-C	32.6	46.7	47.7	88.7	87	1.7	10	3
	5	□	MNS0940L-DIN	46.6	60.7	61.7	102.7	101	1.7	10	4
	5	□	MNS0940L-DIN-C	46.6	60.7	61.7	102.7	101	1.7	10	3
	8	□	MNS0940-L8C	76.9	106.7	109.7	150.7	149	1.7	10	3
	10	□	MNS0940-L10C	95.7	125.7	128.7	169.7	168	1.7	10	3
	12	□	MNS0940-L12C	114.5	144.7	147.7	188.7	187	1.7	10	3
	15	□	MNS0940-L15C	142.7	172.7	175.7	216.7	215	1.7	10	3
	20	□	MNS0940-L20C	189.7	220.7	223.7	264.7	263	1.7	10	3
	25	□	MNS0940-L25C	236.7	267.7	270.7	311.7	310	1.7	10	3
	30	□	MNS0940-L30C	283.7	315.7	318.7	359.7	358	1.7	10	3
	5	★	MNS0940LB	48.7	77.7	81.7	137.7	136	1.7	10	3
	10	□	MNS0940X10DB	95.7	125.7	128.7	183.7	182	1.7	10	3
	20	□	MNS0940X20DB	189.7	220.7	223.7	278.7	277	1.7	10	3
	30	□	MNS0940X30DB	283.7	315.7	318.7	373.7	372	1.7	10	3
9.5	3	□	MNS0950S-DIN	32.5	46.7	47.7	88.7	87	1.7	10	4
	3	□	MNS0950S-DIN-C	32.5	46.7	47.7	88.7	87	1.7	10	3
	5	□	MNS0950L-DIN	46.5	60.7	61.7	102.7	101	1.7	10	4
	5	●	MNS0950L-DIN-C	46.5	60.7	61.7	102.7	101	1.7	10	3
	8	□	MNS0950-L8C	77.7	106.7	109.7	150.7	149	1.7	10	3
	10	□	MNS0950-L10C	96.7	125.7	128.7	169.7	168	1.7	10	3
	12	●	MNS0950-L12C	115.7	144.7	147.7	188.7	187	1.7	10	3
	15	□	MNS0950-L15C	144.2	172.7	175.7	216.7	215	1.7	10	3
	20	●	MNS0950-L20C	191.7	220.7	223.7	264.7	263	1.7	10	3
	25	□	MNS0950-L25C	239.2	267.7	270.7	311.7	310	1.7	10	3
	30	●	MNS0950-L30C	286.7	315.7	318.7	359.7	358	1.7	10	3
	5	★	MNS0950LB	49.2	77.7	81.7	137.7	136	1.7	10	3
	10	□	MNS0950X10DB	96.7	125.7	128.7	183.7	182	1.7	10	3
	20	□	MNS0950X20DB	191.7	220.7	223.7	278.7	277	1.7	10	3
	30	□	MNS0950X30DB	286.7	315.7	318.7	373.7	372	1.7	10	3
9.6	3	□	MNS0960S-DIN	32.3	46.7	47.7	88.7	87	1.7	10	4
	3	□	MNS0960S-DIN-C	32.3	46.7	47.7	88.7	87	1.7	10	3
	5	□	MNS0960L-DIN	46.3	60.7	61.7	102.7	101	1.7	10	4
	5	□	MNS0960L-DIN-C	46.3	60.7	61.7	102.7	101	1.7	10	3
	8	□	MNS0960-L8C	78.5	111.7	114.7	155.7	154	1.7	10	3
	10	□	MNS0960-L10C	97.7	131.7	134.7	175.7	174	1.7	10	3
	12	□	MNS0960-L12C	116.9	151.7	154.7	195.7	194	1.7	10	3
	15	□	MNS0960-L15C	145.7	181.7	184.7	225.7	224	1.7	10	3
	20	□	MNS0960-L20C	193.7	231.7	234.7	275.7	274	1.7	10	3
	25	□	MNS0960-L25C	241.7	281.7	284.7	325.7	324	1.7	10	3
	30	□	MNS0960-L30C	289.7	331.7	334.7	375.7	374	1.7	10	3
	5	★	MNS0960LB	49.7	81.7	81.7	137.7	136	1.7	10	3
	10	□	MNS0960X10DB	97.7	131.7	134.7	189.7	188	1.7	10	3
	20	□	MNS0960X20DB	193.7	231.7	234.7	289.7	288	1.7	10	3
	30	□	MNS0960X30DB	289.7	331.7	334.7	389.7	388	1.7	10	3

DC (mm)	Głębokość otworu (L/D)	TF15	Numer zamówieniowy	Wymiary (mm)							Typ
				LU	LCF	LH	OAL	LF	PL	DCON	
9.7	3	□	MNS0970S-DIN	32.2	46.8	47.8	88.8	87	1.8	10	4
	3	□	MNS0970S-DIN-C	32.2	46.8	47.8	88.8	87	1.8	10	3
	5	□	MNS0970L-DIN	46.2	60.8	61.8	102.8	101	1.8	10	4
	5	□	MNS0970L-DIN-C	46.2	60.8	61.8	102.8	101	1.8	10	3
	8	□	MNS0970-L8C	79.4	111.8	114.8	155.8	154	1.8	10	3
	10	□	MNS0970-L10C	98.8	131.8	134.8	175.8	174	1.8	10	3
	12	□	MNS0970-L12C	118.2	151.8	154.8	195.8	194	1.8	10	3
	15	□	MNS0970-L15C	147.3	181.8	184.8	225.8	224	1.8	10	3
	20	□	MNS0970-L20C	195.8	231.8	234.8	275.8	274	1.8	10	3
	25	□	MNS0970-L25C	244.3	281.8	284.8	325.8	324	1.8	10	3
	30	□	MNS0970-L30C	292.8	331.8	334.8	375.8	374	1.8	10	3
	5	★	MNS0970LB	50.3	81.8	81.8	137.8	136	1.8	10	3
	10	□	MNS0970X10DB	98.8	131.8	134.8	189.8	188	1.8	10	3
	20	□	MNS0970X20DB	195.8	231.8	234.8	289.8	288	1.8	10	3
	30	□	MNS0970X30DB	292.8	331.8	334.8	389.8	388	1.8	10	3
9.8	3	□	MNS0980S-DIN	32.1	46.8	47.8	88.8	87	1.8	10	4
	3	□	MNS0980S-DIN-C	32.1	46.8	47.8	88.8	87	1.8	10	3
	5	□	MNS0980L-DIN	46.1	60.8	61.8	102.8	101	1.8	10	4
	5	□	MNS0980L-DIN-C	46.1	60.8	61.8	102.8	101	1.8	10	3
	8	□	MNS0980-L8C	80.2	111.8	114.8	155.8	154	1.8	10	3
	10	□	MNS0980-L10C	99.8	131.8	134.8	175.8	174	1.8	10	3
	12	□	MNS0980-L12C	119.4	151.8	154.8	195.8	194	1.8	10	3
	15	□	MNS0980-L15C	148.8	181.8	184.8	225.8	224	1.8	10	3
	20	□	MNS0980-L20C	197.8	231.8	234.8	275.8	274	1.8	10	3
	25	□	MNS0980-L25C	246.8	281.8	284.8	325.8	324	1.8	10	3
	30	□	MNS0980-L30C	295.8	331.8	334.8	375.8	374	1.8	10	3
	5	★	MNS0980LB	50.8	81.8	81.8	137.8	136	1.8	10	3
	10	★	MNS0980X10DB	99.8	131.8	134.8	189.8	188	1.8	10	3
	20	★	MNS0980X20DB	197.8	231.8	234.8	289.8	288	1.8	10	3
	30	★	MNS0980X30DB	295.8	331.8	334.8	389.8	388	1.8	10	3
9.9	3	□	MNS0990S-DIN	32.0	46.8	47.8	88.8	87	1.8	10	4
	3	□	MNS0990S-DIN-C	32.0	46.8	47.8	88.8	87	1.8	10	3
	5	□	MNS0990L-DIN	46.0	60.8	61.8	102.8	101	1.8	10	4
	5	□	MNS0990L-DIN-C	46.0	60.8	61.8	102.8	101	1.8	10	3
	8	□	MNS0990-L8C	81.0	111.8	114.8	155.8	154	1.8	10	3
	10	□	MNS0990-L10C	100.8	131.8	134.8	175.8	174	1.8	10	3
	12	□	MNS0990-L12C	120.6	151.8	154.8	195.8	194	1.8	10	3
	15	□	MNS0990-L15C	150.3	181.8	184.8	225.8	224	1.8	10	3
	20	□	MNS0990-L20C	199.8	231.8	234.8	275.8	274	1.8	10	3
	25	□	MNS0990-L25C	249.3	281.8	284.8	325.8	324	1.8	10	3
	30	□	MNS0990-L30C	298.8	331.8	334.8	375.8	374	1.8	10	3
	5	★	MNS0990LB	51.3	81.8	81.8	137.8	136	1.8	10	3
	10	□	MNS0990X10DB	100.8	131.8	134.8	189.8	188	1.8	10	3
	20	□	MNS0990X20DB	199.8	231.8	234.8	289.8	288	1.8	10	3
	30	□	MNS0990X30DB	298.8	331.8	334.8	389.8	388	1.8	10	3

DC (mm)	Głębokość otworu (L/D)	TF15	Numer zamówieniowy	Wymiary (mm)							Typ
				LU	LCF	LH	OAL	LF	PL	DCON	
10.0	3	□	MNS1000S-DIN	31.8	46.8	47.8	88.8	87	1.8	10	4
	3	□	MNS1000S-DIN-C	31.8	46.8	47.8	88.8	87	1.8	10	3
	5	□	MNS1000L-DIN	45.8	60.8	61.8	102.8	101	1.8	10	4
	5	●	MNS1000L-DIN-C	45.8	60.8	61.8	102.8	101	1.8	10	3
	8	□	MNS1000-L8C	81.8	111.8	114.8	155.8	154	1.8	10	3
	10	□	MNS1000-L10C	101.8	131.8	134.8	175.8	174	1.8	10	3
	12	●	MNS1000-L12C	121.8	151.8	154.8	195.8	194	1.8	10	3
	15	□	MNS1000-L15C	151.8	181.8	184.8	225.8	224	1.8	10	3
	20	●	MNS1000-L20C	201.8	231.8	234.8	275.8	274	1.8	10	3
	25	□	MNS1000-L25C	251.8	281.8	284.8	325.8	324	1.8	10	3
	30	●	MNS1000-L30C	301.8	331.8	334.8	375.8	374	1.8	10	3
	5	★	MNS1000LB	51.8	81.8	81.8	137.8	136	1.8	10	3
	10	★	MNS1000X10DB	101.8	131.8	134.8	189.8	188	1.8	10	3
	20	★	MNS1000X20DB	201.8	231.8	234.8	289.8	288	1.8	10	3
30	★	MNS1000X30DB	301.8	331.8	334.8	389.8	388	1.8	10	3	
10.1	3	□	MNS1010S-DIN	39.7	54.8	55.8	101.8	100	1.8	12	4
	3	□	MNS1010S-DIN-C	39.7	54.8	55.8	101.8	100	1.8	12	3
	5	□	MNS1010L-DIN	55.7	70.8	71.8	117.8	116	1.8	12	4
	5	□	MNS1010L-DIN-C	55.7	70.8	71.8	117.8	116	1.8	12	3
	8	□	MNS1010-L8C	82.6	117.8	120.8	166.8	165	1.8	12	3
	10	□	MNS1010-L10C	102.8	138.8	141.8	187.8	186	1.8	12	3
	12	□	MNS1010-L12C	123.0	159.8	162.8	208.8	207	1.8	12	3
	15	□	MNS1010-L15C	153.3	190.8	193.8	239.8	238	1.8	12	3
	20	□	MNS1010-L20C	203.8	243.8	246.8	292.8	291	1.8	12	3
	25	□	MNS1010-L25C	254.3	295.8	298.8	344.8	343	1.8	12	3
	5	★	MNS1010LB	52.3	85.8	89.8	150.8	149	1.8	11	3
	10	□	MNS1010X10DB	102.8	138.8	141.8	202.8	201	1.8	11	3
	20	□	MNS1010X20DB	203.8	243.8	246.8	307.8	306	1.8	11	3
	10.2	3	□	MNS1020S-DIN	39.6	54.9	55.9	101.9	100	1.9	12
3		□	MNS1020S-DIN-C	39.6	54.9	55.9	101.9	100	1.9	12	3
5		□	MNS1020L-DIN	55.6	70.9	71.9	117.9	116	1.9	12	4
5		□	MNS1020L-DIN-C	55.6	70.9	71.9	117.9	116	1.9	12	3
8		□	MNS1020-L8C	83.5	117.9	120.9	166.9	165	1.9	12	3
10		□	MNS1020-L10C	103.9	138.9	141.9	187.9	186	1.9	12	3
12		□	MNS1020-L12C	124.3	159.9	162.9	208.9	207	1.9	12	3
15		□	MNS1020-L15C	154.9	190.9	193.9	239.9	238	1.9	12	3
20		□	MNS1020-L20C	205.9	243.9	246.9	292.9	291	1.9	12	3
25		□	MNS1020-L25C	256.9	295.9	298.9	344.9	343	1.9	12	3
5		★	MNS1020LB	52.9	85.9	89.9	150.9	149	1.9	11	3
10		□	MNS1020X10DB	103.9	138.9	141.9	202.9	201	1.9	11	3
20		□	MNS1020X20DB	205.9	243.9	246.9	307.9	306	1.9	11	3
10.3		3	□	MNS1030S-DIN	39.4	54.9	55.9	101.9	100	1.9	12
	3	□	MNS1030S-DIN-C	39.4	54.9	55.9	101.9	100	1.9	12	3
	5	□	MNS1030L-DIN	55.4	70.9	71.9	117.9	116	1.9	12	4
	5	□	MNS1030L-DIN-C	55.4	70.9	71.9	117.9	116	1.9	12	3
	8	□	MNS1030-L8C	84.3	117.9	120.9	166.9	165	1.9	12	3
	10	□	MNS1030-L10C	104.9	138.9	141.9	187.9	186	1.9	12	3
	12	□	MNS1030-L12C	125.5	159.9	162.9	208.9	207	1.9	12	3

DC (mm)	Głębokość otworu (L/D)	TF15	Numer zamówieniowy	Wymiary (mm)							Typ
				LU	LCF	LH	OAL	LF	PL	DCON	
10.3	15	□	MNS1030-L15C	156.4	190.9	193.9	239.9	238	1.9	12	3
	20	□	MNS1030-L20C	207.9	243.9	246.9	292.9	291	1.9	12	3
	25	□	MNS1030-L25C	259.4	295.9	298.9	344.9	343	1.9	12	3
	5	★	MNS1030LB	53.4	85.9	89.9	150.9	149	1.9	11	3
	10	□	MNS1030X10DB	104.9	138.9	141.9	202.9	201	1.9	11	3
	20	□	MNS1030X20DB	207.9	243.9	246.9	307.9	306	1.9	11	3
10.4	3	□	MNS1040S-DIN	39.3	54.9	55.9	101.9	100	1.9	12	4
	3	□	MNS1040S-DIN-C	39.3	54.9	55.9	101.9	100	1.9	12	3
	5	□	MNS1040L-DIN	55.3	70.9	71.9	117.9	116	1.9	12	4
	5	□	MNS1040L-DIN-C	55.3	70.9	71.9	117.9	116	1.9	12	3
	8	□	MNS1040-L8C	85.1	117.9	120.9	166.9	165	1.9	12	3
	10	□	MNS1040-L10C	105.9	138.9	141.9	187.9	186	1.9	12	3
	12	□	MNS1040-L12C	126.7	159.9	162.9	208.9	207	1.9	12	3
	15	□	MNS1040-L15C	157.9	190.9	193.9	239.9	238	1.9	12	3
	20	□	MNS1040-L20C	209.9	243.9	246.9	292.9	291	1.9	12	3
	25	□	MNS1040-L25C	261.9	295.9	298.9	344.9	343	1.9	12	3
5	★	MNS1040LB	53.9	85.9	89.9	150.9	149	1.9	11	3	
10	□	MNS1040X10DB	105.9	138.9	141.9	202.9	201	1.9	11	3	
20	□	MNS1040X20DB	209.9	243.9	246.9	307.9	306	1.9	11	3	
10.5	3	□	MNS1050S-DIN	39.2	54.9	55.9	101.9	100	1.9	12	4
	3	□	MNS1050S-DIN-C	39.2	54.9	55.9	101.9	100	1.9	12	3
	5	□	MNS1050L-DIN	55.2	70.9	71.9	117.9	116	1.9	12	4
	5	●	MNS1050L-DIN-C	55.2	70.9	71.9	117.9	116	1.9	12	3
	8	□	MNS1050-L8C	85.9	117.9	120.9	166.9	165	1.9	12	3
	10	□	MNS1050-L10C	106.9	138.9	141.9	187.9	186	1.9	12	3
	12	●	MNS1050-L12C	127.9	159.9	162.9	208.9	207	1.9	12	3
	15	□	MNS1050-L15C	159.4	190.9	193.9	239.9	238	1.9	12	3
	20	●	MNS1050-L20C	211.9	243.9	246.9	292.9	291	1.9	12	3
	25	□	MNS1050-L25C	264.4	295.9	298.9	344.9	343	1.9	12	3
5	★	MNS1050LB	54.4	85.9	89.9	150.9	149	1.9	11	3	
10	★	MNS1050X10DB	106.9	138.9	141.9	202.9	201	1.9	11	3	
20	★	MNS1050X20DB	211.9	243.9	246.9	307.9	306	1.9	11	3	
10.6	3	□	MNS1060S-DIN	39.0	54.9	55.9	101.9	100	1.9	12	4
	3	□	MNS1060S-DIN-C	39.0	54.9	55.9	101.9	100	1.9	12	3
	5	□	MNS1060L-DIN	55.0	70.9	71.9	117.9	116	1.9	12	4
	5	□	MNS1060L-DIN-C	55.0	70.9	71.9	117.9	116	1.9	12	3
	8	□	MNS1060-L8C	86.7	122.9	125.9	171.9	170	1.9	12	3
	10	□	MNS1060-L10C	107.9	144.9	147.9	193.9	192	1.9	12	3
	12	□	MNS1060-L12C	129.1	166.9	169.9	215.9	214	1.9	12	3
	15	□	MNS1060-L15C	160.9	199.9	202.9	248.9	247	1.9	12	3
	20	□	MNS1060-L20C	213.9	254.9	257.9	303.9	302	1.9	12	3
	25	□	MNS1060-L25C	266.9	309.9	312.9	358.9	357	1.9	12	3
5	★	MNS1060LB	54.9	89.9	89.9	150.9	149	1.9	11	3	
10	□	MNS1060X10DB	107.9	144.9	147.9	208.9	207	1.9	11	3	
20	□	MNS1060X20DB	213.9	254.9	257.9	318.9	317	1.9	11	3	

Uwaga 1) Gdy geometria wiertła nie odpowiada wartościom podanym w tabeli (np. inna średnica i długość wiertła), prosimy o skontaktowanie się z naszą firmą.

● : Standard magazynowy. ★ : Na specjalne zamówienie z magazynu w Japonii.

□ : Niestandardowy, produkowany na specjalne zamówienie.

DC (mm)	Głębokość otworu (L/D)	TF15	Numer zamówieniowy	Wymiary (mm)							Typ
				LU	LCF	LH	OAL	LF	PL	DCON	
10.7	3	□	MNS1070S-DIN	38.9	54.9	55.9	101.9	100	1.9	12	4
	3	□	MNS1070S-DIN-C	38.9	54.9	55.9	101.9	100	1.9	12	3
	5	□	MNS1070L-DIN	54.9	70.9	71.9	117.9	116	1.9	12	4
	5	□	MNS1070L-DIN-C	54.9	70.9	71.9	117.9	116	1.9	12	3
	8	□	MNS1070-L8C	87.5	122.9	125.9	171.9	170	1.9	12	3
	10	□	MNS1070-L10C	108.9	144.9	147.9	193.9	192	1.9	12	3
	12	□	MNS1070-L12C	130.3	166.9	169.9	215.9	214	1.9	12	3
	15	□	MNS1070-L15C	162.4	199.9	202.9	248.9	247	1.9	12	3
	20	□	MNS1070-L20C	215.9	254.9	257.9	303.9	302	1.9	12	3
	25	□	MNS1070-L25C	269.4	309.9	312.9	358.9	357	1.9	12	3
	5	★	MNS1070LB	55.4	89.9	89.9	150.9	149	1.9	11	3
	10	□	MNS1070X10DB	108.9	144.9	147.9	208.9	207	1.9	11	3
20	□	MNS1070X20DB	215.9	254.9	257.9	318.9	317	1.9	11	3	
10.8	3	□	MNS1080S-DIN	38.8	55.0	56.0	102.0	100	2.0	12	4
	3	□	MNS1080S-DIN-C	38.8	55.0	56.0	102.0	100	2.0	12	3
	5	□	MNS1080L-DIN	54.8	71.0	72.0	118.0	116	2.0	12	4
	5	□	MNS1080L-DIN-C	54.8	71.0	72.0	118.0	116	2.0	12	3
	8	□	MNS1080-L8C	88.4	123.0	126.0	172.0	170	2.0	12	3
	10	□	MNS1080-L10C	110.0	145.0	148.0	194.0	192	2.0	12	3
	12	□	MNS1080-L12C	131.6	167.0	170.0	216.0	214	2.0	12	3
	15	□	MNS1080-L15C	164.0	200.0	203.0	249.0	247	2.0	12	3
	20	□	MNS1080-L20C	218.0	255.0	258.0	304.0	302	2.0	12	3
	25	□	MNS1080-L25C	272.0	310.0	313.0	359.0	357	2.0	12	3
	5	★	MNS1080LB	56.0	90.0	90.0	151.0	149	2.0	11	3
	10	□	MNS1080X10DB	110.0	145.0	148.0	209.0	207	2.0	11	3
20	□	MNS1080X20DB	218.0	255.0	258.0	319.0	317	2.0	11	3	
10.9	3	□	MNS1090S-DIN	38.6	55.0	56.0	102.0	100	2.0	12	4
	3	□	MNS1090S-DIN-C	38.6	55.0	56.0	102.0	100	2.0	12	3
	5	□	MNS1090L-DIN	54.6	71.0	72.0	118.0	116	2.0	12	4
	5	□	MNS1090L-DIN-C	54.6	71.0	72.0	118.0	116	2.0	12	3
	8	□	MNS1090-L8C	89.2	123.0	126.0	172.0	170	2.0	12	3
	10	□	MNS1090-L10C	111.0	145.0	148.0	194.0	192	2.0	12	3
	12	□	MNS1090-L12C	132.8	167.0	170.0	216.0	214	2.0	12	3
	15	□	MNS1090-L15C	165.5	200.0	203.0	249.0	247	2.0	12	3
	20	□	MNS1090-L20C	220.0	255.0	258.0	304.0	302	2.0	12	3
	25	□	MNS1090-L25C	274.5	310.0	313.0	359.0	357	2.0	12	3
	5	★	MNS1090LB	56.5	90.0	90.0	151.0	149	2.0	11	3
	10	□	MNS1090X10DB	111.0	145.0	148.0	209.0	207	2.0	11	3
20	□	MNS1090X20DB	220.0	255.0	258.0	319.0	317	2.0	11	3	
11.0	3	□	MNS1100S-DIN	38.5	55.0	56.0	102.0	100	2.0	12	4
	3	□	MNS1100S-DIN-C	38.5	55.0	56.0	102.0	100	2.0	12	3
	5	□	MNS1100L-DIN	54.5	71.0	72.0	118.0	116	2.0	12	4
	5	●	MNS1100L-DIN-C	54.5	71.0	72.0	118.0	116	2.0	12	3
	8	□	MNS1100-L8C	90.0	123.0	126.0	172.0	170	2.0	12	3
	10	□	MNS1100-L10C	112.0	145.0	148.0	194.0	192	2.0	12	3
	12	●	MNS1100-L12C	134.0	167.0	170.0	216.0	214	2.0	12	3

DC (mm)	Głębokość otworu (L/D)	TF15	Numer zamówieniowy	Wymiary (mm)							Typ
				LU	LCF	LH	OAL	LF	PL	DCON	
11.0	15	□	MNS1100-L15C	167.0	200.0	203.0	249.0	247	2.0	12	3
	20	●	MNS1100-L20C	222.0	255.0	258.0	304.0	302	2.0	12	3
	25	□	MNS1100-L25C	277.0	310.0	313.0	359.0	357	2.0	12	3
	5	★	MNS1100LB	57.0	90.0	90.0	151.0	149	2.0	11	3
	10	★	MNS1100X10DB	112.0	145.0	148.0	209.0	207	2.0	11	3
	20	★	MNS1100X20DB	222.0	255.0	258.0	319.0	317	2.0	11	3
11.1	3	□	MNS1110S-DIN	38.4	55.0	56.0	102.0	100	2.0	12	4
	3	□	MNS1110S-DIN-C	38.4	55.0	56.0	102.0	100	2.0	12	3
	5	□	MNS1110L-DIN	54.4	71.0	72.0	118.0	116	2.0	12	4
	5	□	MNS1110L-DIN-C	54.4	71.0	72.0	118.0	116	2.0	12	3
	8	□	MNS1110-L8C	90.8	129.0	132.0	178.0	176	2.0	12	3
	10	□	MNS1110-L10C	113.0	152.0	155.0	201.0	199	2.0	12	3
	12	□	MNS1110-L12C	135.2	175.0	178.0	224.0	222	2.0	12	3
	15	□	MNS1110-L15C	168.5	209.0	212.0	258.0	256	2.0	12	3
	20	□	MNS1110-L20C	224.0	267.0	270.0	316.0	314	2.0	12	3
	25	□	MNS1110-L25C	279.5	324.0	327.0	373.0	371	2.0	12	3
5	★	MNS1110LB	57.5	94.0	98.0	160.0	158	2.0	12	3	
10	□	MNS1110X10DB	113.0	152.0	155.0	217.0	215	2.0	12	3	
20	□	MNS1110X20DB	224.0	267.0	270.0	332.0	330	2.0	12	3	
11.2	3	□	MNS1120S-DIN	38.2	55.0	56.0	102.0	100	2.0	12	4
	3	□	MNS1120S-DIN-C	38.2	55.0	56.0	102.0	100	2.0	12	3
	5	□	MNS1120L-DIN	54.2	71.0	72.0	118.0	116	2.0	12	4
	5	□	MNS1120L-DIN-C	54.2	71.0	72.0	118.0	116	2.0	12	3
	8	□	MNS1120-L8C	91.6	129.0	132.0	178.0	176	2.0	12	3
	10	□	MNS1120-L10C	114.0	152.0	155.0	201.0	199	2.0	12	3
	12	□	MNS1120-L12C	136.4	175.0	178.0	224.0	222	2.0	12	3
	15	□	MNS1120-L15C	170.0	209.0	212.0	258.0	256	2.0	12	3
	20	□	MNS1120-L20C	226.0	267.0	270.0	316.0	314	2.0	12	3
	25	□	MNS1120-L25C	282.0	324.0	327.0	373.0	371	2.0	12	3
5	★	MNS1120LB	58.0	94.0	98.0	160.0	158	2.0	12	3	
10	□	MNS1120X10DB	114.0	152.0	155.0	217.0	215	2.0	12	3	
20	□	MNS1120X20DB	226.0	267.0	270.0	332.0	330	2.0	12	3	
11.3	3	□	MNS1130S-DIN	38.1	55.1	56.1	102.1	100	2.1	12	4
	3	□	MNS1130S-DIN-C	38.1	55.1	56.1	102.1	100	2.1	12	3
	5	□	MNS1130L-DIN	54.1	71.1	72.1	118.1	116	2.1	12	4
	5	□	MNS1130L-DIN-C	54.1	71.1	72.1	118.1	116	2.1	12	3
	8	□	MNS1130-L8C	92.5	129.1	132.1	178.1	176	2.1	12	3
	10	□	MNS1130-L10C	115.1	152.1	155.1	201.1	199	2.1	12	3
	12	□	MNS1130-L12C	137.7	175.1	178.1	224.1	222	2.1	12	3
	15	□	MNS1130-L15C	171.6	209.1	212.1	258.1	256	2.1	12	3
	20	□	MNS1130-L20C	228.1	267.1	270.1	316.1	314	2.1	12	3
	25	□	MNS1130-L25C	284.6	324.1	327.1	373.1	371	2.1	12	3
5	★	MNS1130LB	58.6	94.1	98.1	160.1	158	2.1	12	3	
10	□	MNS1130X10DB	115.1	152.1	155.1	217.1	215	2.1	12	3	
20	□	MNS1130X20DB	228.1	267.1	270.1	332.1	330	2.1	12	3	

WIERCENIE (WIERTŁA PEŁNOWĘGLIKOWE)

MNS

WĘGLIKI
SPIEKANE

M

WIERCENIE

DC (mm)	Głębokość otworu (L/D)	TF15	Numer zamówieniowy	Wymiary (mm)							Typ
				LU	LCF	LH	OAL	LF	PL	DCON	
11.4	3	□	MNS1140S-DIN	38.0	55.1	56.1	102.1	100	2.1	12	4
	3	□	MNS1140S-DIN-C	38.0	55.1	56.1	102.1	100	2.1	12	3
	5	□	MNS1140L-DIN	54.0	71.1	72.1	118.1	116	2.1	12	4
	5	□	MNS1140L-DIN-C	54.0	71.1	72.1	118.1	116	2.1	12	3
	8	□	MNS1140-L8C	93.3	129.1	132.1	178.1	176	2.1	12	3
	10	□	MNS1140-L10C	116.1	152.1	155.1	201.1	199	2.1	12	3
	12	□	MNS1140-L12C	138.9	175.1	178.1	224.1	222	2.1	12	3
	15	□	MNS1140-L15C	173.1	209.1	212.1	258.1	256	2.1	12	3
	20	□	MNS1140-L20C	230.1	267.1	270.1	316.1	314	2.1	12	3
	25	□	MNS1140-L25C	287.1	324.1	327.1	373.1	371	2.1	12	3
5	★	MNS1140LB	59.1	94.1	98.1	160.1	158	2.1	12	3	
10	□	MNS1140X10DB	116.1	152.1	155.1	217.1	215	2.1	12	3	
20	□	MNS1140X20DB	230.1	267.1	270.1	332.1	330	2.1	12	3	
11.5	3	□	MNS1150S-DIN	37.8	55.1	56.1	102.1	100	2.1	12	4
	3	□	MNS1150S-DIN-C	37.8	55.1	56.1	102.1	100	2.1	12	3
	5	□	MNS1150L-DIN	53.8	71.1	72.1	118.1	116	2.1	12	4
	5	●	MNS1150L-DIN-C	53.8	71.1	72.1	118.1	116	2.1	12	3
	8	□	MNS1150-L8C	94.1	129.1	132.1	178.1	176	2.1	12	3
	10	□	MNS1150-L10C	117.1	152.1	155.1	201.1	199	2.1	12	3
	12	●	MNS1150-L12C	140.1	175.1	178.1	224.1	222	2.1	12	3
	15	□	MNS1150-L15C	174.6	209.1	212.1	258.1	256	2.1	12	3
	20	●	MNS1150-L20C	232.1	267.1	270.1	316.1	314	2.1	12	3
	25	□	MNS1150-L25C	289.6	324.1	327.1	373.1	371	2.1	12	3
5	★	MNS1150LB	59.6	94.1	98.1	160.1	158	2.1	12	3	
10	□	MNS1150X10DB	117.1	152.1	155.1	217.1	215	2.1	12	3	
20	□	MNS1150X20DB	232.1	267.1	270.1	332.1	330	2.1	12	3	
11.6	3	□	MNS1160S-DIN	37.7	55.1	56.1	102.1	100	2.1	12	4
	3	□	MNS1160S-DIN-C	37.7	55.1	56.1	102.1	100	2.1	12	3
	5	□	MNS1160L-DIN	53.7	71.1	72.1	118.1	116	2.1	12	4
	5	□	MNS1160L-DIN-C	53.7	71.1	72.1	118.1	116	2.1	12	3
	8	□	MNS1160-L8C	94.9	134.1	137.1	183.1	181	2.1	12	3
	10	□	MNS1160-L10C	118.1	158.1	161.1	207.1	205	2.1	12	3
	12	□	MNS1160-L12C	141.3	182.1	185.1	231.1	229	2.1	12	3
	15	□	MNS1160-L15C	176.1	218.1	221.1	267.1	265	2.1	12	3
	20	□	MNS1160-L20C	234.1	278.1	281.1	327.1	325	2.1	12	3
	25	□	MNS1160-L25C	292.1	338.1	341.1	387.1	385	2.1	12	3
5	★	MNS1160LB	60.1	98.1	98.1	160.1	158	2.1	12	3	
10	□	MNS1160X10DB	118.1	158.1	161.1	223.1	221	2.1	12	3	
20	□	MNS1160X20DB	234.1	278.1	281.1	343.1	341	2.1	12	3	
11.7	3	□	MNS1170S-DIN	37.6	55.1	56.1	102.1	100	2.1	12	4
	3	□	MNS1170S-DIN-C	37.6	55.1	56.1	102.1	100	2.1	12	3
	5	□	MNS1170L-DIN	53.6	71.1	72.1	118.1	116	2.1	12	4
	5	□	MNS1170L-DIN-C	53.6	71.1	72.1	118.1	116	2.1	12	3
	8	□	MNS1170-L8C	95.7	134.1	137.1	183.1	181	2.1	12	3
	10	□	MNS1170-L10C	119.1	158.1	161.1	207.1	205	2.1	12	3
	12	□	MNS1170-L12C	142.5	182.1	185.1	231.1	229	2.1	12	3

DC (mm)	Głębokość otworu (L/D)	TF15	Numer zamówieniowy	Wymiary (mm)							Typ
				LU	LCF	LH	OAL	LF	PL	DCON	
11.7	15	□	MNS1170-L15C	177.6	218.1	221.1	267.1	265	2.1	12	3
	20	□	MNS1170-L20C	236.1	278.1	281.1	327.1	325	2.1	12	3
	25	□	MNS1170-L25C	294.6	338.1	341.1	387.1	385	2.1	12	3
	5	★	MNS1170LB	60.6	98.1	98.1	160.1	158	2.1	12	3
	10	□	MNS1170X10DB	119.1	158.1	161.1	223.1	221	2.1	12	3
	20	□	MNS1170X20DB	236.1	278.1	281.1	343.1	341	2.1	12	3
11.8	3	□	MNS1180S-DIN	37.4	55.1	56.1	102.1	100	2.1	12	4
	3	□	MNS1180S-DIN-C	37.4	55.1	56.1	102.1	100	2.1	12	3
	5	□	MNS1180L-DIN	53.4	71.1	72.1	118.1	116	2.1	12	4
	5	□	MNS1180L-DIN-C	53.4	71.1	72.1	118.1	116	2.1	12	3
	8	□	MNS1180-L8C	96.5	134.1	137.1	183.1	181	2.1	12	3
	10	□	MNS1180-L10C	120.1	158.1	161.1	207.1	205	2.1	12	3
	12	□	MNS1180-L12C	143.7	182.1	185.1	231.1	229	2.1	12	3
	15	□	MNS1180-L15C	179.1	218.1	221.1	267.1	265	2.1	12	3
	20	□	MNS1180-L20C	238.1	278.1	281.1	327.1	325	2.1	12	3
	25	□	MNS1180-L25C	297.1	338.1	341.1	387.1	385	2.1	12	3
5	★	MNS1180LB	61.1	98.1	98.1	160.1	158	2.1	12	3	
10	□	MNS1180X10DB	120.1	158.1	161.1	223.1	221	2.1	12	3	
20	□	MNS1180X20DB	238.1	278.1	281.1	343.1	341	2.1	12	3	
11.9	3	□	MNS1190S-DIN	37.3	55.2	56.2	102.2	100	2.2	12	4
	3	□	MNS1190S-DIN-C	37.3	55.2	56.2	102.2	100	2.2	12	3
	5	□	MNS1190L-DIN	53.3	71.2	72.2	118.2	116	2.2	12	4
	5	□	MNS1190L-DIN-C	53.3	71.2	72.2	118.2	116	2.2	12	3
	8	□	MNS1190-L8C	97.4	134.2	137.2	183.2	181	2.2	12	3
	10	□	MNS1190-L10C	121.2	158.2	161.2	207.2	205	2.2	12	3
	12	□	MNS1190-L12C	145.0	182.2	185.2	231.2	229	2.2	12	3
	15	□	MNS1190-L15C	180.7	218.2	221.2	267.2	265	2.2	12	3
	20	□	MNS1190-L20C	240.2	278.2	281.2	327.2	325	2.2	12	3
	25	□	MNS1190-L25C	299.7	338.2	341.2	387.2	385	2.2	12	3
5	★	MNS1190LB	61.7	98.2	98.2	160.2	158	2.2	12	3	
10	□	MNS1190X10DB	121.2	158.2	161.2	223.2	221	2.2	12	3	
20	□	MNS1190X20DB	240.2	278.2	281.2	343.2	341	2.2	12	3	
12.0	3	□	MNS1200S-DIN	37.2	55.2	56.2	102.2	100	2.2	12	4
	3	□	MNS1200S-DIN-C	37.2	55.2	56.2	102.2	100	2.2	12	3
	5	□	MNS1200L-DIN	53.2	71.2	72.2	118.2	116	2.2	12	4
	5	●	MNS1200L-DIN-C	53.2	71.2	72.2	118.2	116	2.2	12	3
	8	□	MNS1200-L8C	98.2	134.2	137.2	183.2	181	2.2	12	3
	10	□	MNS1200-L10C	122.2	158.2	161.2	207.2	205	2.2	12	3
	12	●	MNS1200-L12C	146.2	182.2	185.2	231.2	229	2.2	12	3
	15	□	MNS1200-L15C	182.2	218.2	221.2	267.2	265	2.2	12	3
	20	●	MNS1200-L20C	242.2	278.2	281.2	327.2	325	2.2	12	3
	25	□	MNS1200-L25C	302.2	338.2	341.2	387.2	385	2.2	12	3
5	★	MNS1200LB	62.2	98.2	98.2	160.2	158	2.2	12	3	
10	★	MNS1200X10DB	122.2	158.2	161.2	223.2	221	2.2	12	3	
20	★	MNS1200X20DB	242.2	278.2	281.2	343.2	341	2.2	12	3	

Uwaga 1) Gdy geometria wiertła nie odpowiada wartościom podanym w tabeli (np. inna średnica i długość wiertła), prosimy o skontaktowanie się z naszą firmą.

● : Standard magazynowy. ★ : Na specjalne zamówienie z magazynu w Japonii.

□ : Niestandardowy, produkowany na specjalne zamówienie.

DC (mm)	Głębokość otworu (L/D)	TF15	Numer zamówieniowy	Wymiary (mm)							Typ
				LU	LCF	LH	OAL	LF	PL	DCON	
12.1	3	□	MNS1210S-DIN	42.1	60.2	61.2	107.2	105	2.2	14	4
	3	□	MNS1210S-DIN-C	42.1	60.2	61.2	107.2	105	2.2	14	3
	5	□	MNS1210L-DIN	59.1	77.2	78.2	124.2	122	2.2	14	4
	5	□	MNS1210L-DIN-C	59.1	77.2	78.2	124.2	122	2.2	14	3
	8	□	MNS1210-L8C	99.0	140.2	143.2	189.2	187	2.2	14	3
	10	□	MNS1210-L10C	123.2	165.2	168.2	214.2	212	2.2	14	3
	12	□	MNS1210-L12C	147.4	190.2	193.2	239.2	237	2.2	14	3
	15	□	MNS1210-L15C	183.7	227.2	230.2	276.2	274	2.2	14	3
	20	□	MNS1210-L20C	244.2	290.2	293.2	339.2	337	2.2	14	3
	5	★	MNS1210LB	62.7	102.2	106.2	169.2	167	2.2	13	3
10	□	MNS1210X10DB	123.2	165.2	168.2	231.2	229	2.2	13	3	
20	□	MNS1210X20DB	244.2	290.2	293.2	356.2	354	2.2	13	3	
12.2	3	□	MNS1220S-DIN	41.9	60.2	61.2	107.2	105	2.2	14	4
	3	□	MNS1220S-DIN-C	41.9	60.2	61.2	107.2	105	2.2	14	3
	5	□	MNS1220L-DIN	58.9	77.2	78.2	124.2	122	2.2	14	4
	5	□	MNS1220L-DIN-C	58.9	77.2	78.2	124.2	122	2.2	14	3
	8	□	MNS1220-L8C	99.8	140.2	143.2	189.2	187	2.2	14	3
	10	□	MNS1220-L10C	124.2	165.2	168.2	214.2	212	2.2	14	3
	12	□	MNS1220-L12C	148.6	190.2	193.2	239.2	237	2.2	14	3
	15	□	MNS1220-L15C	185.2	227.2	230.2	276.2	274	2.2	14	3
	20	□	MNS1220-L20C	246.2	290.2	293.2	339.2	337	2.2	14	3
	5	★	MNS1220LB	63.2	102.2	106.2	169.2	167	2.2	13	3
10	□	MNS1220X10DB	124.2	165.2	168.2	231.2	229	2.2	13	3	
20	□	MNS1220X20DB	246.2	290.2	293.2	356.2	354	2.2	13	3	
12.3	3	□	MNS1230S-DIN	41.8	60.2	61.2	107.2	105	2.2	14	4
	3	□	MNS1230S-DIN-C	41.8	60.2	61.2	107.2	105	2.2	14	3
	5	□	MNS1230L-DIN	58.8	77.2	78.2	124.2	122	2.2	14	4
	5	□	MNS1230L-DIN-C	58.8	77.2	78.2	124.2	122	2.2	14	3
	8	□	MNS1230-L8C	100.6	140.2	143.2	189.2	187	2.2	14	3
	10	□	MNS1230-L10C	125.2	165.2	168.2	214.2	212	2.2	14	3
	12	□	MNS1230-L12C	149.8	190.2	193.2	239.2	237	2.2	14	3
	15	□	MNS1230-L15C	186.7	227.2	230.2	276.2	274	2.2	14	3
	20	□	MNS1230-L20C	248.2	290.2	293.2	339.2	337	2.2	14	3
	5	★	MNS1230LB	63.7	102.2	106.2	169.2	167	2.2	13	3
10	□	MNS1230X10DB	125.2	165.2	168.2	231.2	229	2.2	13	3	
20	□	MNS1230X20DB	248.2	290.2	293.2	356.2	354	2.2	13	3	
12.4	3	□	MNS1240S-DIN	41.7	60.3	61.3	107.3	105	2.3	14	4
	3	□	MNS1240S-DIN-C	41.7	60.3	61.3	107.3	105	2.3	14	3
	5	□	MNS1240L-DIN	58.7	77.3	78.3	124.3	122	2.3	14	4
	5	□	MNS1240L-DIN-C	58.7	77.3	78.3	124.3	122	2.3	14	3
	8	□	MNS1240-L8C	101.5	140.3	143.3	189.3	187	2.3	14	3
	10	□	MNS1240-L10C	126.3	165.3	168.3	214.3	212	2.3	14	3
	12	□	MNS1240-L12C	151.1	190.3	193.3	239.3	237	2.3	14	3
	15	□	MNS1240-L15C	188.3	227.3	230.3	276.3	274	2.3	14	3
	20	□	MNS1240-L20C	250.3	290.3	293.3	339.3	337	2.3	14	3
	5	★	MNS1240LB	64.3	102.3	106.3	169.3	167	2.3	13	3
10	□	MNS1240X10DB	126.3	165.3	168.3	231.3	229	2.3	13	3	
20	□	MNS1240X20DB	250.3	290.3	293.3	356.3	354	2.3	13	3	

DC (mm)	Głębokość otworu (L/D)	TF15	Numer zamówieniowy	Wymiary (mm)							Typ
				LU	LCF	LH	OAL	LF	PL	DCON	
12.5	3	□	MNS1250S-DIN	41.5	60.3	61.3	107.3	105	2.3	14	4
	3	□	MNS1250S-DIN-C	41.5	60.3	61.3	107.3	105	2.3	14	3
	5	□	MNS1250L-DIN	58.5	77.3	78.3	124.3	122	2.3	14	4
	5	●	MNS1250L-DIN-C	58.5	77.3	78.3	124.3	122	2.3	14	3
	8	□	MNS1250-L8C	102.3	140.3	143.3	189.3	187	2.3	14	3
	10	□	MNS1250-L10C	127.3	165.3	168.3	214.3	212	2.3	14	3
	12	●	MNS1250-L12C	152.3	190.3	193.3	239.3	237	2.3	14	3
	15	□	MNS1250-L15C	189.8	227.3	230.3	276.3	274	2.3	14	3
	20	●	MNS1250-L20C	252.3	290.3	293.3	339.3	337	2.3	14	3
	5	★	MNS1250LB	64.8	102.3	106.3	169.3	167	2.3	13	3
10	□	MNS1250X10DB	127.3	165.3	168.3	231.3	229	2.3	13	3	
20	□	MNS1250X20DB	252.3	290.3	293.3	356.3	354	2.3	13	3	
12.6	3	□	MNS1260S-DIN	41.4	60.3	61.3	107.3	105	2.3	14	4
	3	□	MNS1260S-DIN-C	41.4	60.3	61.3	107.3	105	2.3	14	3
	5	□	MNS1260L-DIN	58.4	77.3	78.3	124.3	122	2.3	14	4
	5	□	MNS1260L-DIN-C	58.4	77.3	78.3	124.3	122	2.3	14	3
	8	□	MNS1260-L8C	103.1	145.3	148.3	194.3	192	2.3	14	3
	10	□	MNS1260-L10C	128.3	171.3	174.3	220.3	218	2.3	14	3
	12	□	MNS1260-L12C	153.5	197.3	200.3	246.3	244	2.3	14	3
	15	□	MNS1260-L15C	191.3	236.3	239.3	285.3	283	2.3	14	3
	20	□	MNS1260-L20C	254.3	301.3	304.3	350.3	348	2.3	14	3
	5	★	MNS1260LB	65.3	106.3	106.3	169.3	167	2.3	13	3
10	□	MNS1260X10DB	128.3	171.3	174.3	237.3	235	2.3	13	3	
20	□	MNS1260X20DB	254.3	301.3	304.3	367.3	365	2.3	13	3	
12.7	3	□	MNS1270S-DIN	41.3	60.3	61.3	107.3	105	2.3	14	4
	3	□	MNS1270S-DIN-C	41.3	60.3	61.3	107.3	105	2.3	14	3
	5	□	MNS1270L-DIN	58.3	77.3	78.3	124.3	122	2.3	14	4
	5	□	MNS1270L-DIN-C	58.3	77.3	78.3	124.3	122	2.3	14	3
	8	□	MNS1270-L8C	103.9	145.3	148.3	194.3	192	2.3	14	3
	10	□	MNS1270-L10C	129.3	171.3	174.3	220.3	218	2.3	14	3
	12	□	MNS1270-L12C	154.7	197.3	200.3	246.3	244	2.3	14	3
	15	□	MNS1270-L15C	192.8	236.3	239.3	285.3	283	2.3	14	3
	20	□	MNS1270-L20C	256.3	301.3	304.3	350.3	348	2.3	14	3
	5	★	MNS1270LB	65.8	106.3	106.3	169.3	167	2.3	13	3
10	□	MNS1270X10DB	129.3	171.3	174.3	237.3	235	2.3	13	3	
20	□	MNS1270X20DB	256.3	301.3	304.3	367.3	365	2.3	13	3	
12.8	3	□	MNS1280S-DIN	41.1	60.3	61.3	107.3	105	2.3	14	4
	3	□	MNS1280S-DIN-C	41.1	60.3	61.3	107.3	105	2.3	14	3
	5	□	MNS1280L-DIN	58.1	77.3	78.3	124.3	122	2.3	14	4
	5	□	MNS1280L-DIN-C	58.1	77.3	78.3	124.3	122	2.3	14	3
	8	□	MNS1280-L8C	104.7	145.3	148.3	194.3	192	2.3	14	3
	10	□	MNS1280-L10C	130.3	171.3	174.3	220.3	218	2.3	14	3
	12	□	MNS1280-L12C	155.9	197.3	200.3	246.3	244	2.3	14	3
	15	□	MNS1280-L15C	194.3	236.3	239.3	285.3	283	2.3	14	3
	20	□	MNS1280-L20C	258.3	301.3	304.3	350.3	348	2.3	14	3
	5	★	MNS1280LB	66.3	106.3	106.3	169.3	167	2.3	13	3
10	□	MNS1280X10DB	130.3	171.3	174.3	237.3	235	2.3	13	3	
20	□	MNS1280X20DB	258.3	301.3	304.3	367.3	365	2.3	13	3	

WIERCENIE (WIERTŁA PEŁNOWĘGLIKOWE)

MNS

WĘGLIKI
SPIEKANE

M

WIERCENIE

DC (mm)	Głębokość otworu (L/D)	TF15	Numer zamówieniowy	Wymiary (mm)							Typ
				LU	LCF	LH	OAL	LF	PL	DCON	
12.9	3	□	MNS1290S-DIN	41.0	60.3	61.3	107.3	105	2.3	14	4
	3	□	MNS1290S-DIN-C	41.0	60.3	61.3	107.3	105	2.3	14	3
	5	□	MNS1290L-DIN	58.0	77.3	78.3	124.3	122	2.3	14	4
	5	□	MNS1290L-DIN-C	58.0	77.3	78.3	124.3	122	2.3	14	3
	8	□	MNS1290-L8C	105.5	145.3	148.3	194.3	192	2.3	14	3
	10	□	MNS1290-L10C	131.3	171.3	174.3	220.3	218	2.3	14	3
	12	□	MNS1290-L12C	157.1	197.3	200.3	246.3	244	2.3	14	3
	15	□	MNS1290-L15C	195.8	236.3	239.3	285.3	283	2.3	14	3
	20	□	MNS1290-L20C	260.3	301.3	304.3	350.3	348	2.3	14	3
	5	★	MNS1290LB	66.8	106.3	106.3	169.3	167	2.3	13	3
10	□	MNS1290X10DB	131.3	171.3	174.3	237.3	235	2.3	13	3	
20	□	MNS1290X20DB	260.3	301.3	304.3	367.3	365	2.3	13	3	
13.0	3	□	MNS1300S-DIN	40.9	60.4	61.4	107.4	105	2.4	14	4
	3	□	MNS1300S-DIN-C	40.9	60.4	61.4	107.4	105	2.4	14	3
	5	□	MNS1300L-DIN	57.9	77.4	78.4	124.4	122	2.4	14	4
	5	●	MNS1300L-DIN-C	57.9	77.4	78.4	124.4	122	2.4	14	3
	8	□	MNS1300-L8C	106.4	145.4	148.4	194.4	192	2.4	14	3
	10	□	MNS1300-L10C	132.4	171.4	174.4	220.4	218	2.4	14	3
	12	●	MNS1300-L12C	158.4	197.4	200.4	246.4	244	2.4	14	3
	15	□	MNS1300-L15C	197.4	236.4	239.4	285.4	283	2.4	14	3
	20	●	MNS1300-L20C	262.4	301.4	304.4	350.4	348	2.4	14	3
	5	★	MNS1300LB	67.4	106.4	106.4	169.4	167	2.4	13	3
10	★	MNS1300X10DB	132.4	171.4	174.4	237.4	235	2.4	13	3	
20	★	MNS1300X20DB	262.4	301.4	304.4	367.4	365	2.4	13	3	
13.1	3	□	MNS1310S-DIN	40.7	60.4	61.4	107.4	105	2.4	14	4
	3	□	MNS1310S-DIN-C	40.7	60.4	61.4	107.4	105	2.4	14	3
	5	□	MNS1310L-DIN	57.7	77.4	78.4	124.4	122	2.4	14	4
	5	□	MNS1310L-DIN-C	57.7	77.4	78.4	124.4	122	2.4	14	3
	8	□	MNS1310-L8C	107.2	151.4	154.4	200.4	198	2.4	14	3
	10	□	MNS1310-L10C	133.4	178.4	181.4	227.4	225	2.4	14	3
	12	□	MNS1310-L12C	159.6	205.4	208.4	254.4	252	2.4	14	3
	15	□	MNS1310-L15C	198.9	245.4	248.4	294.4	292	2.4	14	3
	20	□	MNS1310-L20C	264.4	313.4	316.4	362.4	360	2.4	14	3
	5	★	MNS1310LB	67.9	110.4	114.4	178.4	176	2.4	14	3
10	□	MNS1310X10DB	133.4	178.4	181.4	245.4	243	2.4	14	3	
20	□	MNS1310X20DB	264.4	313.4	316.4	380.4	378	2.4	14	3	
13.2	3	□	MNS1320S-DIN	40.6	60.4	61.4	107.4	105	2.4	14	4
	3	□	MNS1320S-DIN-C	40.6	60.4	61.4	107.4	105	2.4	14	3
	5	□	MNS1320L-DIN	57.6	77.4	78.4	124.4	122	2.4	14	4
	5	□	MNS1320L-DIN-C	57.6	77.4	78.4	124.4	122	2.4	14	3
	8	□	MNS1320-L8C	108.0	151.4	154.4	200.4	198	2.4	14	3
	10	□	MNS1320-L10C	134.4	178.4	181.4	227.4	225	2.4	14	3
	12	□	MNS1320-L12C	160.8	205.4	208.4	254.4	252	2.4	14	3
	15	□	MNS1320-L15C	200.4	245.4	248.4	294.4	292	2.4	14	3
	20	□	MNS1320-L20C	266.4	313.4	316.4	362.4	360	2.4	14	3
	5	★	MNS1320LB	68.4	110.4	114.4	178.4	176	2.4	14	3
10	□	MNS1320X10DB	134.4	178.4	181.4	245.4	243	2.4	14	3	
20	□	MNS1320X20DB	266.4	313.4	316.4	380.4	378	2.4	14	3	

DC (mm)	Głębokość otworu (L/D)	TF15	Numer zamówieniowy	Wymiary (mm)							Typ
				LU	LCF	LH	OAL	LF	PL	DCON	
13.3	3	□	MNS1330S-DIN	40.5	60.4	61.4	107.4	105	2.4	14	4
	3	□	MNS1330S-DIN-C	40.5	60.4	61.4	107.4	105	2.4	14	3
	5	□	MNS1330L-DIN	57.5	77.4	78.4	124.4	122	2.4	14	4
	5	□	MNS1330L-DIN-C	57.5	77.4	78.4	124.4	122	2.4	14	3
	8	□	MNS1330-L8C	108.8	151.4	154.4	200.4	198	2.4	14	3
	10	□	MNS1330-L10C	135.4	178.4	181.4	227.4	225	2.4	14	3
	12	□	MNS1330-L12C	162.0	205.4	208.4	254.4	252	2.4	14	3
	15	□	MNS1330-L15C	201.9	245.4	248.4	294.4	292	2.4	14	3
	20	□	MNS1330-L20C	268.4	313.4	316.4	362.4	360	2.4	14	3
	5	★	MNS1330LB	68.9	110.4	114.4	178.4	176	2.4	14	3
10	□	MNS1330X10DB	135.4	178.4	181.4	245.4	243	2.4	14	3	
20	□	MNS1330X20DB	268.4	313.4	316.4	380.4	378	2.4	14	3	
13.4	3	□	MNS1340S-DIN	40.3	60.4	61.4	107.4	105	2.4	14	4
	3	□	MNS1340S-DIN-C	40.3	60.4	61.4	107.4	105	2.4	14	3
	5	□	MNS1340L-DIN	57.3	77.4	78.4	124.4	122	2.4	14	4
	5	□	MNS1340L-DIN-C	57.3	77.4	78.4	124.4	122	2.4	14	3
	8	□	MNS1340-L8C	109.6	151.4	154.4	200.4	198	2.4	14	3
	10	□	MNS1340-L10C	136.4	178.4	181.4	227.4	225	2.4	14	3
	12	□	MNS1340-L12C	163.2	205.4	208.4	254.4	252	2.4	14	3
	15	□	MNS1340-L15C	203.4	245.4	248.4	294.4	292	2.4	14	3
	20	□	MNS1340-L20C	270.4	313.4	316.4	362.4	360	2.4	14	3
	5	★	MNS1340LB	69.4	110.4	114.4	178.4	176	2.4	14	3
10	□	MNS1340X10DB	136.4	178.4	181.4	245.4	243	2.4	14	3	
20	□	MNS1340X20DB	270.4	313.4	316.4	380.4	378	2.4	14	3	
13.5	3	□	MNS1350S-DIN	40.2	60.5	61.5	107.5	105	2.5	14	4
	3	□	MNS1350S-DIN-C	40.2	60.5	61.5	107.5	105	2.5	14	3
	5	□	MNS1350L-DIN	57.2	77.5	78.5	124.5	122	2.5	14	4
	5	●	MNS1350L-DIN-C	57.2	77.5	78.5	124.5	122	2.5	14	3
	8	□	MNS1350-L8C	110.5	151.5	154.5	200.5	198	2.5	14	3
	10	□	MNS1350-L10C	137.5	178.5	181.5	227.5	225	2.5	14	3
	12	●	MNS1350-L12C	164.5	205.5	208.5	254.5	252	2.5	14	3
	15	□	MNS1350-L15C	205.0	245.5	248.5	294.5	292	2.5	14	3
	20	●	MNS1350-L20C	272.5	313.5	316.5	362.5	360	2.5	14	3
	5	★	MNS1350LB	70.0	110.5	114.5	178.5	176	2.5	14	3
10	□	MNS1350X10DB	137.5	178.5	181.5	245.5	243	2.5	14	3	
20	□	MNS1350X20DB	272.5	313.5	316.5	380.5	378	2.5	14	3	
13.6	3	□	MNS1360S-DIN	40.1	60.5	61.5	107.5	105	2.5	14	4
	3	□	MNS1360S-DIN-C	40.1	60.5	61.5	107.5	105	2.5	14	3
	5	□	MNS1360L-DIN	57.1	77.5	78.5	124.5	122	2.5	14	4
	5	□	MNS1360L-DIN-C	57.1	77.5	78.5	124.5	122	2.5	14	3
	8	□	MNS1360-L8C	111.3	156.5	159.5	205.5	203	2.5	14	3
	10	□	MNS1360-L10C	138.5	184.5	187.5	233.5	231	2.5	14	3
	12	□	MNS1360-L12C	165.7	212.5	215.5	261.5	259	2.5	14	3
	15	□	MNS1360-L15C	206.5	254.5	257.5	303.5	301	2.5	14	3
	20	□	MNS1360-L20C	274.5	324.5	327.5	373.5	371	2.5	14	3
	5	★	MNS1360LB	70.5	114.5	114.5	178.5	176	2.5	14	3
10	□	MNS1360X10DB	138.5	184.5	187.5	251.5	249	2.5	14	3	
20	□	MNS1360X20DB	274.5	324.5	327.5	391.5	389	2.5	14	3	

Uwaga 1) Gdy geometria wiertła nie odpowiada wartościom podanym w tabeli (np. inna średnica i długość wiertła), prosimy o skontaktowanie się z naszą firmą.

● : Standard magazynowy. ★ : Na specjalne zamówienie z magazynu w Japonii.

□ : Niestandardowy, produkowany na specjalne zamówienie.

DC (mm)	Głębokość otworu (L/D)	TF15	Numer zamówieniowy	Wymiary (mm)							Typ
				LU	LCF	LH	OAL	LF	PL	DCON	
13.7	3	□	MNS1370S-DIN	39.9	60.5	61.5	107.5	105	2.5	14	4
	3	□	MNS1370S-DIN-C	39.9	60.5	61.5	107.5	105	2.5	14	3
	5	□	MNS1370L-DIN	56.9	77.5	78.5	124.5	122	2.5	14	4
	5	□	MNS1370L-DIN-C	56.9	77.5	78.5	124.5	122	2.5	14	3
	8	□	MNS1370-L8C	112.1	156.5	159.5	205.5	203	2.5	14	3
	10	□	MNS1370-L10C	139.5	184.5	187.5	233.5	231	2.5	14	3
	12	□	MNS1370-L12C	166.9	212.5	215.5	261.5	259	2.5	14	3
	15	□	MNS1370-L15C	208.0	254.5	257.5	303.5	301	2.5	14	3
	20	□	MNS1370-L20C	276.5	324.5	327.5	373.5	371	2.5	14	3
	5	★	MNS1370LB	71.0	114.5	114.5	178.5	176	2.5	14	3
10	□	MNS1370X10DB	139.5	184.5	187.5	251.5	249	2.5	14	3	
20	□	MNS1370X20DB	276.5	324.5	327.5	391.5	389	2.5	14	3	
13.8	3	□	MNS1380S-DIN	39.8	60.5	61.5	107.5	105	2.5	14	4
	3	□	MNS1380S-DIN-C	39.8	60.5	61.5	107.5	105	2.5	14	3
	5	□	MNS1380L-DIN	56.8	77.5	78.5	124.5	122	2.5	14	4
	5	□	MNS1380L-DIN-C	56.8	77.5	78.5	124.5	122	2.5	14	3
	8	□	MNS1380-L8C	112.9	156.5	159.5	205.5	203	2.5	14	3
	10	□	MNS1380-L10C	140.5	184.5	187.5	233.5	231	2.5	14	3
	12	□	MNS1380-L12C	168.1	212.5	215.5	261.5	259	2.5	14	3
	15	□	MNS1380-L15C	209.5	254.5	257.5	303.5	301	2.5	14	3
	20	□	MNS1380-L20C	278.5	324.5	327.5	373.5	371	2.5	14	3
	5	★	MNS1380LB	71.5	114.5	114.5	178.5	176	2.5	14	3
10	□	MNS1380X10DB	140.5	184.5	187.5	251.5	249	2.5	14	3	
20	□	MNS1380X20DB	278.5	324.5	327.5	391.5	389	2.5	14	3	
13.9	3	□	MNS1390S-DIN	39.7	60.5	61.5	107.5	105	2.5	14	4
	3	□	MNS1390S-DIN-C	39.7	60.5	61.5	107.5	105	2.5	14	3
	5	□	MNS1390L-DIN	56.7	77.5	78.5	124.5	122	2.5	14	4
	5	□	MNS1390L-DIN-C	56.7	77.5	78.5	124.5	122	2.5	14	3
	8	□	MNS1390-L8C	113.7	156.5	159.5	205.5	203	2.5	14	3
	10	□	MNS1390-L10C	141.5	184.5	187.5	233.5	231	2.5	14	3
	12	□	MNS1390-L12C	169.3	212.5	215.5	261.5	259	2.5	14	3
	15	□	MNS1390-L15C	211.0	254.5	257.5	303.5	301	2.5	14	3
	20	□	MNS1390-L20C	280.5	324.5	327.5	373.5	371	2.5	14	3
	5	★	MNS1390LB	72.0	114.5	114.5	178.5	176	2.5	14	3
10	□	MNS1390X10DB	141.5	184.5	187.5	251.5	249	2.5	14	3	
20	□	MNS1390X20DB	280.5	324.5	327.5	391.5	389	2.5	14	3	
14.0	3	□	MNS1400S-DIN	39.5	60.5	61.5	107.5	105	2.5	14	4
	3	□	MNS1400S-DIN-C	39.5	60.5	61.5	107.5	105	2.5	14	3
	5	□	MNS1400L-DIN	56.5	77.5	78.5	124.5	122	2.5	14	4
	5	●	MNS1400L-DIN-C	56.5	77.5	78.5	124.5	122	2.5	14	3
	8	□	MNS1400-L8C	114.5	156.5	159.5	205.5	203	2.5	14	3
	10	□	MNS1400-L10C	142.5	184.5	187.5	233.5	231	2.5	14	3
	12	●	MNS1400-L12C	170.5	212.5	215.5	261.5	259	2.5	14	3
	15	□	MNS1400-L15C	212.5	254.5	257.5	303.5	301	2.5	14	3
	20	●	MNS1400-L20C	282.5	324.5	327.5	373.5	371	2.5	14	3
	5	★	MNS1400LB	72.5	114.5	114.5	178.5	176	2.5	14	3
10	★	MNS1400X10DB	142.5	184.5	187.5	251.5	249	2.5	14	3	
20	★	MNS1400X20DB	282.5	324.5	327.5	391.5	389	2.5	14	3	

DC (mm)	Głębokość otworu (L/D)	TF15	Numer zamówieniowy	Wymiary (mm)							Typ
				LU	LCF	LH	OAL	LF	PL	DCON	
14.1	3	□	MNS1410S-DIN	43.4	64.6	65.6	114.6	112	2.6	16	4
	3	□	MNS1410S-DIN-C	43.4	64.6	65.6	114.6	112	2.6	16	3
	5	□	MNS1410L-DIN	61.4	82.6	83.6	132.6	130	2.6	16	4
	5	□	MNS1410L-DIN-C	61.4	82.6	83.6	132.6	130	2.6	16	3
14.2	3	□	MNS1420S-DIN	43.3	64.6	65.6	114.6	112	2.6	16	4
	3	□	MNS1420S-DIN-C	43.3	64.6	65.6	114.6	112	2.6	16	3
	5	□	MNS1420L-DIN	61.3	82.6	83.6	132.6	130	2.6	16	4
14.3	3	□	MNS1430S-DIN	43.2	64.6	65.6	114.6	112	2.6	16	4
	3	□	MNS1430S-DIN-C	43.2	64.6	65.6	114.6	112	2.6	16	3
	5	□	MNS1430L-DIN	61.2	82.6	83.6	132.6	130	2.6	16	4
14.4	3	□	MNS1440S-DIN	43.0	64.6	65.6	114.6	112	2.6	16	4
	3	□	MNS1440S-DIN-C	43.0	64.6	65.6	114.6	112	2.6	16	3
	5	□	MNS1440L-DIN	61.0	82.6	83.6	132.6	130	2.6	16	4
	5	□	MNS1440L-DIN-C	61.0	82.6	83.6	132.6	130	2.6	16	3
14.5	3	□	MNS1450S-DIN	42.9	64.6	65.6	114.6	112	2.6	16	4
	3	□	MNS1450S-DIN-C	42.9	64.6	65.6	114.6	112	2.6	16	3
	5	□	MNS1450L-DIN	60.9	82.6	83.6	132.6	130	2.6	16	4
14.6	3	□	MNS1460S-DIN	42.8	64.7	65.7	114.7	112	2.7	16	4
	3	□	MNS1460S-DIN-C	42.8	64.7	65.7	114.7	112	2.7	16	3
	5	□	MNS1460L-DIN	60.8	82.7	83.7	132.7	130	2.7	16	4
	5	□	MNS1460L-DIN-C	60.8	82.7	83.7	132.7	130	2.7	16	3
14.7	3	□	MNS1470S-DIN	42.6	64.7	65.7	114.7	112	2.7	16	4
	3	□	MNS1470S-DIN-C	42.6	64.7	65.7	114.7	112	2.7	16	3
	5	□	MNS1470L-DIN	60.6	82.7	83.7	132.7	130	2.7	16	4
	5	□	MNS1470L-DIN-C	60.6	82.7	83.7	132.7	130	2.7	16	3
14.8	3	□	MNS1480S-DIN	42.5	64.7	65.7	114.7	112	2.7	16	4
	3	□	MNS1480S-DIN-C	42.5	64.7	65.7	114.7	112	2.7	16	3
	5	□	MNS1480L-DIN	60.5	82.7	83.7	132.7	130	2.7	16	4
14.9	3	□	MNS1490S-DIN	42.4	64.7	65.7	114.7	112	2.7	16	4
	3	□	MNS1490S-DIN-C	42.4	64.7	65.7	114.7	112	2.7	16	3
	5	□	MNS1490L-DIN	60.4	82.7	83.7	132.7	130	2.7	16	4
15.0	3	□	MNS1500S-DIN	42.2	64.7	65.7	114.7	112	2.7	16	4
	3	□	MNS1500S-DIN-C	42.2	64.7	65.7	114.7	112	2.7	16	3
	5	□	MNS1500L-DIN	60.2	82.7	83.7	132.7	130	2.7	16	4
	5	●	MNS1500L-DIN-C	60.2	82.7	83.7	132.7	130	2.7	16	3
15.1	3	□	MNS1510S-DIN	42.1	64.7	65.7	114.7	112	2.7	16	4
	3	□	MNS1510S-DIN-C	42.1	64.7	65.7	114.7	112	2.7	16	3
	5	□	MNS1510L-DIN	60.1	82.7	83.7	132.7	130	2.7	16	4
15.2	3	□	MNS1520S-DIN	42.0	64.8	65.8	114.8	112	2.8	16	4
	3	□	MNS1520S-DIN-C	42.0	64.8	65.8	114.8	112	2.8	16	3
	5	□	MNS1520L-DIN	60.0	82.8	83.8	132.8	130	2.8	16	4
	5	□	MNS1520L-DIN-C	60.0	82.8	83.8	132.8	130	2.8	16	3

WIERCENIE (WIERTŁA PEŁNOWĘGLIKOWE)

MNS

WĘGLIKI
SPIEKANE

WIERCENIE

M

DC (mm)	Głębokość otworu (L/D)	TF15	Numer zamówieniowy	Wymiary (mm)							Typ
				LU	LCF	LH	OAL	LF	PL	DCON	
15.3	3	<input type="checkbox"/>	MNS1530S-DIN	41.8	64.8	65.8	114.8	112	2.8	16	4
	3	<input type="checkbox"/>	MNS1530S-DIN-C	41.8	64.8	65.8	114.8	112	2.8	16	3
	5	<input type="checkbox"/>	MNS1530L-DIN	59.8	82.8	83.8	132.8	130	2.8	16	4
	5	<input type="checkbox"/>	MNS1530L-DIN-C	59.8	82.8	83.8	132.8	130	2.8	16	3
15.4	3	<input type="checkbox"/>	MNS1540S-DIN	41.7	64.8	65.8	114.8	112	2.8	16	4
	3	<input type="checkbox"/>	MNS1540S-DIN-C	41.7	64.8	65.8	114.8	112	2.8	16	3
	5	<input type="checkbox"/>	MNS1540L-DIN	59.7	82.8	83.8	132.8	130	2.8	16	4
	5	<input type="checkbox"/>	MNS1540L-DIN-C	59.7	82.8	83.8	132.8	130	2.8	16	3
15.5	3	<input type="checkbox"/>	MNS1550S-DIN	41.6	64.8	65.8	114.8	112	2.8	16	4
	3	<input type="checkbox"/>	MNS1550S-DIN-C	41.6	64.8	65.8	114.8	112	2.8	16	3
	5	<input type="checkbox"/>	MNS1550L-DIN	59.6	82.8	83.8	132.8	130	2.8	16	4
	5	<input checked="" type="checkbox"/>	MNS1550L-DIN-C	59.6	82.8	83.8	132.8	130	2.8	16	3
15.6	3	<input type="checkbox"/>	MNS1560S-DIN	41.4	64.8	65.8	114.8	112	2.8	16	4
	3	<input type="checkbox"/>	MNS1560S-DIN-C	41.4	64.8	65.8	114.8	112	2.8	16	3
	5	<input type="checkbox"/>	MNS1560L-DIN	59.4	82.8	83.8	132.8	130	2.8	16	4
	5	<input type="checkbox"/>	MNS1560L-DIN-C	59.4	82.8	83.8	132.8	130	2.8	16	3
15.7	3	<input type="checkbox"/>	MNS1570S-DIN	41.3	64.9	65.9	114.9	112	2.9	16	4
	3	<input type="checkbox"/>	MNS1570S-DIN-C	41.3	64.9	65.9	114.9	112	2.9	16	3
	5	<input type="checkbox"/>	MNS1570L-DIN	59.3	82.9	83.9	132.9	130	2.9	16	4
	5	<input type="checkbox"/>	MNS1570L-DIN-C	59.3	82.9	83.9	132.9	130	2.9	16	3
15.8	3	<input type="checkbox"/>	MNS1580S-DIN	41.2	64.9	65.9	114.9	112	2.9	16	4
	3	<input type="checkbox"/>	MNS1580S-DIN-C	41.2	64.9	65.9	114.9	112	2.9	16	3
	5	<input type="checkbox"/>	MNS1580L-DIN	59.2	82.9	83.9	132.9	130	2.9	16	4
	5	<input type="checkbox"/>	MNS1580L-DIN-C	59.2	82.9	83.9	132.9	130	2.9	16	3
15.9	3	<input type="checkbox"/>	MNS1590S-DIN	41.0	64.9	65.9	114.9	112	2.9	16	4
	3	<input type="checkbox"/>	MNS1590S-DIN-C	41.0	64.9	65.9	114.9	112	2.9	16	3
	5	<input type="checkbox"/>	MNS1590L-DIN	59.0	82.9	83.9	132.9	130	2.9	16	4
	5	<input type="checkbox"/>	MNS1590L-DIN-C	59.0	82.9	83.9	132.9	130	2.9	16	3
16.0	3	<input type="checkbox"/>	MNS1600S-DIN	40.9	64.9	65.9	114.9	112	2.9	16	4
	3	<input type="checkbox"/>	MNS1600S-DIN-C	40.9	64.9	65.9	114.9	112	2.9	16	3
	5	<input type="checkbox"/>	MNS1600L-DIN	58.9	82.9	83.9	132.9	130	2.9	16	4
	5	<input checked="" type="checkbox"/>	MNS1600L-DIN-C	58.9	82.9	83.9	132.9	130	2.9	16	3
16.1	3	<input type="checkbox"/>	MNS1610S-DIN	48.8	72.9	73.9	122.9	120	2.9	18	4
	3	<input type="checkbox"/>	MNS1610S-DIN-C	48.8	72.9	73.9	122.9	120	2.9	18	3
	5	<input type="checkbox"/>	MNS1610L-DIN	68.8	92.9	93.9	142.9	140	2.9	18	4
	5	<input type="checkbox"/>	MNS1610L-DIN-C	68.8	92.9	93.9	142.9	140	2.9	18	3
16.2	3	<input type="checkbox"/>	MNS1620S-DIN	48.6	72.9	73.9	122.9	120	2.9	18	4
	3	<input type="checkbox"/>	MNS1620S-DIN-C	48.6	72.9	73.9	122.9	120	2.9	18	3
	5	<input type="checkbox"/>	MNS1620L-DIN	68.6	92.9	93.9	142.9	140	2.9	18	4
	5	<input type="checkbox"/>	MNS1620L-DIN-C	68.6	92.9	93.9	142.9	140	2.9	18	3
16.3	3	<input type="checkbox"/>	MNS1630S-DIN	48.5	73.0	74.0	123.0	120	3.0	18	4
	3	<input type="checkbox"/>	MNS1630S-DIN-C	48.5	73.0	74.0	123.0	120	3.0	18	3
	5	<input type="checkbox"/>	MNS1630L-DIN	68.5	93.0	94.0	143.0	140	3.0	18	4
	5	<input type="checkbox"/>	MNS1630L-DIN-C	68.5	93.0	94.0	143.0	140	3.0	18	3
16.4	3	<input type="checkbox"/>	MNS1640S-DIN	48.4	73.0	74.0	123.0	120	3.0	18	4
	3	<input type="checkbox"/>	MNS1640S-DIN-C	48.4	73.0	74.0	123.0	120	3.0	18	3
	5	<input type="checkbox"/>	MNS1640L-DIN	68.4	93.0	94.0	143.0	140	3.0	18	4
	5	<input type="checkbox"/>	MNS1640L-DIN-C	68.4	93.0	94.0	143.0	140	3.0	18	3

DC (mm)	Głębokość otworu (L/D)	TF15	Numer zamówieniowy	Wymiary (mm)							Typ
				LU	LCF	LH	OAL	LF	PL	DCON	
16.5	3	<input type="checkbox"/>	MNS1650S-DIN	48.3	73.0	74.0	123.0	120	3.0	18	4
	3	<input type="checkbox"/>	MNS1650S-DIN-C	48.3	73.0	74.0	123.0	120	3.0	18	3
	5	<input type="checkbox"/>	MNS1650L-DIN	68.3	93.0	94.0	143.0	140	3.0	18	4
	5	<input checked="" type="checkbox"/>	MNS1650L-DIN-C	68.3	93.0	94.0	143.0	140	3.0	18	3
16.6	3	<input type="checkbox"/>	MNS1660S-DIN	48.1	73.0	74.0	123.0	120	3.0	18	4
	3	<input type="checkbox"/>	MNS1660S-DIN-C	48.1	73.0	74.0	123.0	120	3.0	18	3
	5	<input type="checkbox"/>	MNS1660L-DIN	68.1	93.0	94.0	143.0	140	3.0	18	4
	5	<input type="checkbox"/>	MNS1660L-DIN-C	68.1	93.0	94.0	143.0	140	3.0	18	3
16.7	3	<input type="checkbox"/>	MNS1670S-DIN	48.0	73.0	74.0	123.0	120	3.0	18	4
	3	<input type="checkbox"/>	MNS1670S-DIN-C	48.0	73.0	74.0	123.0	120	3.0	18	3
	5	<input type="checkbox"/>	MNS1670L-DIN	68.0	93.0	94.0	143.0	140	3.0	18	4
	5	<input type="checkbox"/>	MNS1670L-DIN-C	68.0	93.0	94.0	143.0	140	3.0	18	3
16.8	3	<input type="checkbox"/>	MNS1680S-DIN	47.9	73.1	74.1	123.1	120	3.1	18	4
	3	<input type="checkbox"/>	MNS1680S-DIN-C	47.9	73.1	74.1	123.1	120	3.1	18	3
	5	<input type="checkbox"/>	MNS1680L-DIN	67.9	93.1	94.1	143.1	140	3.1	18	4
	5	<input type="checkbox"/>	MNS1680L-DIN-C	67.9	93.1	94.1	143.1	140	3.1	18	3
16.9	3	<input type="checkbox"/>	MNS1690S-DIN	47.7	73.1	74.1	123.1	120	3.1	18	4
	3	<input type="checkbox"/>	MNS1690S-DIN-C	47.7	73.1	74.1	123.1	120	3.1	18	3
	5	<input type="checkbox"/>	MNS1690L-DIN	67.7	93.1	94.1	143.1	140	3.1	18	4
	5	<input type="checkbox"/>	MNS1690L-DIN-C	67.7	93.1	94.1	143.1	140	3.1	18	3
17.0	3	<input type="checkbox"/>	MNS1700S-DIN	47.6	73.1	74.1	123.1	120	3.1	18	4
	3	<input type="checkbox"/>	MNS1700S-DIN-C	47.6	73.1	74.1	123.1	120	3.1	18	3
	5	<input type="checkbox"/>	MNS1700L-DIN	67.6	93.1	94.1	143.1	140	3.1	18	4
	5	<input checked="" type="checkbox"/>	MNS1700L-DIN-C	67.6	93.1	94.1	143.1	140	3.1	18	3
17.1	3	<input type="checkbox"/>	MNS1710S-DIN	47.5	73.1	74.1	123.1	120	3.1	18	4
	3	<input type="checkbox"/>	MNS1710S-DIN-C	47.5	73.1	74.1	123.1	120	3.1	18	3
	5	<input type="checkbox"/>	MNS1710L-DIN	67.5	93.1	94.1	143.1	140	3.1	18	4
	5	<input type="checkbox"/>	MNS1710L-DIN-C	67.5	93.1	94.1	143.1	140	3.1	18	3
17.2	3	<input type="checkbox"/>	MNS1720S-DIN	47.3	73.1	74.1	123.1	120	3.1	18	4
	3	<input type="checkbox"/>	MNS1720S-DIN-C	47.3	73.1	74.1	123.1	120	3.1	18	3
	5	<input type="checkbox"/>	MNS1720L-DIN	67.3	93.1	94.1	143.1	140	3.1	18	4
	5	<input type="checkbox"/>	MNS1720L-DIN-C	67.3	93.1	94.1	143.1	140	3.1	18	3
17.3	3	<input type="checkbox"/>	MNS1730S-DIN	47.2	73.1	74.1	123.1	120	3.1	18	4
	3	<input type="checkbox"/>	MNS1730S-DIN-C	47.2	73.1	74.1	123.1	120	3.1	18	3
	5	<input type="checkbox"/>	MNS1730L-DIN	67.2	93.1	94.1	143.1	140	3.1	18	4
	5	<input type="checkbox"/>	MNS1730L-DIN-C	67.2	93.1	94.1	143.1	140	3.1	18	3
17.4	3	<input type="checkbox"/>	MNS1740S-DIN	47.1	73.2	74.2	123.2	120	3.2	18	4
	3	<input type="checkbox"/>	MNS1740S-DIN-C	47.1	73.2	74.2	123.2	120	3.2	18	3
	5	<input type="checkbox"/>	MNS1740L-DIN	67.1	93.2	94.2	143.2	140	3.2	18	4
	5	<input type="checkbox"/>	MNS1740L-DIN-C	67.1	93.2	94.2	143.2	140	3.2	18	3
17.5	3	<input type="checkbox"/>	MNS1750S-DIN	46.9	73.2	74.2	123.2	120	3.2	18	4
	3	<input type="checkbox"/>	MNS1750S-DIN-C	46.9	73.2	74.2	123.2	120	3.2	18	3
	5	<input type="checkbox"/>	MNS1750L-DIN	66.9	93.2	94.2	143.2	140	3.2	18	4
	5	<input checked="" type="checkbox"/>	MNS1750L-DIN-C	66.9	93.2	94.2	143.2	140	3.2	18	3
17.6	3	<input type="checkbox"/>	MNS1760S-DIN	46.8	73.2	74.2	123.2	120	3.2	18	4
	3	<input type="checkbox"/>	MNS1760S-DIN-C	46.8	73.2	74.2	123.2	120	3.2	18	3
	5	<input type="checkbox"/>	MNS1760L-DIN	66.8	93.2	94.2	143.2	140	3.2	18	4
	5	<input type="checkbox"/>	MNS1760L-DIN-C	66.8	93.2	94.2	143.2	140	3.2	18	3

Uwaga 1) Gdy geometria wiertła nie odpowiada wartościom podanym w tabeli (np. inna średnica i długość wiertła), prosimy o skontaktowanie się z naszą firmą.

● : Standard magazynowy. □ : Niestandardowy, produkowany na specjalne zamówienie.

DC (mm)	Głębokość otworu (L/D)	TF15	Numer zamówieniowy	Wymiary (mm)							Typ
				LU	LCF	LH	OAL	LF	PL	DCON	
17.7	3	<input type="checkbox"/>	MNS1770S-DIN	46.7	73.2	74.2	123.2	120	3.2	18	4
	3	<input type="checkbox"/>	MNS1770S-DIN-C	46.7	73.2	74.2	123.2	120	3.2	18	3
	5	<input type="checkbox"/>	MNS1770L-DIN	66.7	93.2	94.2	143.2	140	3.2	18	4
	5	<input type="checkbox"/>	MNS1770L-DIN-C	66.7	93.2	94.2	143.2	140	3.2	18	3
17.8	3	<input type="checkbox"/>	MNS1780S-DIN	46.5	73.2	74.2	123.2	120	3.2	18	4
	3	<input type="checkbox"/>	MNS1780S-DIN-C	46.5	73.2	74.2	123.2	120	3.2	18	3
	5	<input type="checkbox"/>	MNS1780L-DIN	66.5	93.2	94.2	143.2	140	3.2	18	4
	5	<input type="checkbox"/>	MNS1780L-DIN-C	66.5	93.2	94.2	143.2	140	3.2	18	3
17.9	3	<input type="checkbox"/>	MNS1790S-DIN	46.4	73.3	74.3	123.3	120	3.3	18	4
	3	<input type="checkbox"/>	MNS1790S-DIN-C	46.4	73.3	74.3	123.3	120	3.3	18	3
	5	<input type="checkbox"/>	MNS1790L-DIN	66.4	93.3	94.3	143.3	140	3.3	18	4
	5	<input type="checkbox"/>	MNS1790L-DIN-C	66.4	93.3	94.3	143.3	140	3.3	18	3
18.0	3	<input type="checkbox"/>	MNS1800S-DIN	46.3	73.3	74.3	123.3	120	3.3	18	4
	3	<input type="checkbox"/>	MNS1800S-DIN-C	46.3	73.3	74.3	123.3	120	3.3	18	3
	5	<input type="checkbox"/>	MNS1800L-DIN	66.3	93.3	94.3	143.3	140	3.3	18	4
	5	<input checked="" type="checkbox"/>	MNS1800L-DIN-C	66.3	93.3	94.3	143.3	140	3.3	18	3
18.1	3	<input type="checkbox"/>	MNS1810S-DIN	52.1	79.3	80.3	131.3	128	3.3	20	4
	3	<input type="checkbox"/>	MNS1810S-DIN-C	52.1	79.3	80.3	131.3	128	3.3	20	3
	5	<input type="checkbox"/>	MNS1810L-DIN	74.1	101.3	102.3	153.3	150	3.3	20	4
	5	<input type="checkbox"/>	MNS1810L-DIN-C	74.1	101.3	102.3	153.3	150	3.3	20	3
18.2	3	<input type="checkbox"/>	MNS1820S-DIN	52.0	79.3	80.3	131.3	128	3.3	20	4
	3	<input type="checkbox"/>	MNS1820S-DIN-C	52.0	79.3	80.3	131.3	128	3.3	20	3
	5	<input type="checkbox"/>	MNS1820L-DIN	74.0	101.3	102.3	153.3	150	3.3	20	4
	5	<input type="checkbox"/>	MNS1820L-DIN-C	74.0	101.3	102.3	153.3	150	3.3	20	3
18.3	3	<input type="checkbox"/>	MNS1830S-DIN	51.9	79.3	80.3	131.3	128	3.3	20	4
	3	<input type="checkbox"/>	MNS1830S-DIN-C	51.9	79.3	80.3	131.3	128	3.3	20	3
	5	<input type="checkbox"/>	MNS1830L-DIN	73.9	101.3	102.3	153.3	150	3.3	20	4
	5	<input type="checkbox"/>	MNS1830L-DIN-C	73.9	101.3	102.3	153.3	150	3.3	20	3
18.4	3	<input type="checkbox"/>	MNS1840S-DIN	51.7	79.3	80.3	131.3	128	3.3	20	4
	3	<input type="checkbox"/>	MNS1840S-DIN-C	51.7	79.3	80.3	131.3	128	3.3	20	3
	5	<input type="checkbox"/>	MNS1840L-DIN	73.7	101.3	102.3	153.3	150	3.3	20	4
	5	<input type="checkbox"/>	MNS1840L-DIN-C	73.7	101.3	102.3	153.3	150	3.3	20	3
18.5	3	<input type="checkbox"/>	MNS1850S-DIN	51.6	79.4	80.4	131.4	128	3.4	20	4
	3	<input type="checkbox"/>	MNS1850S-DIN-C	51.6	79.4	80.4	131.4	128	3.4	20	3
	5	<input type="checkbox"/>	MNS1850L-DIN	73.6	101.4	102.4	153.4	150	3.4	20	4
	5	<input checked="" type="checkbox"/>	MNS1850L-DIN-C	73.6	101.4	102.4	153.4	150	3.4	20	3
18.6	3	<input type="checkbox"/>	MNS1860S-DIN	51.5	79.4	80.4	131.4	128	3.4	20	4
	3	<input type="checkbox"/>	MNS1860S-DIN-C	51.5	79.4	80.4	131.4	128	3.4	20	3
	5	<input type="checkbox"/>	MNS1860L-DIN	73.5	101.4	102.4	153.4	150	3.4	20	4
	5	<input type="checkbox"/>	MNS1860L-DIN-C	73.5	101.4	102.4	153.4	150	3.4	20	3
18.7	3	<input type="checkbox"/>	MNS1870S-DIN	51.4	79.4	80.4	131.4	128	3.4	20	4
	3	<input type="checkbox"/>	MNS1870S-DIN-C	51.4	79.4	80.4	131.4	128	3.4	20	3
	5	<input type="checkbox"/>	MNS1870L-DIN	73.4	101.4	102.4	153.4	150	3.4	20	4
	5	<input type="checkbox"/>	MNS1870L-DIN-C	73.4	101.4	102.4	153.4	150	3.4	20	3
18.8	3	<input type="checkbox"/>	MNS1880S-DIN	51.2	79.4	80.4	131.4	128	3.4	20	4
	3	<input type="checkbox"/>	MNS1880S-DIN-C	51.2	79.4	80.4	131.4	128	3.4	20	3
	5	<input type="checkbox"/>	MNS1880L-DIN	73.2	101.4	102.4	153.4	150	3.4	20	4
	5	<input type="checkbox"/>	MNS1880L-DIN-C	73.2	101.4	102.4	153.4	150	3.4	20	3

DC (mm)	Głębokość otworu (L/D)	TF15	Numer zamówieniowy	Wymiary (mm)							Typ
				LU	LCF	LH	OAL	LF	PL	DCON	
18.9	3	<input type="checkbox"/>	MNS1890S-DIN	51.1	79.4	80.4	131.4	128	3.4	20	4
	3	<input type="checkbox"/>	MNS1890S-DIN-C	51.1	79.4	80.4	131.4	128	3.4	20	3
	5	<input type="checkbox"/>	MNS1890L-DIN	73.1	101.4	102.4	153.4	150	3.4	20	4
	5	<input type="checkbox"/>	MNS1890L-DIN-C	73.1	101.4	102.4	153.4	150	3.4	20	3
19.0	3	<input type="checkbox"/>	MNS1900S-DIN	51.0	79.5	80.5	131.5	128	3.5	20	4
	3	<input type="checkbox"/>	MNS1900S-DIN-C	51.0	79.5	80.5	131.5	128	3.5	20	3
	5	<input type="checkbox"/>	MNS1900L-DIN	73.0	101.5	102.5	153.5	150	3.5	20	4
	5	<input type="checkbox"/>	MNS1900L-DIN-C	73.0	101.5	102.5	153.5	150	3.5	20	3
19.1	3	<input type="checkbox"/>	MNS1910S-DIN	50.8	79.5	80.5	131.5	128	3.5	20	4
	3	<input type="checkbox"/>	MNS1910S-DIN-C	50.8	79.5	80.5	131.5	128	3.5	20	3
	5	<input type="checkbox"/>	MNS1910L-DIN	72.8	101.5	102.5	153.5	150	3.5	20	4
	5	<input type="checkbox"/>	MNS1910L-DIN-C	72.8	101.5	102.5	153.5	150	3.5	20	3
19.2	3	<input type="checkbox"/>	MNS1920S-DIN	50.7	79.5	80.5	131.5	128	3.5	20	4
	3	<input type="checkbox"/>	MNS1920S-DIN-C	50.7	79.5	80.5	131.5	128	3.5	20	3
	5	<input type="checkbox"/>	MNS1920L-DIN	72.7	101.5	102.5	153.5	150	3.5	20	4
	5	<input type="checkbox"/>	MNS1920L-DIN-C	72.7	101.5	102.5	153.5	150	3.5	20	3
19.3	3	<input type="checkbox"/>	MNS1930S-DIN	50.6	79.5	80.5	131.5	128	3.5	20	4
	5	<input type="checkbox"/>	MNS1930L-DIN	72.6	101.5	102.5	153.5	150	3.5	20	4
	5	<input type="checkbox"/>	MNS1930L-DIN-C	72.6	101.5	102.5	153.5	150	3.5	20	3
	19.4	3	<input type="checkbox"/>	MNS1940S-DIN	50.4	79.5	80.5	131.5	128	3.5	20
3		<input type="checkbox"/>	MNS1940S-DIN-C	50.4	79.5	80.5	131.5	128	3.5	20	3
5		<input type="checkbox"/>	MNS1940L-DIN	72.4	101.5	102.5	153.5	150	3.5	20	4
5		<input type="checkbox"/>	MNS1940L-DIN-C	72.4	101.5	102.5	153.5	150	3.5	20	3
19.5	3	<input type="checkbox"/>	MNS1950S-DIN	50.3	79.5	80.5	131.5	128	3.5	20	4
	3	<input type="checkbox"/>	MNS1950S-DIN-C	50.3	79.5	80.5	131.5	128	3.5	20	3
	5	<input type="checkbox"/>	MNS1950L-DIN	72.3	101.5	102.5	153.5	150	3.5	20	4
	5	<input checked="" type="checkbox"/>	MNS1950L-DIN-C	72.3	101.5	102.5	153.5	150	3.5	20	3
19.6	3	<input type="checkbox"/>	MNS1960S-DIN	50.2	79.6	80.6	131.6	128	3.6	20	4
	3	<input type="checkbox"/>	MNS1960S-DIN-C	50.2	79.6	80.6	131.6	128	3.6	20	3
	5	<input type="checkbox"/>	MNS1960L-DIN	72.2	101.6	102.6	153.6	150	3.6	20	4
	5	<input type="checkbox"/>	MNS1960L-DIN-C	72.2	101.6	102.6	153.6	150	3.6	20	3
19.7	3	<input type="checkbox"/>	MNS1970S-DIN	50.0	79.6	80.6	131.6	128	3.6	20	4
	3	<input type="checkbox"/>	MNS1970S-DIN-C	50.0	79.6	80.6	131.6	128	3.6	20	3
	5	<input type="checkbox"/>	MNS1970L-DIN	72.0	101.6	102.6	153.6	150	3.6	20	4
	5	<input type="checkbox"/>	MNS1970L-DIN-C	72.0	101.6	102.6	153.6	150	3.6	20	3
19.8	3	<input type="checkbox"/>	MNS1980S-DIN	49.9	79.6	80.6	131.6	128	3.6	20	4
	3	<input type="checkbox"/>	MNS1980S-DIN-C	49.9	79.6	80.6	131.6	128	3.6	20	3
	5	<input type="checkbox"/>	MNS1980L-DIN	71.9	101.6	102.6	153.6	150	3.6	20	4
	5	<input type="checkbox"/>	MNS1980L-DIN-C	71.9	101.6	102.6	153.6	150	3.6	20	3
19.9	3	<input type="checkbox"/>	MNS1990S-DIN	49.8	79.6	80.6	131.6	128	3.6	20	4
	3	<input type="checkbox"/>	MNS1990S-DIN-C	49.8	79.6	80.6	131.6	128	3.6	20	3
	5	<input type="checkbox"/>	MNS1990L-DIN	71.8	101.6	102.6	153.6	150	3.6	20	4
	5	<input type="checkbox"/>	MNS1990L-DIN-C	71.8	101.6	102.6	153.6	150	3.6	20	3
20.0	3	<input type="checkbox"/>	MNS2000S-DIN	49.6	79.6	80.6	131.6	128	3.6	20	4
	3	<input type="checkbox"/>	MNS2000S-DIN-C	49.6	79.6	80.6	131.6	128	3.6	20	3
	5	<input type="checkbox"/>	MNS2000L-DIN	71.6	101.6	102.6	153.6	150	3.6	20	4
	5	<input checked="" type="checkbox"/>	MNS2000L-DIN-C	71.6	101.6	102.6	153.6	150	3.6	20	3

ZALECANE PARAMETRY SKRAWANIA

■ Głębokość otworu : L/D = 3, 5, 8 (Wiertła typu LB, S-DIN, S-DIN-C, L-DIN, L-DIN-C, L8C)

Materiał przedmiotu obrabianego	N					
	Stopy aluminium (Si<5%)		Stopy aluminium (5%≤Si≤10%)		Stopy aluminium (Si>10%)	
Średnica wiertła DC (mm)	Obroty (min ⁻¹)	Posuw (min. – maks.) (mm/obr.)	Obroty (min ⁻¹)	Posuw (min. – maks.) (mm/obr.)	Obroty (min ⁻¹)	Posuw (min. – maks.) (mm/obr.)
3.2	11900	0.1 (0.11–0.16)	11900	0.15 (0.16–0.21)	11900	0.15 (0.16–0.21)
4.0	9500	0.15 (0.13–0.20)	9500	0.2 (0.20–0.27)	9500	0.2 (0.20–0.27)
5.0	7600	0.2 (0.17–0.25)	7600	0.25 (0.25–0.33)	7600	0.25 (0.25–0.33)
6.3	7500	0.25 (0.21–0.32)	7500	0.35 (0.32–0.42)	7500	0.35 (0.32–0.42)
8.0	5900	0.3 (0.27–0.40)	5900	0.45 (0.40–0.53)	5900	0.45 (0.40–0.53)
10.0	4700	0.4 (0.33–0.50)	4700	0.55 (0.50–0.67)	4700	0.55 (0.50–0.67)
12.0	5300	0.5 (0.40–0.60)	5300	0.7 (0.60–0.80)	5300	0.7 (0.60–0.80)
14.0	4500	0.5 (0.40–0.60)	4500	0.7 (0.60–0.80)	4500	0.7 (0.60–0.80)
16.0	4000	0.5 (0.40–0.60)	4000	0.7 (0.60–0.80)	4000	0.7 (0.60–0.80)
18.0	3500	0.5 (0.40–0.60)	3500	0.7 (0.60–0.80)	3500	0.7 (0.60–0.80)
20.0	3200	0.5 (0.40–0.60)	3200	0.7 (0.60–0.80)	3200	0.7 (0.60–0.80)

Uwaga 1) W przypadku stosowania wiertła o stosunku L/D powyżej 10, wykonać otwory pilotowe.

(bez otworu pilotowego wiertło może złamać się.)

Uwaga 2) Do wiercenia otworu prowadzącego zaleca się użycie wiertła MNS, MAE-MB albo MAS-MB Mitsubishi.

■ Głębokość otworu : L/D = 10, 12, 15, 20, 25, 30 (Wiertła typu X10DB, X20DB, X30DB, L10C, L12C, L15C, L20C, L25C, L30C)

Materiał przedmiotu obrabianego	N					
	Stopy aluminium (Si<5%)		Stopy aluminium (5%≤Si≤10%)		Stopy aluminium (Si>10%)	
Średnica wiertła DC (mm)	Obroty (min ⁻¹)	Posuw (min. – maks.) (mm/obr.)	Obroty (min ⁻¹)	Posuw (min. – maks.) (mm/obr.)	Obroty (min ⁻¹)	Posuw (min. – maks.) (mm/obr.)
3.2	8900	0.1 (0.11–0.16)	8900	0.15 (0.16–0.21)	8900	0.15 (0.16–0.21)
4.0	7100	0.15 (0.13–0.20)	7100	0.2 (0.20–0.27)	7100	0.2 (0.20–0.27)
5.0	5700	0.2 (0.17–0.25)	5700	0.25 (0.25–0.33)	5700	0.25 (0.25–0.33)
6.3	6000	0.25 (0.21–0.32)	6000	0.35 (0.32–0.42)	6000	0.35 (0.32–0.42)
8.0	4700	0.3 (0.27–0.40)	4700	0.45 (0.40–0.53)	4700	0.45 (0.40–0.53)
10.0	3800	0.4 (0.33–0.50)	3800	0.55 (0.50–0.67)	3800	0.55 (0.50–0.67)
12.0	4200	0.5 (0.40–0.60)	4200	0.7 (0.60–0.80)	4200	0.7 (0.60–0.80)
14.0	3600	0.5 (0.40–0.60)	3600	0.7 (0.60–0.80)	3600	0.7 (0.60–0.80)
16.0	3200	0.5 (0.40–0.60)	3200	0.7 (0.60–0.80)	3200	0.7 (0.60–0.80)
18.0	2800	0.5 (0.40–0.60)	2800	0.7 (0.60–0.80)	2800	0.7 (0.60–0.80)
20.0	2500	0.5 (0.40–0.60)	2500	0.7 (0.60–0.80)	2500	0.7 (0.60–0.80)

Uwaga 1) W przypadku stosowania wiertła o stosunku L/D powyżej 10, wykonać otwory pilotowe.

(bez otworu pilotowego wiertło może złamać się.)

Uwaga 2) Do wiercenia otworu prowadzącego zaleca się użycie wiertła MNS, MAE-MB albo MAS-MB Mitsubishi.

■ WSKAZÓWKI EKSPLOATACYJNE DLA WIERTEŁ TYPU MNS (L/D 3, 5, 8)

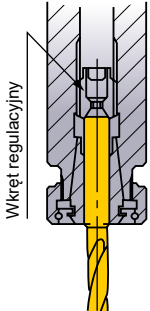
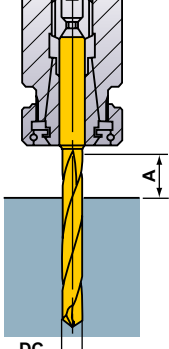
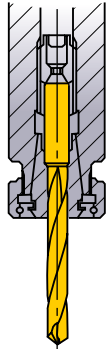
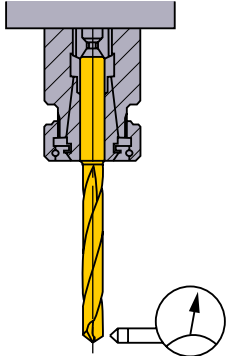
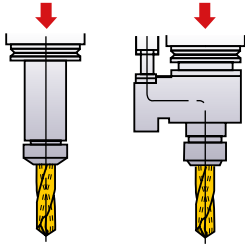
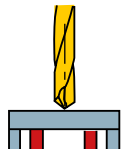
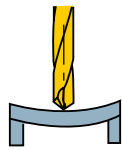
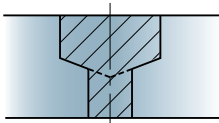
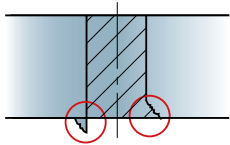
<p>Zamocowanie wiertła</p>  <p>Uchwyt z tuleją wciąganą i łożyskiem oporowym silnie mocuje narzędzie.</p>	<p>Długość wiertła</p>  <p>$A : \geq DC \times 1.5$</p>	<p>Montaż wiertła</p>  <p>Nie mocować wiertła za rowek wiórowy.</p>	<p>Tolerancja montażu</p>  <p>Bicie $\leq 0.03\text{mm}$</p>
<p>Metoda chłodzenia (MNS)</p> <p>Wirzeciona z przelotowym kanałem doprowadzenia chłodziwa</p> <p>Obrabiarka z zewnętrznym doprowadzeniem chłodziwa przez wrzeciono</p>  <p>Ciśnienie chłodziwa wynosi ok. 5 bar – 70 bar</p>	<p>Postępowanie z chłodziwem</p> <p><Typ MNS></p> <ol style="list-style-type: none"> 1) Cząstki brudu i kurzu w używanym chłodziwie zatykają kanał doprowadzenia chłodziwa i uniemożliwiają jego skuteczny przepływ. Zalecana jest regularna wymiana chłodziwa. 2) Małe cząstki opiłków zatykają kanał doprowadzenia chłodziwa. Profilaktycznie zawsze używać filtra. Wierząc wiertłem o małej średnicy, używać filtra o małym numerze sita. 	<p>Cienkie przedmioty obrabiane</p>  <p>OK Umieścić przedmiot obrabiany na podpórcie</p>  <p>X W razie wystąpienia zginania</p>	<p>Obróbka przerywana</p> <p>Proces jednozabiegowy</p> <p>OK</p> <p>① Podczas wiercenia detalu stopniowanego zmniejszyć posuw.</p> <p>Wymaga wstępnego wiercenia</p> <p>① Przed wierceniem wykonać splaszczanie frezem trzpieniowym</p>
<p>Otwory stopniowane</p>  <ol style="list-style-type: none"> ① Podzielić proces obróbki na dwa zabiegi. ② Najpierw wywiercić otwór o większej średnicy. <p>*Narzędzia do fazowania i pogłębiania czołowego mogą być wykonane na zamówienie.</p>	<p>Stępienie ostrych krawędzi i fazowanie przedmiotu obrabianego</p>  <ol style="list-style-type: none"> ① W momencie wyjścia z materiału zmniejszyć posuw. ② Wykonać fazkę. ③ Zmieni kąt wierzchołkowy. 		

■ WSKAZÓWKI EKSPLOATACYJNE DLA WIERTEŁ DŁUGICH TYPU MNS (L/D 10, 12, 15, 20, 25, 30)

WIERCENIE PRZEDMIOTÓW O PŁASKIEJ POWIERZCHNI CZOŁOWEJ ● Wiercenie otworu nieprzelotowego

■ 1. Wiercenie otworu pilotowego

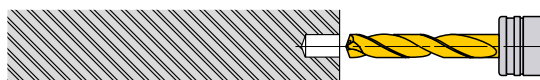

- ① Do otworu pilotowego użyć wiertła Mitsubishi typu MNS, MAE-MB albo MAS-MB.
- ② Zapewnić wykonanie wysokodokładnego otworu pilotowego, aby proces wiercenia głębokich otworów przebiegał bezusterkowo.
- ③ Głębokość wiercenia otworu pilotowego: ok. 1DC albo większa. (Głębokość otworu pilotowego dostosować do długości wiertła.)

■ 2. Wiercenie wstępne wiertłem długim



- ① Wiercić wstępnie otwór pilotowy przy małych obrotach. (prędkość skrawania 20–30m/min, posuw 0.2–0.3mm/obr)
- ② Zakończyć wiercenie wiertłem do głębokich otworów na 1–3mm przed dnem otworu pilotowego.

■ 3. Wiercić głęboki otwór

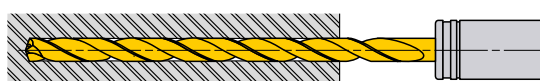

- ① Zwiększyć obroty i posuw w jednym cyklu i wiercić, aż do uzyskania żądanej głębokości otworu.

■ 4. Wycofanie wiertła

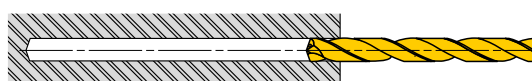

- ① Po wierceniu zmniejszyć obroty na 1–2mm przed końcem otworu. (prędkość skrawania ok. 20–30m/min)
- ② Wycofać wiertło na głębokość początkową otworu pilotowego przy prędkości posuwu 3000mm/min.
- ③ Wycofać wiertło z otworu pilotowego przy obrotach ($n=300$, $V_f=3000$ mm/min.)

WIERCENIE PRZERYWANE ● Wiercenie otworów w płaszczyznach nieregularnych lub pod kątem

■ 1. Frezowanie płaszczyzn

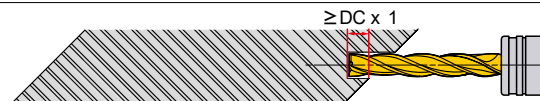

- ① Przy wierceniu otworów głębokich na powierzchni skośnej użyć wiertła MFE do wywiercenia otworu prowadzącego.
- ② Zapewnić, aby otwór prowadzący wykonany był z dużą dokładnością.
- ③ Głębokość wiercenia otworu pilotowego: ok. $DC \times 1$.

■ 2. Wiercenie otworu pilotowego

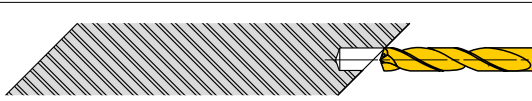

- ① Do otworu pilotowego użyć wiertła Mitsubishi typu MNS, MAE-MB albo MAS-MB.
- ② Zapewnić wykonanie wysokodokładnego otworu pilotowego, aby proces wiercenia głębokich otworów przebiegał bezusterkowo.
- ③ Głębokość wiercenia otworu pilotowego: ok. 1DC albo większa. (Głębokość otworu pilotowego dostosować do długości wiertła.)

■ 3. Wiercenie wstępne wiertłem długim



- ① Wprowadzić wiertło w otwór pilotowy przy małych obrotach (prędkość skrawania 20–30m/min, posuw 0,2–0,3 mm/obr).
- ② Zatrzymać wiertło 1mm–3 mm przed dnem otworu pilotowego.

■ 4. Wiercić głęboki otwór

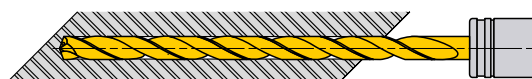

- ① Zwiększyć obroty i posuw w jednym cyklu i wiercić, aż do uzyskania żądanej głębokości otworu.

■ 5. Wyjście z materiału

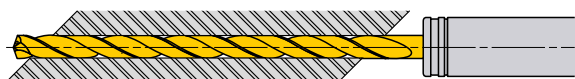

- ① Podczas wychodzenia z materiału istnieje niebezpieczeństwo uszkodzenia krawędzi skrawającej wiertła.
- ② Zaleca się zmniejszenie posuwu do 0.05mm–0.1mm/obr.

■ 6. Wycofanie wiertła



- ① Wycofać wiertło do punktu początkowego otworu pilotowego przy prędkości posuwu 3000mm/min.

WIERCENIE (WIERTŁA PEŁNOWĘGLIKOWE)

MAE, MAS

- Wiertło specjalne do obróbki aluminium i żeliwa.
- Podwyższona tolerancja otworu.
- Nawiercanie otworu pod gwint walcowany.
- Spiralny kanał doprowadzenia chłodziwa umożliwia wiercenie szybkościowe (wierćło typu MAS).



Tylko MAS



MAE (Chłodzenie zewnętrzne)



MAS (Chłodzenie wewnętrzne)



Uwaga 1) Wiertła typu MAS o średnicy powyżej $\phi 5.0$ posiadają opuszczenie w części czolowej.

Uwaga 2) Wiertła MAE/MAS z oprawkami termokurczliwymi.



DC=3	3<DC≤6	6<DC≤10	10<DC≤16
+0.005 0	+0.005 0	+0.005 0	+0.005 0
0 -0.006	0 -0.008	0 -0.009	0 -0.011

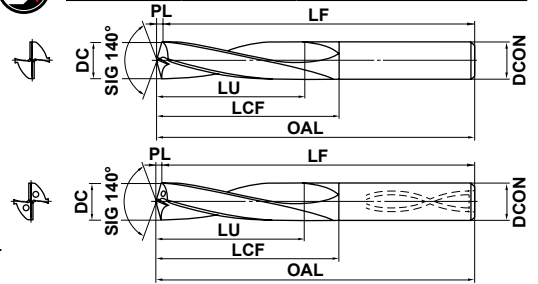

DC (mm)	Głębokość otworu (L/D)	Chłodzenie (Wewn./Zewn.)	HT110	Numer zamówieniowy	Wymiary (mm)					
					LU	LCF	OAL	LF	PL	DCON
3.0	3	Zewn.	★	MAE0300MB	9.5	21.5	61.5	61	0.5	3
	3	Wewn.	□	MAS0300MB	9.5	21.5	61.5	61	0.5	3
	6	Wewn.	●	MAS0300LB	18.5	30.5	70.5	70	0.5	3
3.1	3	Zewn.	★	MAE0310MB	9.9	24.6	64.6	64	0.6	4
	3	Wewn.	□	MAS0310MB	9.9	24.6	64.6	64	0.6	4
	6	Wewn.	★	MAS0310LB	19.2	34.6	74.6	74	0.6	4
3.2	3	Zewn.	★	MAE0320MB	10.2	24.6	64.6	64	0.6	4
	3	Wewn.	□	MAS0320MB	10.2	24.6	64.6	64	0.6	4
	6	Wewn.	★	MAS0320LB	19.8	34.6	74.6	74	0.6	4
3.3	3	Zewn.	★	MAE0330MB	10.5	24.6	64.6	64	0.6	4
	3	Wewn.	□	MAS0330MB	10.5	24.6	64.6	64	0.6	4
	6	Wewn.	●	MAS0330LB	20.4	34.6	74.6	74	0.6	4
3.4	3	Zewn.	★	MAE0340MB	10.8	24.6	64.6	64	0.6	4
	3	Wewn.	□	MAS0340MB	10.8	24.6	64.6	64	0.6	4
	6	Wewn.	★	MAS0340LB	21.0	34.6	74.6	74	0.6	4
3.5	3	Zewn.	★	MAE0350MB	11.1	24.6	64.6	64	0.6	4
	3	Wewn.	□	MAS0350MB	11.1	24.6	64.6	64	0.6	4
	6	Wewn.	●	MAS0350LB	21.6	34.6	74.6	74	0.6	4
3.6	3	Zewn.	★	MAE0360MB	11.5	28.7	68.7	68	0.7	4
	3	Wewn.	□	MAS0360MB	11.5	28.7	68.7	68	0.7	4
	6	Wewn.	★	MAS0360LB	22.3	40.7	80.7	80	0.7	4
3.65	3	Zewn.	★	* MAE0365MB	11.7	28.7	68.7	68	0.7	4
	3	Wewn.	□	* MAS0365MB	11.7	28.7	68.7	68	0.7	4
	6	Wewn.	●	* MAS0365LB	22.6	40.7	80.7	80	0.7	4
3.7	3	Zewn.	★	MAE0370MB	11.8	28.7	68.7	68	0.7	4
	3	Wewn.	□	MAS0370MB	11.8	28.7	68.7	68	0.7	4
	6	Wewn.	★	MAS0370LB	22.9	40.7	80.7	80	0.7	4
3.8	3	Zewn.	★	MAE0380MB	12.1	28.7	68.7	68	0.7	4
	3	Wewn.	□	MAS0380MB	12.1	28.7	68.7	68	0.7	4
	6	Wewn.	★	MAS0380LB	23.5	40.7	80.7	80	0.7	4
3.9	3	Zewn.	★	MAE0390MB	12.4	28.7	68.7	68	0.7	4
	3	Wewn.	□	MAS0390MB	12.4	28.7	68.7	68	0.7	4
	6	Wewn.	★	MAS0390LB	24.1	40.7	80.7	80	0.7	4
4.0	3	Zewn.	★	MAE0400MB	12.7	28.7	68.7	68	0.7	4
	3	Wewn.	□	MAS0400MB	12.7	28.7	68.7	68	0.7	4
	6	Wewn.	●	MAS0400LB	24.7	40.7	80.7	80	0.7	4
4.1	3	Zewn.	★	MAE0410MB	13.0	31.7	71.7	71	0.7	5
	3	Wewn.	□	MAS0410MB	13.0	31.7	71.7	71	0.7	5
	6	Wewn.	★	MAS0410LB	25.3	44.7	84.7	84	0.7	5

DC (mm)	Głębokość otworu (L/D)	Chłodzenie (Wewn./Zewn.)	HT110	Numer zamówieniowy	Wymiary (mm)					
					LU	LCF	OAL	LF	PL	DCON
4.2	3	Zewn.	★	MAE0420MB	13.4	31.8	71.8	71	0.8	5
	3	Wewn.	□	MAS0420MB	13.4	31.8	71.8	71	0.8	5
	6	Wewn.	●	MAS0420LB	26.0	44.8	84.8	84	0.8	5
4.3	3	Zewn.	★	MAE0430MB	13.7	31.8	71.8	71	0.8	5
	3	Wewn.	□	MAS0430MB	13.7	31.8	71.8	71	0.8	5
	6	Wewn.	★	MAS0430LB	26.6	44.8	84.8	84	0.8	5
4.4	3	Zewn.	★	MAE0440MB	14.0	31.8	71.8	71	0.8	5
	3	Wewn.	□	MAS0440MB	14.0	31.8	71.8	71	0.8	5
	6	Wewn.	★	MAS0440LB	27.2	44.8	84.8	84	0.8	5
4.5	3	Zewn.	★	MAE0450MB	14.3	31.8	71.8	71	0.8	5
	3	Wewn.	□	MAS0450MB	14.3	31.8	71.8	71	0.8	5
	6	Wewn.	★	MAS0450LB	27.8	44.8	84.8	84	0.8	5
4.6	3	Zewn.	★	* MAE0460MB	14.6	33.8	73.8	73	0.8	5
	3	Wewn.	□	* MAS0460MB	14.6	33.8	73.8	73	0.8	5
	6	Wewn.	●	* MAS0460LB	28.4	48.8	88.8	88	0.8	5
4.7	3	Zewn.	★	MAE0470MB	15.0	33.9	73.9	73	0.9	5
	3	Wewn.	□	MAS0470MB	15.0	33.9	73.9	73	0.9	5
	6	Wewn.	★	MAS0470LB	29.1	48.9	88.9	88	0.9	5
4.8	3	Zewn.	★	MAE0480MB	15.3	33.9	73.9	73	0.9	5
	3	Wewn.	□	MAS0480MB	15.3	33.9	73.9	73	0.9	5
	6	Wewn.	★	MAS0480LB	29.7	48.9	88.9	88	0.9	5
4.9	3	Zewn.	★	MAE0490MB	15.6	33.9	73.9	73	0.9	5
	3	Wewn.	□	MAS0490MB	15.6	33.9	73.9	73	0.9	5
	6	Wewn.	★	MAS0490LB	30.3	48.9	88.9	88	0.9	5
5.0	3	Zewn.	★	MAE0500MB	15.9	33.9	73.9	73	0.9	5
	3	Wewn.	●	MAS0500MB	15.9	33.9	73.9	73	0.9	5
	6	Wewn.	●	MAS0500LB	30.9	48.9	88.9	88	0.9	5
5.1	3	Zewn.	★	MAE0510MB	16.2	36.9	76.9	76	0.9	6
	3	Wewn.	□	MAS0510MB	16.2	36.9	76.9	76	0.9	6
	6	Wewn.	★	MAS0510LB	31.5	52.9	92.9	92	0.9	6
5.2	3	Zewn.	★	MAE0520MB	16.5	36.9	76.9	76	0.9	6
	3	Wewn.	□	MAS0520MB	16.5	36.9	76.9	76	0.9	6
	6	Wewn.	●	MAS0520LB	32.1	52.9	92.9	92	0.9	6
5.3	3	Zewn.	★	MAE0530MB	16.9	37.0	77.0	76	1.0	6
	3	Wewn.	□	MAS0530MB	16.9	37.0	77.0	76	1.0	6
	6	Wewn.	★	MAS0530LB	32.8	53.0	93.0	92	1.0	6
5.4	3	Zewn.	★	MAE0540MB	17.2	37.0	77.0	76	1.0	6
	3	Wewn.	□	MAS0540MB	17.2	37.0	77.0	76	1.0	6
	6	Wewn.	★	MAS0540LB	33.4	53.0	93.0	92	1.0	6

* : Znormalizowana średnica otworu pod gwint walcowany.

● : Standard magazynowy. ★ : Na specjalne zamówienie z magazynu w Japonii.

□ : Niestandardowy, produkowany na specjalne zamówienie.

DC (mm)	Głębokość otworu (L/D)	Chłodzenie (Wewn./Zewn.)	HTI10	Numer zamówieniowy	Wymiary (mm)					
					LU	LCF	OAL	LF	PL	DCON
5.5	3	Zewn.	★	* MAE0550MB	17.5	37.0	77.0	76	1.0	6
	3	Wewn.	★	* MAS0550MB	17.5	37.0	77.0	76	1.0	6
	6	Wewn.	●	* MAS0550LB	34.0	53.0	93.0	92	1.0	6
5.6	3	Zewn.	★	MAE0560MB	17.8	40.0	80.0	79	1.0	6
	3	Wewn.	□	MAS0560MB	17.8	40.0	80.0	79	1.0	6
	6	Wewn.	★	MAS0560LB	34.6	58.0	98.0	97	1.0	6
5.7	3	Zewn.	★	MAE0570MB	18.1	40.0	80.0	79	1.0	6
	3	Wewn.	□	MAS0570MB	18.1	40.0	80.0	79	1.0	6
	6	Wewn.	★	MAS0570LB	35.2	58.0	98.0	97	1.0	6
5.8	3	Zewn.	★	MAE0580MB	18.5	40.1	80.1	79	1.1	6
	3	Wewn.	□	MAS0580MB	18.5	40.1	80.1	79	1.1	6
	6	Wewn.	★	MAS0580LB	35.9	58.1	98.1	97	1.1	6
5.9	3	Zewn.	★	MAE0590MB	18.8	40.1	80.1	79	1.1	6
	3	Wewn.	□	MAS0590MB	18.8	40.1	80.1	79	1.1	6
	6	Wewn.	★	MAS0590LB	36.5	58.1	98.1	97	1.1	6
6.0	3	Zewn.	★	MAE0600MB	19.1	40.1	80.1	79	1.1	6
	3	Wewn.	●	MAS0600MB	19.1	40.1	80.1	79	1.1	6
	6	Wewn.	●	MAS0600LB	37.1	58.1	98.1	97	1.1	6
6.1	3	Zewn.	★	MAE0610MB	19.4	43.1	85.1	84	1.1	7
	3	Wewn.	□	MAS0610MB	19.4	43.1	85.1	84	1.1	7
	6	Wewn.	★	MAS0610LB	37.7	63.1	105.1	104	1.1	7
6.2	3	Zewn.	★	MAE0620MB	19.7	43.1	85.1	84	1.1	7
	3	Wewn.	□	MAS0620MB	19.7	43.1	85.1	84	1.1	7
	6	Wewn.	★	MAS0620LB	38.3	63.1	105.1	104	1.1	7
6.3	3	Zewn.	★	MAE0630MB	20.0	43.1	85.1	84	1.1	7
	3	Wewn.	□	MAS0630MB	20.0	43.1	85.1	84	1.1	7
	6	Wewn.	★	MAS0630LB	38.9	63.1	105.1	104	1.1	7
6.4	3	Zewn.	★	MAE0640MB	20.4	43.2	85.2	84	1.2	7
	3	Wewn.	□	MAS0640MB	20.4	43.2	85.2	84	1.2	7
	6	Wewn.	★	MAS0640LB	39.6	63.2	105.2	104	1.2	7
6.5	3	Zewn.	★	MAE0650MB	20.7	43.2	85.2	84	1.2	7
	3	Wewn.	★	MAS0650MB	20.7	43.2	85.2	84	1.2	7
	6	Wewn.	●	MAS0650LB	40.2	63.2	105.2	104	1.2	7
6.6	3	Zewn.	★	MAE0660MB	21.0	43.2	85.2	84	1.2	7
	3	Wewn.	□	MAS0660MB	21.0	43.2	85.2	84	1.2	7
	6	Wewn.	★	MAS0660LB	40.8	66.2	108.2	107	1.2	7
6.7	3	Zewn.	★	MAE0670MB	21.3	43.2	85.2	84	1.2	7
	3	Wewn.	□	MAS0670MB	21.3	43.2	85.2	84	1.2	7
	6	Wewn.	●	MAS0670LB	41.4	66.2	108.2	107	1.2	7
6.8	3	Zewn.	★	MAE0680MB	21.6	43.2	85.2	84	1.2	7
	3	Wewn.	★	MAS0680MB	21.6	43.2	85.2	84	1.2	7
	6	Wewn.	●	MAS0680LB	42.0	66.2	108.2	107	1.2	7
6.9	3	Zewn.	★	MAE0690MB	22.0	43.3	85.3	84	1.3	7
	3	Wewn.	□	MAS0690MB	22.0	43.3	85.3	84	1.3	7
	6	Wewn.	★	MAS0690LB	42.7	66.3	108.3	107	1.3	7
7.0	3	Zewn.	★	MAE0700MB	22.3	43.3	85.3	84	1.3	7
	3	Wewn.	★	MAS0700MB	22.3	43.3	85.3	84	1.3	7
	6	Wewn.	●	MAS0700LB	43.3	66.3	108.3	107	1.3	7

* : Znormalizowana średnica otworu pod gwint walcowany.

DC (mm)	Głębokość otworu (L/D)	Chłodzenie (Wewn./Zewn.)	HTI10	Numer zamówieniowy	Wymiary (mm)					
					LU	LCF	OAL	LF	PL	DCON
7.1	3	Zewn.	★	MAE0710MB	22.6	49.3	91.3	90	1.3	8
	3	Wewn.	□	MAS0710MB	22.6	49.3	91.3	90	1.3	8
	6	Wewn.	★	MAS0710LB	43.9	69.3	111.3	110	1.3	8
7.2	3	Zewn.	★	MAE0720MB	22.9	49.3	91.3	90	1.3	8
	3	Wewn.	□	MAS0720MB	22.9	49.3	91.3	90	1.3	8
	6	Wewn.	★	MAS0720LB	44.5	69.3	111.3	110	1.3	8
7.3	3	Zewn.	★	MAE0730MB	23.2	49.3	91.3	90	1.3	8
	3	Wewn.	□	MAS0730MB	23.2	49.3	91.3	90	1.3	8
	6	Wewn.	★	MAS0730LB	45.1	69.3	111.3	110	1.3	8
7.35	3	Zewn.	★	* MAE0735MB	23.4	49.3	91.3	90	1.3	8
	3	Wewn.	★	* MAS0735MB	23.4	49.3	91.3	90	1.3	8
	6	Wewn.	●	* MAS0735LB	45.4	69.3	111.3	110	1.3	8
7.4	3	Zewn.	★	MAE0740MB	23.5	49.3	91.3	90	1.3	8
	3	Wewn.	□	MAS0740MB	23.5	49.3	91.3	90	1.3	8
	6	Wewn.	★	MAS0740LB	45.7	69.3	111.3	110	1.3	8
7.5	3	Zewn.	★	MAE0750MB	23.9	49.4	91.4	90	1.4	8
	3	Wewn.	□	MAS0750MB	23.9	49.4	91.4	90	1.4	8
	6	Wewn.	★	MAS0750LB	46.4	69.4	111.4	110	1.4	8
7.6	3	Zewn.	★	MAE0760MB	24.2	49.4	91.4	90	1.4	8
	3	Wewn.	□	MAS0760MB	24.2	49.4	91.4	90	1.4	8
	6	Wewn.	★	MAS0760LB	47.0	73.4	115.4	114	1.4	8
7.7	3	Zewn.	★	MAE0770MB	24.5	49.4	91.4	90	1.4	8
	3	Wewn.	□	MAS0770MB	24.5	49.4	91.4	90	1.4	8
	6	Wewn.	★	MAS0770LB	47.6	73.4	115.4	114	1.4	8
7.8	3	Zewn.	★	MAE0780MB	24.8	49.4	91.4	90	1.4	8
	3	Wewn.	□	MAS0780MB	24.8	49.4	91.4	90	1.4	8
	6	Wewn.	★	MAS0780LB	48.2	73.4	115.4	114	1.4	8
7.9	3	Zewn.	★	MAE0790MB	25.1	49.4	91.4	90	1.4	8
	3	Wewn.	□	MAS0790MB	25.1	49.4	91.4	90	1.4	8
	6	Wewn.	★	MAS0790LB	48.8	73.4	115.4	114	1.4	8
8.0	3	Zewn.	★	MAE0800MB	25.5	49.5	91.5	90	1.5	8
	3	Wewn.	●	MAS0800MB	25.5	49.5	91.5	90	1.5	8
	6	Wewn.	●	MAS0800LB	49.5	73.5	115.5	114	1.5	8
8.1	3	Zewn.	★	MAE0810MB	25.8	51.5	95.5	94	1.5	9
	3	Wewn.	□	MAS0810MB	25.8	51.5	95.5	94	1.5	9
	6	Wewn.	★	MAS0810LB	50.1	76.5	120.5	119	1.5	9
8.2	3	Zewn.	★	MAE0820MB	26.1	51.5	95.5	94	1.5	9
	3	Wewn.	□	MAS0820MB	26.1	51.5	95.5	94	1.5	9
	6	Wewn.	★	MAS0820LB	50.7	76.5	120.5	119	1.5	9
8.3	3	Zewn.	★	MAE0830MB	26.4	51.5	95.5	94	1.5	9
	3	Wewn.	□	MAS0830MB	26.4	51.5	95.5	94	1.5	9
	6	Wewn.	★	MAS0830LB	51.3	76.5	120.5	119	1.5	9
8.4	3	Zewn.	★	MAE0840MB	26.7	51.5	95.5	94	1.5	9
	3	Wewn.	□	MAS0840MB	26.7	51.5	95.5	94	1.5	9
	6	Wewn.	★	MAS0840LB	51.9	76.5	120.5	119	1.5	9
8.5	3	Zewn.	★	MAE0850MB	27.0	51.5	95.5	94	1.5	9
	3	Wewn.	●	MAS0850MB	27.0	51.5	95.5	94	1.5	9
	6	Wewn.	★	MAS0850LB	52.5	76.5	120.5	119	1.5	9

MAE,MAS

WĘGLIKI
SPIEKANE

M
WIERCENIE

DC (mm)	Głębokość otworu (L/D)	Chłodzenie (Wewn./Zewn.)	HTI10	Numer zamówieniowy	Wymiary (mm)					
					LU	LCF	OAL	LF	PL	DCON
8.6	3	Zewn.	★	MAE0860MB	27.4	51.6	95.6	94	1.6	9
	3	Wewn.	□	MAS0860MB	27.4	51.6	95.6	94	1.6	9
	6	Wewn.	★	MAS0860LB	53.2	78.6	122.6	121	1.6	9
8.7	3	Zewn.	★	MAE0870MB	27.7	51.6	95.6	94	1.6	9
	3	Wewn.	□	MAS0870MB	27.7	51.6	95.6	94	1.6	9
	6	Wewn.	★	MAS0870LB	53.8	78.6	122.6	121	1.6	9
8.8	3	Zewn.	★	MAE0880MB	28.0	51.6	95.6	94	1.6	9
	3	Wewn.	□	MAS0880MB	28.0	51.6	95.6	94	1.6	9
	6	Wewn.	★	MAS0880LB	54.4	78.6	122.6	121	1.6	9
8.9	3	Zewn.	★	MAE0890MB	28.3	51.6	95.6	94	1.6	9
	3	Wewn.	□	MAS0890MB	28.3	51.6	95.6	94	1.6	9
	6	Wewn.	★	MAS0890LB	55.0	78.6	122.6	121	1.6	9
9.0	3	Zewn.	★	MAE0900MB	28.6	51.6	95.6	94	1.6	9
	3	Wewn.	★	MAS0900MB	28.6	51.6	95.6	94	1.6	9
	6	Wewn.	●	MAS0900LB	55.6	78.6	122.6	121	1.6	9
9.1	3	Zewn.	★	MAE0910MB	29.0	54.7	98.7	97	1.7	10
	3	Wewn.	□	MAS0910MB	29.0	54.7	98.7	97	1.7	10
	6	Wewn.	★	MAS0910LB	56.3	82.7	126.7	125	1.7	10
9.2	3	Zewn.	★	MAE0920MB	29.3	54.7	98.7	97	1.7	10
	3	Wewn.	□	MAS0920MB	29.3	54.7	98.7	97	1.7	10
	6	Wewn.	★	MAS0920LB	56.9	82.7	126.7	125	1.7	10
9.21	3	Zewn.	★	* MAE0921MB	29.3	54.7	98.7	97	1.7	10
	3	Wewn.	★	* MAS0921MB	29.3	54.7	98.7	97	1.7	10
	6	Wewn.	★	* MAS0921LB	57.0	82.7	126.7	125	1.7	10
9.3	3	Zewn.	★	MAE0930MB	29.6	54.7	98.7	97	1.7	10
	3	Wewn.	□	MAS0930MB	29.6	54.7	98.7	97	1.7	10
	6	Wewn.	★	MAS0930LB	57.5	82.7	126.7	125	1.7	10
9.4	3	Zewn.	★	MAE0940MB	29.9	54.7	98.7	97	1.7	10
	3	Wewn.	□	MAS0940MB	29.9	54.7	98.7	97	1.7	10
	6	Wewn.	★	MAS0940LB	58.1	82.7	126.7	125	1.7	10
9.5	3	Zewn.	★	MAE0950MB	30.2	54.7	98.7	97	1.7	10
	3	Wewn.	★	MAS0950MB	30.2	54.7	98.7	97	1.7	10
	6	Wewn.	●	MAS0950LB	58.7	82.7	126.7	125	1.7	10
9.6	3	Zewn.	★	MAE0960MB	30.5	54.7	98.7	97	1.7	10
	3	Wewn.	□	MAS0960MB	30.5	54.7	98.7	97	1.7	10
	6	Wewn.	★	MAS0960LB	59.3	82.7	126.7	125	1.7	10
9.7	3	Zewn.	★	MAE0970MB	30.9	54.8	98.8	97	1.8	10
	3	Wewn.	□	MAS0970MB	30.9	54.8	98.8	97	1.8	10
	6	Wewn.	★	MAS0970LB	60.0	82.8	126.8	125	1.8	10
9.8	3	Zewn.	★	MAE0980MB	31.2	54.8	98.8	97	1.8	10
	3	Wewn.	□	MAS0980MB	31.2	54.8	98.8	97	1.8	10
	6	Wewn.	★	MAS0980LB	60.6	82.8	126.8	125	1.8	10
9.9	3	Zewn.	★	MAE0990MB	31.5	54.8	98.8	97	1.8	10
	3	Wewn.	□	MAS0990MB	31.5	54.8	98.8	97	1.8	10
	6	Wewn.	★	MAS0990LB	61.2	82.8	126.8	125	1.8	10
10.0	3	Zewn.	★	MAE1000MB	31.8	54.8	98.8	97	1.8	10
	3	Wewn.	●	MAS1000MB	31.8	54.8	98.8	97	1.8	10
	6	Wewn.	●	MAS1000LB	61.8	82.8	126.8	125	1.8	10

* : Znormalizowana średnica otworu pod gwint walcowany.

DC (mm)	Głębokość otworu (L/D)	Chłodzenie (Wewn./Zewn.)	HTI10	Numer zamówieniowy	Wymiary (mm)					
					LU	LCF	OAL	LF	PL	DCON
10.1	3	Zewn.	□	MAE1010MB	32.1	56.8	102.8	101	1.8	11
	3	Wewn.	□	MAS1010MB	32.1	56.8	102.8	101	1.8	11
	6	Wewn.	□	MAS1010LB	62.4	90.8	136.8	135	1.8	11
10.2	3	Zewn.	□	MAE1020MB	32.5	56.9	102.9	101	1.9	11
	3	Wewn.	□	MAS1020MB	32.5	56.9	102.9	101	1.9	11
	6	Wewn.	□	MAS1020LB	63.1	90.9	136.9	135	1.9	11
10.3	3	Zewn.	★	MAE1030MB	32.8	56.9	102.9	101	1.9	11
	3	Wewn.	★	MAS1030MB	32.8	56.9	102.9	101	1.9	11
	6	Wewn.	●	MAS1030LB	63.7	90.9	136.9	135	1.9	11
10.4	3	Zewn.	□	MAE1040MB	33.1	56.9	102.9	101	1.9	11
	3	Wewn.	□	MAS1040MB	33.1	56.9	102.9	101	1.9	11
	6	Wewn.	□	MAS1040LB	64.3	90.9	136.9	135	1.9	11
10.5	3	Zewn.	★	MAE1050MB	33.4	56.9	102.9	101	1.9	11
	3	Wewn.	★	MAS1050MB	33.4	56.9	102.9	101	1.9	11
	6	Wewn.	●	MAS1050LB	64.9	90.9	136.9	135	1.9	11
10.6	3	Zewn.	□	MAE1060MB	33.7	56.9	102.9	101	1.9	11
	3	Wewn.	□	MAS1060MB	33.7	56.9	102.9	101	1.9	11
	6	Wewn.	□	MAS1060LB	65.5	90.9	136.9	135	1.9	11
10.7	3	Zewn.	□	MAE1070MB	34.0	56.9	102.9	101	1.9	11
	3	Wewn.	□	MAS1070MB	34.0	56.9	102.9	101	1.9	11
	6	Wewn.	□	MAS1070LB	66.1	90.9	136.9	135	1.9	11
10.8	3	Zewn.	□	MAE1080MB	34.4	57.0	103.0	101	2.0	11
	3	Wewn.	□	MAS1080MB	34.4	57.0	103.0	101	2.0	11
	6	Wewn.	□	MAS1080LB	66.8	91.0	137.0	135	2.0	11
10.9	3	Zewn.	□	MAE1090MB	34.7	57.0	103.0	101	2.0	11
	3	Wewn.	□	MAS1090MB	34.7	57.0	103.0	101	2.0	11
	6	Wewn.	□	MAS1090LB	67.4	91.0	137.0	135	2.0	11
11.0	3	Zewn.	★	MAE1100MB	35.0	57.0	103.0	101	2.0	11
	3	Wewn.	★	MAS1100MB	35.0	57.0	103.0	101	2.0	11
	6	Wewn.	●	MAS1100LB	68.0	91.0	137.0	135	2.0	11
11.08	3	Zewn.	★	* MAE1108MB	35.2	62.0	108.0	106	2.0	12
	3	Wewn.	★	* MAS1108MB	35.2	62.0	108.0	106	2.0	12
	6	Wewn.	●	* MAS1108LB	68.5	96.0	142.0	140	2.0	12
11.1	3	Zewn.	□	MAE1110MB	35.3	62.0	108.0	106	2.0	12
	3	Wewn.	□	MAS1110MB	35.3	62.0	108.0	106	2.0	12
	6	Wewn.	□	MAS1110LB	68.6	96.0	142.0	140	2.0	12
11.2	3	Zewn.	□	MAE1120MB	35.6	62.0	108.0	106	2.0	12
	3	Wewn.	□	MAS1120MB	35.6	62.0	108.0	106	2.0	12
	6	Wewn.	□	MAS1120LB	69.2	96.0	142.0	140	2.0	12
11.3	3	Zewn.	□	MAE1130MB	36.0	62.1	108.1	106	2.1	12
	3	Wewn.	□	MAS1130MB	36.0	62.1	108.1	106	2.1	12
	6	Wewn.	□	MAS1130LB	69.9	96.1	142.1	140	2.1	12
11.4	3	Zewn.	□	MAE1140MB	36.3	62.1	108.1	106	2.1	12
	3	Wewn.	□	MAS1140MB	36.3	62.1	108.1	106	2.1	12
	6	Wewn.	□	MAS1140LB	70.5	96.1	142.1	140	2.1	12
11.5	3	Zewn.	□	MAE1150MB	36.6	62.1	108.1	106	2.1	12
	3	Wewn.	□	MAS1150MB	36.6	62.1	108.1	106	2.1	12
	6	Wewn.	□	MAS1150LB	71.1	96.1	142.1	140	2.1	12

● : Standard magazynowy. ★ : Na specjalne zamówienie z magazynu w Japonii.

□ : Niestandardowy, produkowany na specjalne zamówienie.

DC (mm)	Głębokość otworu (L/D)	Chłodzenie (Wewn./Zewn.)	HTI10	Numer zamówieniowy	Wymiary (mm)					
					LU	LCF	OAL	LF	PL	DCON
11.6	3	Zewn.	□	MAE1160MB	36.9	62.1	108.1	106	2.1	12
	3	Wewn.	□	MAS1160MB	36.9	62.1	108.1	106	2.1	12
	6	Wewn.	□	MAS1160LB	71.7	96.1	142.1	140	2.1	12
11.7	3	Zewn.	□	MAE1170MB	37.2	62.1	108.1	106	2.1	12
	3	Wewn.	□	MAS1170MB	37.2	62.1	108.1	106	2.1	12
	6	Wewn.	□	MAS1170LB	72.3	96.1	142.1	140	2.1	12
11.8	3	Zewn.	□	MAE1180MB	37.5	62.1	108.1	106	2.1	12
	3	Wewn.	□	MAS1180MB	37.5	62.1	108.1	106	2.1	12
	6	Wewn.	□	MAS1180LB	72.9	96.1	142.1	140	2.1	12
11.9	3	Zewn.	□	MAE1190MB	37.9	62.2	108.2	106	2.2	12
	3	Wewn.	□	MAS1190MB	37.9	62.2	108.2	106	2.2	12
	6	Wewn.	□	MAS1190LB	73.6	96.2	142.2	140	2.2	12
12.0	3	Zewn.	★	MAE1200MB	38.2	62.2	108.2	106	2.2	12
	3	Wewn.	●	MAS1200MB	38.2	62.2	108.2	106	2.2	12
	6	Wewn.	●	MAS1200LB	74.2	96.2	142.2	140	2.2	12
12.1	3	Zewn.	□	MAE1210MB	38.5	67.2	117.2	115	2.2	13
	3	Wewn.	□	MAS1210MB	38.5	67.2	117.2	115	2.2	13
	6	Wewn.	□	MAS1210LB	74.8	102.2	152.2	150	2.2	13
12.2	3	Zewn.	□	MAE1220MB	38.8	67.2	117.2	115	2.2	13
	3	Wewn.	□	MAS1220MB	38.8	67.2	117.2	115	2.2	13
	6	Wewn.	□	MAS1220LB	75.4	102.2	152.2	150	2.2	13
12.3	3	Zewn.	□	MAE1230MB	39.1	67.2	117.2	115	2.2	13
	3	Wewn.	□	MAS1230MB	39.1	67.2	117.2	115	2.2	13
	6	Wewn.	□	MAS1230LB	76.0	102.2	152.2	150	2.2	13
12.4	3	Zewn.	□	MAE1240MB	39.5	67.3	117.3	115	2.3	13
	3	Wewn.	□	MAS1240MB	39.5	67.3	117.3	115	2.3	13
	6	Wewn.	□	MAS1240LB	76.7	102.3	152.3	150	2.3	13
12.5	3	Zewn.	★	MAE1250MB	39.8	67.3	117.3	115	2.3	13
	3	Wewn.	●	MAS1250MB	39.8	67.3	117.3	115	2.3	13
	6	Wewn.	●	MAS1250LB	77.3	102.3	152.3	150	2.3	13
12.6	3	Zewn.	□	MAE1260MB	40.1	67.3	117.3	115	2.3	13
	3	Wewn.	□	MAS1260MB	40.1	67.3	117.3	115	2.3	13
	6	Wewn.	□	MAS1260LB	77.9	102.3	152.3	150	2.3	13
12.7	3	Zewn.	□	MAE1270MB	40.4	67.3	117.3	115	2.3	13
	3	Wewn.	□	MAS1270MB	40.4	67.3	117.3	115	2.3	13
	6	Wewn.	□	MAS1270LB	78.5	102.3	152.3	150	2.3	13
12.8	3	Zewn.	□	MAE1280MB	40.7	67.3	117.3	115	2.3	13
	3	Wewn.	□	MAS1280MB	40.7	67.3	117.3	115	2.3	13
	6	Wewn.	□	MAS1280LB	79.1	102.3	152.3	150	2.3	13
12.9	3	Zewn.	□	MAE1290MB	41.0	67.3	117.3	115	2.3	13
	3	Wewn.	□	MAS1290MB	41.0	67.3	117.3	115	2.3	13
	6	Wewn.	□	MAS1290LB	79.7	102.3	152.3	150	2.3	13
12.96	3	Zewn.	★	*MAE1296MB	41.3	67.4	117.4	115	2.4	13
	3	Wewn.	★	*MAS1296MB	41.3	67.4	117.4	115	2.4	13
	6	Wewn.	★	*MAS1296LB	80.2	102.4	152.4	150	2.4	13
13.0	3	Zewn.	★	MAE1300MB	41.4	67.4	117.4	115	2.4	13
	3	Wewn.	★	MAS1300MB	41.4	67.4	117.4	115	2.4	13
	6	Wewn.	●	MAS1300LB	80.4	102.4	152.4	150	2.4	13

* : Znormalizowana średnica otworu pod gwint walcowany.

DC (mm)	Głębokość otworu (L/D)	Chłodzenie (Wewn./Zewn.)	HTI10	Numer zamówieniowy	Wymiary (mm)					
					LU	LCF	OAL	LF	PL	DCON
13.1	3	Zewn.	□	MAE1310MB	41.7	72.4	122.4	120	2.4	14
	3	Wewn.	□	MAS1310MB	41.7	72.4	122.4	120	2.4	14
	6	Wewn.	□	MAS1310LB	81.0	112.4	162.4	160	2.4	14
13.2	3	Zewn.	□	MAE1320MB	42.0	72.4	122.4	120	2.4	14
	3	Wewn.	□	MAS1320MB	42.0	72.4	122.4	120	2.4	14
	6	Wewn.	□	MAS1320LB	81.6	112.4	162.4	160	2.4	14
13.3	3	Zewn.	□	MAE1330MB	42.3	72.4	122.4	120	2.4	14
	3	Wewn.	□	MAS1330MB	42.3	72.4	122.4	120	2.4	14
	6	Wewn.	□	MAS1330LB	82.2	112.4	162.4	160	2.4	14
13.4	3	Zewn.	□	MAE1340MB	42.6	72.4	122.4	120	2.4	14
	3	Wewn.	□	MAS1340MB	42.6	72.4	122.4	120	2.4	14
	6	Wewn.	□	MAS1340LB	82.8	112.4	162.4	160	2.4	14
13.5	3	Zewn.	★	MAE1350MB	43.0	72.5	122.5	120	2.5	14
	3	Wewn.	★	MAS1350MB	43.0	72.5	122.5	120	2.5	14
	6	Wewn.	★	MAS1350LB	83.5	112.5	162.5	160	2.5	14
13.6	3	Zewn.	□	MAE1360MB	43.3	72.5	122.5	120	2.5	14
	3	Wewn.	□	MAS1360MB	43.3	72.5	122.5	120	2.5	14
	6	Wewn.	□	MAS1360LB	84.1	112.5	162.5	160	2.5	14
13.7	3	Zewn.	□	MAE1370MB	43.6	72.5	122.5	120	2.5	14
	3	Wewn.	□	MAS1370MB	43.6	72.5	122.5	120	2.5	14
	6	Wewn.	□	MAS1370LB	84.7	112.5	162.5	160	2.5	14
13.8	3	Zewn.	□	MAE1380MB	43.9	72.5	122.5	120	2.5	14
	3	Wewn.	□	MAS1380MB	43.9	72.5	122.5	120	2.5	14
	6	Wewn.	□	MAS1380LB	85.3	112.5	162.5	160	2.5	14
13.9	3	Zewn.	□	MAE1390MB	44.2	72.5	122.5	120	2.5	14
	3	Wewn.	□	MAS1390MB	44.2	72.5	122.5	120	2.5	14
	6	Wewn.	□	MAS1390LB	85.9	112.5	162.5	160	2.5	14
14.0	3	Zewn.	★	MAE1400MB	44.5	72.5	122.5	120	2.5	14
	3	Wewn.	●	MAS1400MB	44.5	72.5	122.5	120	2.5	14
	6	Wewn.	●	MAS1400LB	86.5	112.5	162.5	160	2.5	14
14.1	3	Zewn.	□	MAE1410MB	44.9	74.6	132.6	130	2.6	15
	3	Wewn.	□	MAS1410MB	44.9	74.6	132.6	130	2.6	15
	6	Wewn.	□	MAS1410LB	87.2	117.6	175.6	173	2.6	15
14.2	3	Zewn.	□	MAE1420MB	45.2	74.6	132.6	130	2.6	15
	3	Wewn.	□	MAS1420MB	45.2	74.6	132.6	130	2.6	15
	6	Wewn.	□	MAS1420LB	87.8	117.6	175.6	173	2.6	15
14.3	3	Zewn.	□	MAE1430MB	45.5	74.6	132.6	130	2.6	15
	3	Wewn.	□	MAS1430MB	45.5	74.6	132.6	130	2.6	15
	6	Wewn.	□	MAS1430LB	88.4	117.6	175.6	173	2.6	15
14.4	3	Zewn.	□	MAE1440MB	45.8	74.6	132.6	130	2.6	15
	3	Wewn.	□	MAS1440MB	45.8	74.6	132.6	130	2.6	15
	6	Wewn.	□	MAS1440LB	89.0	117.6	175.6	173	2.6	15
14.5	3	Zewn.	□	MAE1450MB	46.1	74.6	132.6	130	2.6	15
	3	Wewn.	□	MAS1450MB	46.1	74.6	132.6	130	2.6	15
	6	Wewn.	□	MAS1450LB	89.6	117.6	175.6	173	2.6	15
14.6	3	Zewn.	□	MAE1460MB	46.5	74.7	132.7	130	2.7	15
	3	Wewn.	□	MAS1460MB	46.5	74.7	132.7	130	2.7	15
	6	Wewn.	□	MAS1460LB	90.3	117.7	175.7	173	2.7	15

MAE,MAS

M
WIERCENIE

DC (mm)	Głębokość otworu (L/D)	Chłodzenie (Wewn./Zewn.)	HT10	Numer zamówieniowy	Wymiary (mm)					
					LU	LCF	OAL	LF	PL	DCON
14.7	3	Zewn.	□	MAE1470MB	46.8	74.7	132.7	130	2.7	15
	3	Wewn.	□	MAS1470MB	46.8	74.7	132.7	130	2.7	15
	6	Wewn.	□	MAS1470LB	90.9	117.7	175.7	173	2.7	15
14.8	3	Zewn.	□	MAE1480MB	47.1	74.7	132.7	130	2.7	15
	3	Wewn.	□	MAS1480MB	47.1	74.7	132.7	130	2.7	15
	6	Wewn.	□	MAS1480LB	91.5	117.7	175.7	173	2.7	15
14.9	3	Zewn.	□	MAE1490MB	47.4	74.7	132.7	130	2.7	15
	3	Wewn.	□	MAS1490MB	47.4	74.7	132.7	130	2.7	15
	6	Wewn.	□	MAS1490LB	92.1	117.7	175.7	173	2.7	15
14.96	3	Zewn.	★	* MAE1496MB	47.6	74.7	132.7	130	2.7	15
	3	Wewn.	★	* MAS1496MB	47.6	74.7	132.7	130	2.7	15
	6	Wewn.	★	* MAS1496LB	92.5	117.7	175.7	173	2.7	15
15.0	3	Zewn.	★	MAE1500MB	47.7	74.7	132.7	130	2.7	15
	3	Wewn.	★	MAS1500MB	47.7	74.7	132.7	130	2.7	15
	6	Wewn.	●	MAS1500LB	92.7	117.7	175.7	173	2.7	15
15.1	3	Zewn.	□	MAE1510MB	48.0	78.7	136.7	134	2.7	16
	3	Wewn.	□	MAS1510MB	48.0	78.7	136.7	134	2.7	16
	6	Wewn.	□	MAS1510LB	93.3	122.7	180.7	178	2.7	16
15.2	3	Zewn.	□	MAE1520MB	48.4	78.8	136.8	134	2.8	16
	3	Wewn.	□	MAS1520MB	48.4	78.8	136.8	134	2.8	16
	6	Wewn.	□	MAS1520LB	94.0	122.8	180.8	178	2.8	16
15.3	3	Zewn.	□	MAE1530MB	48.7	78.8	136.8	134	2.8	16
	3	Wewn.	□	MAS1530MB	48.7	78.8	136.8	134	2.8	16
	6	Wewn.	□	MAS1530LB	94.6	122.8	180.8	178	2.8	16
15.4	3	Zewn.	□	MAE1540MB	49.0	78.8	136.8	134	2.8	16
	3	Wewn.	□	MAS1540MB	49.0	78.8	136.8	134	2.8	16
	6	Wewn.	□	MAS1540LB	95.2	122.8	180.8	178	2.8	16
15.5	3	Zewn.	□	MAE1550MB	49.3	78.8	136.8	134	2.8	16
	3	Wewn.	□	MAS1550MB	49.3	78.8	136.8	134	2.8	16
	6	Wewn.	□	MAS1550LB	95.8	122.8	180.8	178	2.8	16
15.6	3	Zewn.	□	MAE1560MB	49.6	78.8	136.8	134	2.8	16
	3	Wewn.	□	MAS1560MB	49.6	78.8	136.8	134	2.8	16
	6	Wewn.	□	MAS1560LB	96.4	122.8	180.8	178	2.8	16
15.7	3	Zewn.	□	MAE1570MB	50.0	78.9	136.9	134	2.9	16
	3	Wewn.	□	MAS1570MB	50.0	78.9	136.9	134	2.9	16
	6	Wewn.	□	MAS1570LB	97.1	122.9	180.9	178	2.9	16
15.8	3	Zewn.	□	MAE1580MB	50.3	78.9	136.9	134	2.9	16
	3	Wewn.	□	MAS1580MB	50.3	78.9	136.9	134	2.9	16
	6	Wewn.	□	MAS1580LB	97.7	122.9	180.9	178	2.9	16
15.9	3	Zewn.	□	MAE1590MB	50.6	78.9	136.9	134	2.9	16
	3	Wewn.	□	MAS1590MB	50.6	78.9	136.9	134	2.9	16
	6	Wewn.	□	MAS1590LB	98.3	122.9	180.9	178	2.9	16
16.0	3	Zewn.	★	MAE1600MB	50.9	78.9	136.9	134	2.9	16
	3	Wewn.	★	MAS1600MB	50.9	78.9	136.9	134	2.9	16
	6	Wewn.	●	MAS1600LB	98.9	122.9	180.9	178	2.9	16

* : Znormalizowana średnica otworu pod gwint walcowany.

● : Standard magazynowy. ★ : Na specjalne zamówienie z magazynu w Japonii.

□ : Niestandardowy, produkowany na specjalne zamówienie.

ZALECANE PARAMETRY SKRAWANIA

Typ	Materiał przedmiotu obrabianego	Średnica wiertła $\phi 3.0 - \phi 6.0$		Średnica wiertła $\phi 6.1 - \phi 10.0$		Średnica wiertła $\phi 10.1 - \phi 16.0$	
		Prędkość skrawania (m/min)	Posuw (mm/obr.)	Prędkość skrawania (m/min)	Posuw (mm/obr.)	Prędkość skrawania (m/min)	Posuw (mm/obr.)
MAE	N Stopy aluminium	90 (40–140)	0.15 (0.05–0.3)	100 (50–150)	0.2 (0.1–0.3)	120 (60–170)	0.25 (0.1–0.4)
	Odlewy ze stopu aluminium	100 (60–150)	0.12 (0.05–0.25)	110 (70–160)	0.15 (0.05–0.25)	130 (80–180)	0.2 (0.1–0.3)
	K Żeliwo szare	40 (20–60)	0.15 (0.1–0.2)	60 (40–80)	0.2 (0.1–0.3)	80 (60–100)	0.3 (0.2–0.4)
	Żeliwo sferoidalne (GGG)	30 (20–40)	0.1 (0.05–0.15)	40 (20–60)	0.12 (0.05–0.2)	60 (40–80)	0.2 (0.1–0.3)
MAS	N Stopy aluminium	100 (60–150)	0.15 (0.05–0.3)	120 (80–170)	0.2 (0.1–0.3)	150 (100–200)	0.25 (0.1–0.4)
	Odlewy ze stopu aluminium	120 (80–170)	0.12 (0.05–0.25)	150 (100–180)	0.15 (0.05–0.25)	160 (120–200)	0.2 (0.1–0.3)
	K Żeliwo szare	60 (40–80)	0.15 (0.1–0.2)	80 (60–110)	0.2 (0.1–0.3)	100 (70–130)	0.3 (0.2–0.4)
	Żeliwo sferoidalne (GGG)	45 (30–60)	0.1 (0.05–0.15)	60 (40–80)	0.12 (0.05–0.2)	80 (60–100)	0.2 (0.1–0.3)

■ ŚREDNICE OTWORÓW I WIERTEŁ POD GWINT

Wielkość gwintu	Gwinty nacinane			Gwinty walcowane		
	Średnica wiertła (DC)	Średnica otworu		Średnica wiertła (DC)	Średnica otworu	
		min.	maks.		min.	maks.
M4x0.7	3.3	3.242	3.422	3.65	3.65	3.70
M5x0.8	4.2	4.134	4.334	4.60	4.59	4.66
M6x1.0	5.0	4.917	5.153	5.50	5.48	5.57
M8x1.25	6.8	6.647	6.912	7.35	7.34	7.41
M10x1.5	8.5	8.376	8.676	9.21	9.18	9.28
M12x1.75	10.3	10.106	10.441	11.08	11.05	11.15
M14x2	12.0	11.835	12.210	12.96	12.92	13.04
M16x2	14.0	13.835	14.210	14.96	14.92	15.04

WIERCENIE (WIERTŁA PEŁNOWĘGLIKOWE)

MHS

- Wysoka wytrzymałość na wyboeczenie i unikalna podwójna łysinka.
- Wiercenie w stalach o wysokiej twardości (35-55 HRC) bez wycofania wiertła, wysoka trwałość wiertła.



WĘGLIKI SPIEKANE



Chłodzenie wewnętrzne



M

WIERCENIE

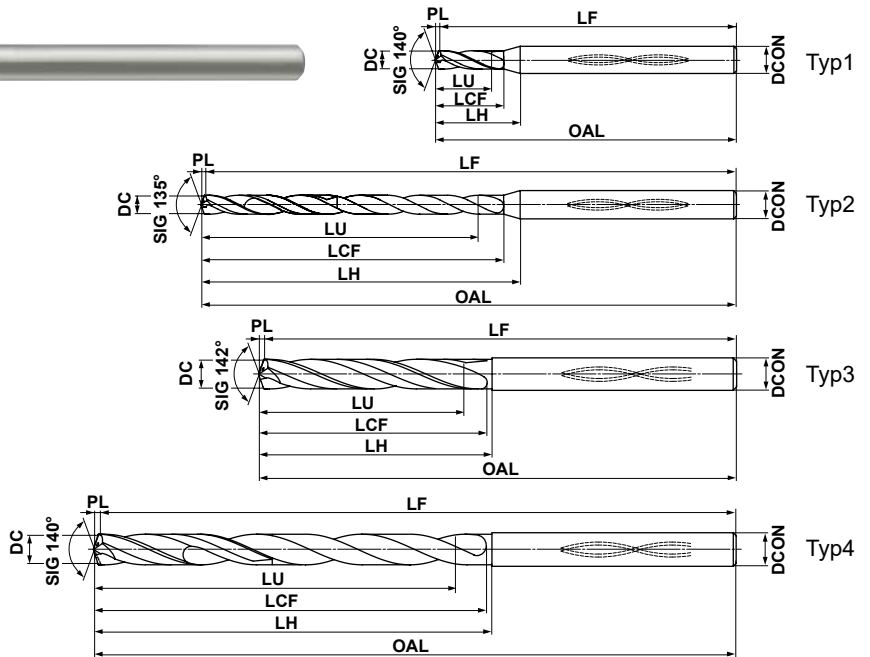

	DC ≤ 3	3 < DC ≤ 6	6 < DC ≤ 10	10 < DC ≤ 12
	+0.010 -0.002	+0.010 -0.002	+0.010 -0.005	+0.010 -0.008
	DCON=3	3 < DCON ≤ 6	6 < DCON ≤ 10	10 < DCON ≤ 12
	0 -0.006	0 -0.008	0 -0.009	0 -0.011

- Wiertła MHS można stosować z oprawkami termokurczliwymi.
- Jako wiertła pilotowego użyć najkrótszego wiertła o odpowiedniej średnicy.

DC (mm)	Głębokość otworu (L/D)	VP15TF	Numer zamówieniowy	Wymiary (mm)							Typ
				LU	LCF	LH	OAL	LF	PL	DCON	
0.95	3	★	MHS0095L006B	3.0	6.2	10.0	60.2	60	0.17	3	1
	6	★	MHS0095L009B	5.9	9.2	13.0	60.2	60	0.17	3	2
	13	★	MHS0095L015B	12.5	15.2	19.0	60.2	60	0.17	3	2
	23	★	MHS0095L025B	22.0	25.2	29.0	60.2	60	0.17	3	2
	30	★	MHS0095L035B	28.7	35.2	39.0	80.2	80	0.17	3	2
1.00	3	●	MHS0100L006B	3.2	6.2	9.9	60.2	60	0.2	3	1
	6	●	MHS0100L009B	6.2	9.2	12.9	60.2	60	0.2	3	2
	12	★	MHS0100L015B	12.2	15.2	18.9	60.2	60	0.2	3	2
	22	●	MHS0100L025B	22.2	25.2	28.9	60.2	60	0.2	3	2
	30	●	MHS0100L035B	30.2	35.2	38.9	80.2	80	0.2	3	2
1.10	2	●	MHS0110L006B	2.4	6.2	9.7	60.2	60	0.2	3	1
	5	★	MHS0110L009B	5.7	9.2	12.7	60.2	60	0.2	3	2
	11	●	MHS0110L015B	12.3	15.2	18.7	60.2	60	0.2	3	2
	20	●	MHS0110L025B	22.2	25.2	28.7	60.2	60	0.2	3	2
	29	●	MHS0110L035B	32.1	35.2	38.7	80.2	80	0.2	3	2
1.20	2	●	MHS0120L006B	2.6	6.2	9.6	60.2	60	0.2	3	1
	5	★	MHS0120L009B	6.2	9.2	12.6	60.2	60	0.2	3	2
	10	●	MHS0120L015B	12.2	15.2	18.6	60.2	60	0.2	3	2
	18	●	MHS0120L025B	21.8	25.2	28.6	60.2	60	0.2	3	2
	26	●	MHS0120L035B	31.4	35.2	38.6	80.2	80	0.2	3	2
1.30	2	●	MHS0130L007B	2.8	7.2	10.4	60.2	60	0.2	3	1
	5	★	MHS0130L011B	6.8	11.3	14.5	60.3	60	0.3	3	2
	12	●	MHS0130L020B	15.9	20.3	23.5	60.3	60	0.3	3	2
	20	●	MHS0130L030B	26.3	30.3	33.5	80.3	80	0.3	3	2
	30	●	MHS0130L045B	39.3	45.3	48.5	80.3	80	0.3	3	2

DC (mm)	Głębokość otworu (L/D)	VP15TF	Numer zamówieniowy	Wymiary (mm)							Typ
				LU	LCF	LH	OAL	LF	PL	DCON	
1.40	2	●	MHS0140L007B	3.1	7.3	10.3	60.3	60	0.3	3	1
	5	★	MHS0140L011B	7.3	11.3	14.3	60.3	60	0.3	3	2
	11	●	MHS0140L020B	15.7	20.3	23.3	60.3	60	0.3	3	2
	18	★	MHS0140L030B	25.5	30.3	33.3	80.3	80	0.3	3	2
	29	★	MHS0140L045B	40.9	45.3	48.3	80.3	80	0.3	3	2
1.45	3	●	MHS0145L008B	4.7	8.3	11.2	60.3	60	0.3	3	1
	6	★	MHS0145L013B	9.0	13.3	16.2	60.3	60	0.3	3	2
	11	★	MHS0145L020B	16.3	20.3	23.2	60.3	60	0.3	3	2
	21	●	MHS0145L035B	30.8	35.3	38.2	80.3	80	0.3	3	2
	30	★	MHS0145L055B	43.8	55.3	58.2	100.3	100	0.3	3	2
1.50	2	●	MHS0150L008B	3.3	8.3	11.1	60.3	60	0.3	3	1
	6	★	MHS0150L013B	9.3	13.3	16.1	60.3	60	0.3	3	2
	10	●	MHS0150L020B	15.3	20.3	23.1	60.3	60	0.3	3	2
	20	●	MHS0150L035B	30.3	35.3	38.1	80.3	80	0.3	3	2
	30	●	MHS0150L055B	45.3	55.3	58.1	100.3	100	0.3	3	2
1.60	2	●	MHS0160L008B	3.5	8.3	10.9	60.3	60	0.3	3	1
	5	★	MHS0160L013B	8.3	13.3	15.9	60.3	60	0.3	3	2
	10	●	MHS0160L020B	16.3	20.3	22.9	60.3	60	0.3	3	2
	19	●	MHS0160L035B	30.7	35.3	37.9	80.3	80	0.3	3	2
	30	●	MHS0160L055B	48.3	55.3	57.9	100.3	100	0.3	3	2
1.70	2	●	MHS0170L008B	3.7	8.3	10.7	60.3	60	0.3	3	1
	5	★	MHS0170L013B	8.9	13.4	15.8	60.4	60	0.4	3	2
	9	●	MHS0170L020B	15.7	20.4	22.8	60.4	60	0.4	3	2
	18	●	MHS0170L035B	31.0	35.4	37.8	80.4	80	0.4	3	2
	29	●	MHS0170L055B	49.7	55.4	57.8	100.4	100	0.4	3	2

Uwaga 1) Gdy geometria wiertła nie odpowiada wartościom podanym w tabeli (np. inna średnica i długość wiertła), prosimy o skontaktowanie się z naszą firmą.

● : Standard magazynowy. ★ : Na specjalne zamówienie z magazynu w Japonii.

□ : Niestandardowy, produkowany na specjalne zamówienie.

DC (mm)	Głębokość otworu (L/D)	VP15TF	Numer zamówieniowy	Wymiary (mm)								Typ
				LU	LCF	LH	OAL	LF	PL	DCON		
1.80	3	●	MHS0180L010B	5.7	10.3	12.5	60.3	60	0.3	3	1	
	5	★	MHS0180L015B	9.4	15.4	17.6	60.4	60	0.4	3	2	
	11	●	MHS0180L025B	20.2	25.4	27.6	60.4	60	0.4	3	2	
	22	●	MHS0180L045B	40.0	45.4	47.6	80.4	80	0.4	3	2	
	30	●	MHS0180L065B	54.4	65.4	67.6	100.4	100	0.4	3	2	
1.90	2	●	MHS0190L010B	4.1	10.3	12.4	60.3	60	0.3	3	1	
	5	★	MHS0190L015B	9.9	15.4	17.5	60.4	60	0.4	3	2	
	10	●	MHS0190L025B	19.4	25.4	27.5	60.4	60	0.4	3	2	
	21	●	MHS0190L045B	40.3	45.4	47.5	80.4	80	0.4	3	2	
	30	●	MHS0190L065B	57.4	65.4	67.5	100.4	100	0.4	3	2	
1.95	2	●	MHS0195L010B	4.3	10.4	12.4	60.4	60	0.4	3	1	
	5	★	MHS0195L015B	10.2	15.4	17.4	60.4	60	0.4	3	2	
	10	★	MHS0195L025B	19.9	25.4	27.4	60.4	60	0.4	3	2	
	20	●	MHS0195L045B	39.4	45.4	47.4	80.4	80	0.4	3	2	
	30	★	MHS0195L065B	58.9	65.4	67.4	100.4	100	0.4	3	2	
2.00	2	●	MHS0200L010B	4.4	10.4	12.3	60.4	60	0.4	3	1	
	5	★	MHS0200L015B	10.4	15.4	17.3	60.4	60	0.4	3	2	
	9	●	MHS0200L025B	18.4	25.4	27.3	60.4	60	0.4	3	2	
	20	●	MHS0200L045B	40.4	45.4	47.3	80.4	80	0.4	3	2	
	30	●	MHS0200L065B	60.4	65.4	67.3	100.4	100	0.4	3	2	
2.10	3	●	MHS0210L012B	6.7	12.4	14.1	60.4	60	0.4	3	1	
	7	★	MHS0210L020B	15.1	20.4	22.1	60.4	60	0.4	3	2	
	11	●	MHS0210L030B	23.5	30.4	32.1	80.4	80	0.4	3	2	
	23	●	MHS0210L055B	48.7	55.4	57.1	100.4	100	0.4	3	2	
	30	●	MHS0210L075B	63.4	75.4	77.1	120.4	120	0.4	3	2	
2.20	2	●	MHS0220L012B	4.8	12.4	13.9	60.4	60	0.4	3	1	
	6	★	MHS0220L020B	13.7	20.5	22.0	60.5	60	0.5	3	2	
	11	●	MHS0220L030B	24.7	30.5	32.0	80.5	80	0.5	3	2	
	22	●	MHS0220L055B	48.9	55.5	57.0	100.5	100	0.5	3	2	
	30	●	MHS0220L075B	66.5	75.5	77.0	120.5	120	0.5	3	2	
2.30	2	●	MHS0230L012B	5.0	12.4	13.7	60.4	60	0.4	3	1	
	6	★	MHS0230L020B	14.3	20.5	21.8	60.5	60	0.5	3	2	
	10	●	MHS0230L030B	23.5	30.5	31.8	80.5	80	0.5	3	2	
	21	●	MHS0230L055B	48.8	55.5	56.8	100.5	100	0.5	3	2	
	30	●	MHS0230L075B	69.5	75.5	76.8	120.5	120	0.5	3	2	
2.40	2	●	MHS0240L012B	5.2	12.4	13.5	60.4	60	0.4	3	1	
	5	★	MHS0240L020B	12.5	20.5	21.6	60.5	60	0.5	3	2	
	9	●	MHS0240L030B	22.1	30.5	31.6	80.5	80	0.5	3	2	
	20	●	MHS0240L055B	48.5	55.5	56.6	100.5	100	0.5	3	2	
	28	●	MHS0240L075B	67.7	75.5	76.6	120.5	120	0.5	3	2	
2.45	2	★	MHS0245L013B	5.3	13.4	14.4	70.4	70	0.4	4	1	
	5	★	MHS0245L020B	12.8	20.5	21.5	70.5	70	0.5	4	2	
	11	★	MHS0245L035B	27.5	35.5	36.5	90.5	90	0.5	4	2	
	24	★	MHS0245L065B	59.3	65.5	66.5	110.5	110	0.5	4	2	
	30	★	MHS0245L090B	74.0	90.5	91.5	140.5	140	0.5	4	2	
2.50	2	●	MHS0250L013B	5.5	13.5	16.3	70.5	70	0.5	4	1	
	5	★	MHS0250L020B	13.0	20.5	23.3	70.5	70	0.5	4	2	
	11	●	MHS0250L035B	28.0	35.5	38.3	90.5	90	0.5	4	2	
	23	●	MHS0250L065B	58.0	65.5	68.3	110.5	110	0.5	4	2	
	30	●	MHS0250L090B	75.5	90.5	93.3	140.5	140	0.5	4	2	

DC (mm)	Głębokość otworu (L/D)	VP15TF	Numer zamówieniowy	Wymiary (mm)								Typ
				LU	LCF	LH	OAL	LF	PL	DCON		
2.60	2	●	MHS0260L013B	5.7	13.5	16.1	70.5	70	0.5	4	1	
	5	★	MHS0260L020B	13.5	20.5	23.1	70.5	70	0.5	4	2	
	10	●	MHS0260L035B	26.5	35.5	38.1	90.5	90	0.5	4	2	
	22	●	MHS0260L065B	57.7	65.5	68.1	110.5	110	0.5	4	2	
	30	●	MHS0260L090B	78.5	90.5	93.1	140.5	140	0.5	4	2	
2.70	2	●	MHS0270L013B	5.9	13.5	15.9	70.5	70	0.5	4	1	
	4	★	MHS0270L020B	11.4	20.6	23.0	70.6	70	0.6	4	2	
	10	●	MHS0270L035B	27.6	35.6	38.0	90.6	90	0.6	4	2	
	21	●	MHS0270L065B	57.3	65.6	68.0	110.6	110	0.6	4	2	
	30	●	MHS0270L090B	81.6	90.6	93.0	140.6	140	0.6	4	2	
2.80	2	●	MHS0280L014B	6.1	14.5	16.7	70.5	70	0.5	4	1	
	4	★	MHS0280L020B	11.8	20.6	22.8	70.6	70	0.6	4	2	
	9	●	MHS0280L035B	25.8	35.6	37.8	90.6	90	0.6	4	2	
	20	●	MHS0280L065B	56.6	65.6	67.8	110.6	110	0.6	4	2	
	29	●	MHS0280L090B	81.8	90.6	92.8	140.6	140	0.6	4	2	
2.90	2	●	MHS0290L014B	6.3	14.5	16.6	70.5	70	0.5	4	1	
	4	★	MHS0290L020B	12.2	20.6	22.7	70.6	70	0.6	4	2	
	9	●	MHS0290L035B	26.7	35.6	37.7	90.6	90	0.6	4	2	
	19	●	MHS0290L065B	55.7	65.6	67.7	110.6	110	0.6	4	2	
	28	●	MHS0290L090B	81.8	90.6	92.7	140.6	140	0.6	4	2	
2.95	2	★	MHS0295L014B	6.4	14.5	16.5	70.5	70	0.5	4	1	
	4	★	MHS0295L020B	12.4	20.6	22.6	70.6	70	0.6	4	2	
	9	★	MHS0295L035B	27.2	35.6	37.6	90.6	90	0.6	4	2	
	19	●	MHS0295L065B	56.7	65.6	67.6	110.6	110	0.6	4	2	
	28	★	MHS0295L090B	83.2	90.6	92.6	140.6	140	0.6	4	2	
3.0	4	●	MHS0300L020B	12.5	19.5	20.5	70.5	70	0.5	4	3	
	10	●	MHS0300L040B	30.5	39.5	40.5	90.5	90	0.5	4	4	
	17	●	MHS0300L060B	51.5	59.5	60.5	110.5	110	0.5	4	4	
	27	●	MHS0300L090B	81.5	89.5	90.5	140.5	140	0.5	4	4	
	3.1	4	□	MHS0310L020B	12.9	20.0	20.5	70.5	70	0.5	4	3
10		□	MHS0310L040B	31.6	40.1	40.6	90.6	90	0.6	4	4	
17		□	MHS0310L060B	53.3	60.1	60.6	110.6	110	0.6	4	4	
26		□	MHS0310L090B	81.2	90.1	90.6	140.6	140	0.6	4	4	
3.2		4	□	MHS0320L020B	13.4	20.1	20.6	70.6	70	0.6	4	3
	10	□	MHS0320L040B	32.6	40.1	40.6	90.6	90	0.6	4	4	
	16	□	MHS0320L060B	51.8	60.1	60.6	110.6	110	0.6	4	4	
	25	□	MHS0320L090B	80.6	90.1	90.6	140.6	140	0.6	4	4	
	3.3	3	□	MHS0330L020B	10.5	20.1	20.6	70.6	70	0.6	4	3
9		□	MHS0330L040B	30.3	40.1	40.6	90.6	90	0.6	4	4	
16		□	MHS0330L060B	53.4	60.1	60.6	110.6	110	0.6	4	4	
25		□	MHS0330L090B	83.1	90.1	90.6	140.6	140	0.6	4	4	
3.4		3	□	MHS0340L020B	10.8	20.1	20.6	70.6	70	0.6	4	3
	9	□	MHS0340L040B	31.2	40.1	40.6	90.6	90	0.6	4	4	
	15	□	MHS0340L060B	51.6	60.1	60.6	110.6	110	0.6	4	4	
	24	□	MHS0340L090B	82.2	90.1	90.6	140.6	140	0.6	4	4	
	3.5	3	●	MHS0350L020B	11.1	20.1	20.6	70.6	70	0.6	4	3
9		●	MHS0350L040B	32.1	40.1	40.6	90.6	90	0.6	4	4	
14		●	MHS0350L060B	49.6	60.1	60.6	110.6	110	0.6	4	4	
23		●	MHS0350L090B	81.1	90.1	90.6	140.6	140	0.6	4	4	

WIERCENIE (WIERTŁA PEŁNOWĘGLIKOWE)

MHS

WĘGLIKI
SPIEKANE

M

WIERCENIE

DC (mm)	Głębokość otworu (L/D)	VP15TF	Numer zamówieniowy	Wymiary (mm)							Typ
				LU	LCF	LH	OAL	LF	PL	DCON	
3.6	3	□	MHS0360L020B	11.4	20.6	20.6	70.6	70	0.6	4	3
	9	□	MHS0360L040B	33.1	40.7	40.7	90.7	90	0.7	4	4
	14	□	MHS0360L060B	51.1	60.7	60.7	110.7	110	0.7	4	4
	22	□	MHS0360L090B	79.9	90.7	90.7	140.7	140	0.7	4	4
	30	□	MHS0360L120B	108.7	120.7	120.7	170.7	170	0.7	4	4
3.7	3	□	MHS0370L020B	11.7	20.6	20.6	70.6	70	0.6	4	3
	8	□	MHS0370L040B	30.3	40.7	40.7	90.7	90	0.7	4	4
	14	□	MHS0370L060B	52.5	60.7	60.7	110.7	110	0.7	4	4
	22	□	MHS0370L090B	82.1	90.7	90.7	140.7	140	0.7	4	4
3.8	3	★	MHS0380L020B	12.1	20.7	20.7	70.7	70	0.7	4	3
	8	★	MHS0380L040B	31.1	40.7	40.7	90.7	90	0.7	4	4
	13	★	MHS0380L060B	50.1	60.7	60.7	110.7	110	0.7	4	4
	21	★	MHS0380L090B	80.5	90.7	90.7	140.7	140	0.7	4	4
	29	★	MHS0380L120B	110.9	120.7	120.7	170.7	170	0.7	4	4
3.9	3	★	MHS0390L020B	12.4	20.7	20.7	70.7	70	0.7	4	3
	8	★	MHS0390L040B	31.9	40.7	40.7	90.7	90	0.7	4	4
	13	★	MHS0390L060B	51.4	60.7	60.7	110.7	110	0.7	4	4
	21	□	MHS0390L090B	82.6	90.7	90.7	140.7	140	0.7	4	4
	28	□	MHS0390L120B	109.9	120.7	120.7	170.7	170	0.7	4	4
4.0	2	●	MHS0400L020B	8.7	20.7	20.7	70.7	70	0.7	4	3
	7	●	MHS0400L040B	28.7	40.7	40.7	90.7	90	0.7	4	4
	12	●	MHS0400L060B	48.7	60.7	60.7	110.7	110	0.7	4	4
	20	●	MHS0400L090B	80.7	90.7	90.7	140.7	140	0.7	4	4
	27	●	MHS0400L120B	108.7	120.7	120.7	170.7	170	0.7	4	4
4.1	2	□	MHS0410L020B	8.9	19.2	20.7	70.7	70	0.7	6	3
	7	□	MHS0410L040B	29.4	39.2	40.7	90.7	90	0.7	6	4
	12	□	MHS0410L060B	49.9	59.2	60.7	110.7	110	0.7	6	4
	19	□	MHS0410L090B	78.6	89.2	90.7	140.7	140	0.7	6	4
	26	□	MHS0410L120B	107.3	119.2	120.7	170.7	170	0.7	6	4
4.2	2	□	MHS0420L020B	9.1	19.2	20.7	70.7	70	0.7	6	3
	7	□	MHS0420L040B	30.2	39.3	40.8	90.8	90	0.8	6	4
	11	□	MHS0420L060B	47.0	59.3	60.8	110.8	110	0.8	6	4
	19	□	MHS0420L090B	80.6	89.3	90.8	140.8	140	0.8	6	4
	26	□	MHS0420L120B	110.0	119.3	120.8	170.8	170	0.8	6	4
4.3	2	□	MHS0430L020B	9.3	19.2	20.7	70.7	70	0.7	6	3
	6	□	MHS0430L040B	26.6	39.3	40.8	90.8	90	0.8	6	4
	11	□	MHS0430L060B	48.1	59.3	60.8	110.8	110	0.8	6	4
	18	□	MHS0430L090B	78.2	89.3	90.8	140.8	140	0.8	6	4
	25	□	MHS0430L120B	108.3	119.3	120.8	170.8	170	0.8	6	4
4.4	2	★	MHS0440L020B	9.6	19.3	20.8	70.8	70	0.8	6	3
	6	□	MHS0440L040B	27.2	39.3	40.8	90.8	90	0.8	6	4
	11	□	MHS0440L060B	49.2	59.3	60.8	110.8	110	0.8	6	4
	18	□	MHS0440L090B	80.0	89.3	90.8	140.8	140	0.8	6	4
	24	□	MHS0440L120B	106.4	119.3	120.8	170.8	170	0.8	6	4
4.5	2	●	MHS0450L020B	9.8	19.3	20.8	70.8	70	0.8	6	3
	6	●	MHS0450L040B	27.8	39.3	40.8	90.8	90	0.8	6	4
	10	●	MHS0450L060B	45.8	59.3	60.8	110.8	110	0.8	6	4
	17	●	MHS0450L090B	77.3	89.3	90.8	140.8	140	0.8	6	4
	24	●	MHS0450L120B	108.8	119.3	120.8	170.8	170	0.8	6	4

DC (mm)	Głębokość otworu (L/D)	VP15TF	Numer zamówieniowy	Wymiary (mm)							Typ
				LU	LCF	LH	OAL	LF	PL	DCON	
4.6	2	□	MHS0460L020B	10.0	19.8	20.8	70.8	70	0.8	6	3
	6	□	MHS0460L040B	28.4	39.8	40.8	90.8	90	0.8	6	4
	10	□	MHS0460L060B	46.8	59.8	60.8	110.8	110	0.8	6	4
	17	□	MHS0460L090B	79.0	89.8	90.8	140.8	140	0.8	6	4
	23	□	MHS0460L120B	106.6	119.8	120.8	170.8	170	0.8	6	4
	30	□	MHS0460L150B	138.8	149.8	150.8	200.8	200	0.8	6	4
4.7	2	□	MHS0470L020B	10.2	19.8	20.8	70.8	70	0.8	6	3
	6	□	MHS0470L040B	29.1	39.9	40.9	90.9	90	0.9	6	4
	10	□	MHS0470L060B	47.9	59.9	60.9	110.9	110	0.9	6	4
	16	□	MHS0470L090B	76.1	89.9	90.9	140.9	140	0.9	6	4
	23	□	MHS0470L120B	109.0	119.9	120.9	170.9	170	0.9	6	4
	29	□	MHS0470L150B	137.2	149.9	150.9	200.9	200	0.9	6	4
4.8	1	★	MHS0480L020B	5.6	19.8	20.8	70.8	70	0.8	6	3
	6	★	MHS0480L040B	29.7	39.9	40.9	90.9	90	0.9	6	4
	10	★	MHS0480L060B	48.9	59.9	60.9	110.9	110	0.9	6	4
	16	★	MHS0480L090B	77.7	89.9	90.9	140.9	140	0.9	6	4
	22	★	MHS0480L120B	106.5	119.9	120.9	170.9	170	0.9	6	4
29	★	MHS0480L150B	140.1	149.9	150.9	200.9	200	0.9	6	4	
4.9	1	□	MHS0490L020B	5.7	19.8	20.8	70.8	70	0.8	6	3
	5	□	MHS0490L040B	25.4	39.9	40.9	90.9	90	0.9	6	4
	10	□	MHS0490L060B	49.9	59.9	60.9	110.9	110	0.9	6	4
	16	□	MHS0490L090B	79.3	89.9	90.9	140.9	140	0.9	6	4
	22	□	MHS0490L120B	108.7	119.9	120.9	170.9	170	0.9	6	4
	28	□	MHS0490L150B	138.1	149.9	150.9	200.9	200	0.9	6	4
5.0	1	●	MHS0500L020B	5.9	19.9	20.9	70.9	70	0.9	6	3
	5	●	MHS0500L040B	25.9	39.9	40.9	90.9	90	0.9	6	4
	9	●	MHS0500L060B	45.9	59.9	60.9	110.9	110	0.9	6	4
	15	●	MHS0500L090B	75.9	89.9	90.9	140.9	140	0.9	6	4
	21	●	MHS0500L120B	105.9	119.9	120.9	170.9	170	0.9	6	4
	27	●	MHS0500L150B	135.9	149.9	150.9	200.9	200	0.9	6	4
5.1	3	□	MHS0510L030B	16.2	30.4	30.9	80.9	80	0.9	6	3
	9	□	MHS0510L060B	46.8	60.4	60.9	110.9	110	0.9	6	4
	15	□	MHS0510L090B	77.4	90.4	90.9	140.9	140	0.9	6	4
	21	□	MHS0510L120B	108.0	120.4	120.9	170.9	170	0.9	6	4
	27	□	MHS0510L150B	138.6	150.4	150.9	200.9	200	0.9	6	4
5.2	3	□	MHS0520L030B	16.5	30.4	30.9	80.9	80	0.9	6	3
	9	□	MHS0520L060B	47.7	60.4	60.9	110.9	110	0.9	6	4
	15	□	MHS0520L090B	78.9	90.4	90.9	140.9	140	0.9	6	4
	20	□	MHS0520L120B	104.9	120.4	120.9	170.9	170	0.9	6	4
	26	□	MHS0520L150B	136.1	150.4	150.9	200.9	200	0.9	6	4
5.3	3	□	MHS0530L030B	16.8	30.4	30.9	80.9	80	0.9	6	3
	9	□	MHS0530L060B	48.7	60.5	61.0	111.0	110	1.0	6	4
	14	★	MHS0530L090B	75.2	90.5	91.0	141.0	140	1.0	6	4
	20	□	MHS0530L120B	107.0	120.5	121.0	171.0	170	1.0	6	4
	26	□	MHS0530L150B	138.8	150.5	151.0	201.0	200	1.0	6	4
5.4	3	□	MHS0540L030B	17.1	30.4	30.9	80.9	80	0.9	6	3
	9	□	MHS0540L060B	49.6	60.5	61.0	111.0	110	1.0	6	4
	14	□	MHS0540L090B	76.6	90.5	91.0	141.0	140	1.0	6	4
	20	□	MHS0540L120B	109.0	120.5	121.0	171.0	170	1.0	6	4
	25	□	MHS0540L150B	136.0	150.5	151.0	201.0	200	1.0	6	4

Uwaga 1) Gdy geometria wiertła nie odpowiada wartościom podanym w tabeli (np. inna średnica i długość wiertła), prosimy o skontaktowanie się z naszą firmą.

● : Standard magazynowy. ★ : Na specjalne zamówienie z magazynu w Japonii.

□ : Niestandardowy, produkowany na specjalne zamówienie.

DC (mm)	Głębokość otworu (L/D)	VP15TF	Numer zamówieniowy	Wymiary (mm)							Typ
				LU	LCF	LH	OAL	LF	PL	DCON	
5.5	3	●	MHS0550L030B	17.4	30.4	30.9	80.9	80	0.9	6	3
	8	●	MHS0550L060B	45.0	60.5	61.0	111.0	110	1.0	6	4
	14	●	MHS0550L090B	78.0	90.5	91.0	141.0	140	1.0	6	4
	19	●	MHS0550L120B	105.5	120.5	121.0	171.0	170	1.0	6	4
	25	●	MHS0550L150B	138.5	150.5	151.0	201.0	200	1.0	6	4
5.6	3	□	MHS0560L030B	17.8	31.0	31.0	81.0	80	1.0	6	3
	8	□	MHS0560L060B	45.8	61.0	61.0	111.0	110	1.0	6	4
	14	□	MHS0560L090B	79.4	91.0	91.0	141.0	140	1.0	6	4
	19	□	MHS0560L120B	107.4	121.0	121.0	171.0	170	1.0	6	4
	24	□	MHS0560L150B	135.4	151.0	151.0	201.0	200	1.0	6	4
5.7	3	□	MHS0570L030B	18.1	31.0	31.0	81.0	80	1.0	6	3
	8	□	MHS0570L060B	46.6	61.0	61.0	111.0	110	1.0	6	4
	13	□	MHS0570L090B	75.1	91.0	91.0	141.0	140	1.0	6	4
	19	□	MHS0570L120B	109.3	121.0	121.0	171.0	170	1.0	6	4
	24	□	MHS0570L150B	137.8	151.0	151.0	201.0	200	1.0	6	4
5.8	3	★	MHS0580L030B	18.4	31.0	31.0	81.0	80	1.0	6	3
	8	★	MHS0580L060B	47.5	61.1	61.1	111.1	110	1.1	6	4
	13	★	MHS0580L090B	76.5	91.1	91.1	141.1	140	1.1	6	4
	18	★	MHS0580L120B	105.5	121.1	121.1	171.1	170	1.1	6	4
	23	★	MHS0580L150B	134.5	151.1	151.1	201.1	200	1.1	6	4
5.9	3	□	MHS0590L030B	18.7	31.0	31.0	81.0	80	1.0	6	3
	8	□	MHS0590L060B	48.3	61.1	61.1	111.1	110	1.1	6	4
	13	□	MHS0590L090B	77.8	91.1	91.1	141.1	140	1.1	6	4
	18	□	MHS0590L120B	107.3	121.1	121.1	171.1	170	1.1	6	4
	23	□	MHS0590L150B	136.8	151.1	151.1	201.1	200	1.1	6	4
6.0	2	●	MHS0600L030B	13.0	31.0	31.0	81.0	80	1.0	6	3
	7	●	MHS0600L060B	43.1	61.1	61.1	111.1	110	1.1	6	4
	12	●	MHS0600L090B	73.1	91.1	91.1	141.1	140	1.1	6	4
	17	●	MHS0600L120B	103.1	121.1	121.1	171.1	170	1.1	6	4
	22	●	MHS0600L150B	133.1	151.1	151.1	201.1	200	1.1	6	4
6.1	2	□	MHS0610L030B	13.3	29.6	31.1	81.1	80	1.1	8	3
	7	□	MHS0610L060B	43.8	59.6	61.1	111.1	110	1.1	8	4
	12	□	MHS0610L090B	74.3	89.6	91.1	141.1	140	1.1	8	4
	17	□	MHS0610L120B	104.8	119.6	121.1	171.1	170	1.1	8	4
	22	□	MHS0610L150B	135.3	149.6	151.1	201.1	200	1.1	8	4
6.2	2	□	MHS0620L030B	13.5	29.6	31.1	81.1	80	1.1	8	3
	7	□	MHS0620L060B	44.5	59.6	61.1	111.1	110	1.1	8	4
	12	□	MHS0620L090B	75.5	89.6	91.1	141.1	140	1.1	8	4
	17	□	MHS0620L120B	106.5	119.6	121.1	171.1	170	1.1	8	4
	21	□	MHS0620L150B	131.3	149.6	151.1	201.1	200	1.1	8	4
6.3	2	□	MHS0630L030B	13.7	29.6	31.1	81.1	80	1.1	8	3
	7	□	MHS0630L060B	45.2	59.6	61.1	111.1	110	1.1	8	4
	12	□	MHS0630L090B	76.7	89.6	91.1	141.1	140	1.1	8	4
	16	□	MHS0630L120B	101.9	119.6	121.1	171.1	170	1.1	8	4
	21	□	MHS0630L150B	133.4	149.6	151.1	201.1	200	1.1	8	4
6.4	2	□	MHS0640L030B	13.9	29.6	31.1	81.1	80	1.1	8	3
	7	□	MHS0640L060B	46.0	59.7	61.2	111.2	110	1.2	8	4
	11	□	MHS0640L090B	71.6	89.7	91.2	141.2	140	1.2	8	4
	16	□	MHS0640L120B	103.6	119.7	121.2	171.2	170	1.2	8	4
	21	□	MHS0640L150B	135.6	149.7	151.2	201.2	200	1.2	8	4

DC (mm)	Głębokość otworu (L/D)	VP15TF	Numer zamówieniowy	Wymiary (mm)							Typ
				LU	LCF	LH	OAL	LF	PL	DCON	
6.5	2	●	MHS0650L030B	14.1	29.6	31.1	81.1	80	1.1	8	3
	6	●	MHS0650L060B	40.2	59.7	61.2	111.2	110	1.2	8	4
	11	●	MHS0650L090B	72.7	89.7	91.2	141.2	140	1.2	8	4
	16	●	MHS0650L120B	105.2	119.7	121.2	171.2	170	1.2	8	4
	20	●	MHS0650L150B	131.2	149.7	151.2	201.2	200	1.2	8	4
6.6	2	□	MHS0660L030B	14.3	30.1	31.1	81.1	80	1.1	8	3
	6	□	MHS0660L060B	40.8	60.2	61.2	111.2	110	1.2	8	4
	11	□	MHS0660L090B	73.8	90.2	91.2	141.2	140	1.2	8	4
	16	□	MHS0660L120B	106.8	120.2	121.2	171.2	170	1.2	8	4
	20	□	MHS0660L150B	133.2	150.2	151.2	201.2	200	1.2	8	4
6.7	2	□	MHS0670L030B	14.6	30.2	31.2	81.2	80	1.2	8	3
	6	□	MHS0670L060B	41.4	60.2	61.2	111.2	110	1.2	8	4
	11	□	MHS0670L090B	74.9	90.2	91.2	141.2	140	1.2	8	4
	15	□	MHS0670L120B	101.7	120.2	121.2	171.2	170	1.2	8	4
	20	□	MHS0670L150B	135.2	150.2	151.2	201.2	200	1.2	8	4
6.8	2	★	MHS0680L030B	14.8	30.2	31.2	81.2	80	1.2	8	3
	6	★	MHS0680L060B	42.0	60.2	61.2	111.2	110	1.2	8	4
	11	★	MHS0680L090B	76.0	90.2	91.2	141.2	140	1.2	8	4
	15	★	MHS0680L120B	103.2	120.2	121.2	171.2	170	1.2	8	4
	19	★	MHS0680L150B	130.4	150.2	151.2	201.2	200	1.2	8	4
6.9	2	□	MHS0690L030B	15.0	30.2	31.2	81.2	80	1.2	8	3
	6	□	MHS0690L060B	42.7	60.3	61.3	111.3	110	1.3	8	4
	10	□	MHS0690L090B	70.3	90.3	91.3	141.3	140	1.3	8	4
	15	□	MHS0690L120B	104.8	120.3	121.3	171.3	170	1.3	8	4
	19	□	MHS0690L150B	132.4	150.3	151.3	201.3	200	1.3	8	4
7.0	2	●	MHS0700L030B	15.2	30.2	31.2	81.2	80	1.2	8	3
	6	●	MHS0700L060B	43.3	60.3	61.3	111.3	110	1.3	8	4
	10	●	MHS0700L090B	71.3	90.3	91.3	141.3	140	1.3	8	4
	14	●	MHS0700L120B	99.3	120.3	121.3	171.3	170	1.3	8	4
	19	●	MHS0700L150B	134.3	150.3	151.3	201.3	200	1.3	8	4
7.1	2	□	MHS0710L030B	15.4	30.7	31.2	81.2	80	1.2	8	3
	6	□	MHS0710L060B	43.9	60.8	61.3	111.3	110	1.3	8	4
	10	□	MHS0710L090B	72.3	90.8	91.3	141.3	140	1.3	8	4
	14	□	MHS0710L120B	100.7	120.8	121.3	171.3	170	1.3	8	4
	19	□	MHS0710L150B	136.2	150.8	151.3	201.3	200	1.3	8	4
7.2	2	□	MHS0720L030B	15.6	30.7	31.2	81.2	80	1.2	8	3
	6	□	MHS0720L060B	44.5	60.8	61.3	111.3	110	1.3	8	4
	10	□	MHS0720L090B	73.3	90.8	91.3	141.3	140	1.3	8	4
	14	□	MHS0720L120B	102.1	120.8	121.3	171.3	170	1.3	8	4
	18	□	MHS0720L150B	130.9	150.8	151.3	201.3	200	1.3	8	4
7.2	25	□	MHS0720L200B	181.3	200.8	201.3	251.3	250	1.3	8	4

WIERCENIE (WIERTŁA PEŁNOWĘGLIKOWE)

MHS

WĘGLIKI
SPIEKANE

M
WIERCENIE

DC (mm)	Głębokość otworu (L/D)	VP15TF	Numer zamówieniowy	Wymiary (mm)							Typ
				LU	LCF	LH	OAL	LF	PL	DCON	
7.3	2	□	MHS0730L030B	15.9	30.8	31.3	81.3	80	1.3	8	3
	6	□	MHS0730L060B	45.1	60.8	61.3	111.3	110	1.3	8	4
	10	□	MHS0730L090B	74.3	90.8	91.3	141.3	140	1.3	8	4
	14	□	MHS0730L120B	103.5	120.8	121.3	171.3	170	1.3	8	4
	18	□	MHS0730L150B	132.7	150.8	151.3	201.3	200	1.3	8	4
	25	□	MHS0730L200B	183.8	200.8	201.3	251.3	250	1.3	8	4
7.4	1	□	MHS0740L030B	8.7	30.8	31.3	81.3	80	1.3	8	3
	6	□	MHS0740L060B	45.7	60.8	61.3	111.3	110	1.3	8	4
	10	□	MHS0740L090B	75.3	90.8	91.3	141.3	140	1.3	8	4
	14	□	MHS0740L120B	104.9	120.8	121.3	171.3	170	1.3	8	4
	18	□	MHS0740L150B	134.5	150.8	151.3	201.3	200	1.3	8	4
	24	□	MHS0740L200B	178.9	200.8	201.3	251.3	250	1.3	8	4
7.5	1	●	MHS0750L030B	8.8	30.8	31.3	81.3	80	1.3	8	3
	5	●	MHS0750L060B	38.9	60.9	61.4	111.4	110	1.4	8	4
	9	●	MHS0750L090B	68.9	90.9	91.4	141.4	140	1.4	8	4
	13	●	MHS0750L120B	98.9	120.9	121.4	171.4	170	1.4	8	4
	17	●	MHS0750L150B	128.9	150.9	151.4	201.4	200	1.4	8	4
	24	●	MHS0750L200B	181.4	200.9	201.4	251.4	250	1.4	8	4
7.6	1	□	MHS0760L030B	8.9	31.3	31.3	81.3	80	1.3	8	3
	5	□	MHS0760L060B	39.4	61.4	61.4	111.4	110	1.4	8	4
	9	□	MHS0760L090B	69.8	91.4	91.4	141.4	140	1.4	8	4
	13	□	MHS0760L120B	100.2	121.4	121.4	171.4	170	1.4	8	4
	17	□	MHS0760L150B	130.6	151.4	151.4	201.4	200	1.4	8	4
	24	□	MHS0760L200B	183.8	201.4	201.4	251.4	250	1.4	8	4
30	□	MHS0760L250B	229.4	251.4	251.4	301.4	300	1.4	8	4	
7.7	1	□	MHS0770L030B	9.0	31.3	31.3	81.3	80	1.3	8	3
	5	□	MHS0770L060B	39.9	61.4	61.4	111.4	110	1.4	8	4
	9	□	MHS0770L090B	70.7	91.4	91.4	141.4	140	1.4	8	4
	13	□	MHS0770L120B	101.5	121.4	121.4	171.4	170	1.4	8	4
	17	□	MHS0770L150B	132.3	151.4	151.4	201.4	200	1.4	8	4
	23	□	MHS0770L200B	178.5	201.4	201.4	251.4	250	1.4	8	4
30	□	MHS0770L250B	232.4	251.4	251.4	301.4	300	1.4	8	4	
7.8	1	★	MHS0780L030B	9.1	31.3	31.3	81.3	80	1.3	8	3
	5	★	MHS0780L060B	40.4	61.4	61.4	111.4	110	1.4	8	4
	9	★	MHS0780L090B	71.6	91.4	91.4	141.4	140	1.4	8	4
	13	★	MHS0780L120B	102.8	121.4	121.4	171.4	170	1.4	8	4
	17	★	MHS0780L150B	134.0	151.4	151.4	201.4	200	1.4	8	4
	23	★	MHS0780L200B	180.8	201.4	201.4	251.4	250	1.4	8	4
30	★	MHS0780L250B	235.4	251.4	251.4	301.4	300	1.4	8	4	
7.9	1	□	MHS0790L030B	9.3	31.4	31.4	81.4	80	1.4	8	3
	5	□	MHS0790L060B	40.9	61.4	61.4	111.4	110	1.4	8	4
	9	□	MHS0790L090B	72.5	91.4	91.4	141.4	140	1.4	8	4
	13	□	MHS0790L120B	104.1	121.4	121.4	171.4	170	1.4	8	4
	16	□	MHS0790L150B	127.8	151.4	151.4	201.4	200	1.4	8	4
	23	□	MHS0790L200B	183.1	201.4	201.4	251.4	250	1.4	8	4
29	□	MHS0790L250B	230.5	251.4	251.4	301.4	300	1.4	8	4	

DC (mm)	Głębokość otworu (L/D)	VP15TF	Numer zamówieniowy	Wymiary (mm)							Typ
				LU	LCF	LH	OAL	LF	PL	DCON	
8.0	1	●	MHS0800L030B	9.4	31.4	31.4	81.4	80	1.4	8	3
	5	●	MHS0800L060B	41.5	61.5	61.5	111.5	110	1.5	8	4
	9	●	MHS0800L090B	73.5	91.5	91.5	141.5	140	1.5	8	4
	12	●	MHS0800L120B	97.5	121.5	121.5	171.5	170	1.5	8	4
	16	●	MHS0800L150B	129.5	151.5	151.5	201.5	200	1.5	8	4
	22	●	MHS0800L200B	177.5	201.5	201.5	251.5	250	1.5	8	4
	29	●	MHS0800L250B	233.5	251.5	251.5	301.5	300	1.5	8	4
8.1	2	□	MHS0810L040B	17.6	39.9	41.4	101.4	100	1.4	10	3
	8	□	MHS0810L090B	66.3	90.0	91.5	151.5	150	1.5	10	4
	12	□	MHS0810L120B	98.7	120.0	121.5	181.5	180	1.5	10	4
	16	□	MHS0810L150B	131.1	150.0	151.5	211.5	210	1.5	10	4
	22	□	MHS0810L200B	179.7	200.0	201.5	261.5	260	1.5	10	4
	28	□	MHS0810L250B	228.3	250.0	251.5	311.5	310	1.5	10	4
8.2	2	□	MHS0820L040B	17.8	39.9	41.4	101.4	100	1.4	10	3
	8	□	MHS0820L090B	67.1	90.0	91.5	151.5	150	1.5	10	4
	12	□	MHS0820L120B	99.9	120.0	121.5	181.5	180	1.5	10	4
	16	□	MHS0820L150B	132.7	150.0	151.5	211.5	210	1.5	10	4
	22	□	MHS0820L200B	181.9	200.0	201.5	261.5	260	1.5	10	4
	28	□	MHS0820L250B	231.1	250.0	251.5	311.5	310	1.5	10	4
8.3	2	□	MHS0830L040B	18.0	39.9	41.4	101.4	100	1.4	10	3
	8	□	MHS0830L090B	67.9	90.0	91.5	151.5	150	1.5	10	4
	12	□	MHS0830L120B	101.1	120.0	121.5	181.5	180	1.5	10	4
	15	□	MHS0830L150B	126.0	150.0	151.5	211.5	210	1.5	10	4
	21	□	MHS0830L200B	175.8	200.0	201.5	261.5	260	1.5	10	4
	27	□	MHS0830L250B	225.6	250.0	251.5	311.5	310	1.5	10	4
8.4	2	□	MHS0840L040B	18.2	39.9	41.4	101.4	100	1.4	10	3
	8	□	MHS0840L090B	68.7	90.0	91.5	151.5	150	1.5	10	4
	12	□	MHS0840L120B	102.3	120.0	121.5	181.5	180	1.5	10	4
	15	□	MHS0840L150B	127.5	150.0	151.5	211.5	210	1.5	10	4
	21	□	MHS0840L200B	177.9	200.0	201.5	261.5	260	1.5	10	4
	27	□	MHS0840L250B	228.3	250.0	251.5	311.5	310	1.5	10	4
8.5	2	●	MHS0850L040B	18.5	40.0	41.5	101.5	100	1.5	10	3
	8	●	MHS0850L090B	69.5	90.0	91.5	151.5	150	1.5	10	4
	11	●	MHS0850L120B	95.0	120.0	121.5	181.5	180	1.5	10	4
	15	●	MHS0850L150B	129.0	150.0	151.5	211.5	210	1.5	10	4
	21	●	MHS0850L200B	180.0	200.0	201.5	261.5	260	1.5	10	4
	27	●	MHS0850L250B	231.0	250.0	251.5	311.5	310	1.5	10	4
8.6	2	□	MHS0860L040B	18.7	40.5	41.5	101.5	100	1.5	10	3
	8	□	MHS0860L090B	70.4	90.6	91.6	151.6	150	1.6	10	4
	11	□	MHS0860L120B	96.2	120.6	121.6	181.6	180	1.6	10	4
	15	□	MHS0860L150B	130.6	150.6	151.6	211.6	210	1.6	10	4
	21	□	MHS0860L200B	182.2	200.6	201.6	261.6	260	1.6	10	4
	26	□	MHS0860L250B	225.2	250.6	251.6	311.6	310	1.6	10	4
8.7	2	□	MHS0870L040B	18.9	40.5	41.5	101.5	100	1.5	10	3
	8	□	MHS0870L090B	71.2	90.6	91.6	151.6	150	1.6	10	4
	11	□	MHS0870L120B	97.3	120.6	121.6	181.6	180	1.6	10	4
	15	□	MHS0870L150B	132.1	150.6	151.6	211.6	210	1.6	10	4
	20	□	MHS0870L200B	175.6	200.6	201.6	261.6	260	1.6	10	4
	26	□	MHS0870L250B	227.8	250.6	251.6	311.6	310	1.6	10	4

Uwaga 1) Gdy geometria wiertła nie odpowiada wartościom podanym w tabeli (np. inna średnica i długość wiertła), prosimy o skontaktowanie się z naszą firmą.

● : Standard magazynowy. ★ : Na specjalne zamówienie z magazynu w Japonii.

□ : Niestandardowy, produkowany na specjalne zamówienie.

DC (mm)	Głębokość otworu (L/D)	VP15TF	Numer zamówieniowy	Wymiary (mm)							Typ
				LU	LCF	LH	OAL	LF	PL	DCON	
8.8	2	★	MHS0880L040B	19.1	40.5	41.5	101.5	100	1.5	10	3
	8	★	MHS0880L090B	72.0	90.6	91.6	151.6	150	1.6	10	4
	11	★	MHS0880L120B	98.4	120.6	121.6	181.6	180	1.6	10	4
	14	★	MHS0880L150B	124.8	150.6	151.6	211.6	210	1.6	10	4
	20	★	MHS0880L200B	177.6	200.6	201.6	261.6	260	1.6	10	4
	26	★	MHS0880L250B	230.4	250.6	251.6	311.6	310	1.6	10	4
8.9	2	□	MHS0890L040B	19.3	40.5	41.5	101.5	100	1.5	10	3
	7	□	MHS0890L090B	63.9	90.6	91.6	151.6	150	1.6	10	4
	11	□	MHS0890L120B	99.5	120.6	121.6	181.6	180	1.6	10	4
	14	□	MHS0890L150B	126.2	150.6	151.6	211.6	210	1.6	10	4
	20	□	MHS0890L200B	179.6	200.6	201.6	261.6	260	1.6	10	4
	25	□	MHS0890L250B	224.1	250.6	251.6	311.6	310	1.6	10	4
9.0	2	●	MHS0900L040B	19.5	40.5	41.5	101.5	100	1.5	10	3
	7	●	MHS0900L090B	64.6	90.6	91.6	151.6	150	1.6	10	4
	11	●	MHS0900L120B	100.6	120.6	121.6	181.6	180	1.6	10	4
	14	●	MHS0900L150B	127.6	150.6	151.6	211.6	210	1.6	10	4
	20	●	MHS0900L200B	181.6	200.6	201.6	261.6	260	1.6	10	4
	25	●	MHS0900L250B	226.6	250.6	251.6	311.6	310	1.6	10	4
9.1	2	□	MHS0910L040B	19.8	41.1	41.6	101.6	100	1.6	10	3
	7	□	MHS0910L090B	65.4	91.2	91.7	151.7	150	1.7	10	4
	11	□	MHS0910L120B	101.8	121.2	121.7	181.7	180	1.7	10	4
	14	□	MHS0910L150B	129.1	151.2	151.7	211.7	210	1.7	10	4
	19	□	MHS0910L200B	174.6	201.2	201.7	261.7	260	1.7	10	4
	25	□	MHS0910L250B	229.2	251.2	251.7	311.7	310	1.7	10	4
30	□	MHS0910L300B	274.7	301.2	301.7	361.7	360	1.7	10	4	
9.2	2	□	MHS0920L040B	20.0	41.1	41.6	101.6	100	1.6	10	3
	7	□	MHS0920L090B	66.1	91.2	91.7	151.7	150	1.7	10	4
	10	□	MHS0920L120B	93.7	121.2	121.7	181.7	180	1.7	10	4
	14	□	MHS0920L150B	130.5	151.2	151.7	211.7	210	1.7	10	4
	19	□	MHS0920L200B	176.5	201.2	201.7	261.7	260	1.7	10	4
	25	□	MHS0920L250B	231.7	251.2	251.7	311.7	310	1.7	10	4
30	□	MHS0920L300B	277.7	301.2	301.7	361.7	360	1.7	10	4	
9.3	2	□	MHS0930L040B	20.2	41.1	41.6	101.6	100	1.6	10	3
	7	□	MHS0930L090B	66.8	91.2	91.7	151.7	150	1.7	10	4
	10	□	MHS0930L120B	94.7	121.2	121.7	181.7	180	1.7	10	4
	14	□	MHS0930L150B	131.9	151.2	151.7	211.7	210	1.7	10	4
	19	□	MHS0930L200B	178.4	201.2	201.7	261.7	260	1.7	10	4
	24	□	MHS0930L250B	224.9	251.2	251.7	311.7	310	1.7	10	4
30	□	MHS0930L300B	280.7	301.2	301.7	361.7	360	1.7	10	4	
9.4	2	□	MHS0940L040B	20.4	41.1	41.6	101.6	100	1.6	10	3
	7	□	MHS0940L090B	67.5	91.2	91.7	151.7	150	1.7	10	4
	10	□	MHS0940L120B	95.7	121.2	121.7	181.7	180	1.7	10	4
	13	□	MHS0940L150B	123.9	151.2	151.7	211.7	210	1.7	10	4
	19	□	MHS0940L200B	180.3	201.2	201.7	261.7	260	1.7	10	4
	24	□	MHS0940L250B	227.3	251.2	251.7	311.7	310	1.7	10	4
29	□	MHS0940L300B	274.3	301.2	301.7	361.7	360	1.7	10	4	

DC (mm)	Głębokość otworu (L/D)	VP15TF	Numer zamówieniowy	Wymiary (mm)							Typ
				LU	LCF	LH	OAL	LF	PL	DCON	
9.5	2	★	MHS0950L040B	20.6	41.1	41.6	101.6	100	1.6	10	3
	7	★	MHS0950L090B	68.2	91.2	91.7	151.7	150	1.7	10	4
	10	★	MHS0950L120B	96.7	121.2	121.7	181.7	180	1.7	10	4
	13	★	MHS0950L150B	125.2	151.2	151.7	211.7	210	1.7	10	4
	18	★	MHS0950L200B	172.7	201.2	201.7	261.7	260	1.7	10	4
	24	★	MHS0950L250B	229.7	251.2	251.7	311.7	310	1.7	10	4
29	★	MHS0950L300B	277.2	301.2	301.7	361.7	360	1.7	10	4	
9.6	2	□	MHS0960L040B	20.9	41.7	41.7	101.7	100	1.7	10	3
	7	□	MHS0960L090B	68.9	91.7	91.7	151.7	150	1.7	10	4
	10	□	MHS0960L120B	97.7	121.7	121.7	181.7	180	1.7	10	4
	13	□	MHS0960L150B	126.5	151.7	151.7	211.7	210	1.7	10	4
	18	□	MHS0960L200B	174.5	201.7	201.7	261.7	260	1.7	10	4
	24	□	MHS0960L250B	232.1	251.7	251.7	311.7	310	1.7	10	4
29	□	MHS0960L300B	280.1	301.7	301.7	361.7	360	1.7	10	4	
9.7	2	□	MHS0970L040B	21.1	41.7	41.7	101.7	100	1.7	10	3
	7	□	MHS0970L090B	69.7	91.8	91.8	151.8	150	1.8	10	4
	10	□	MHS0970L120B	98.8	121.8	121.8	181.8	180	1.8	10	4
	13	□	MHS0970L150B	127.9	151.8	151.8	211.8	210	1.8	10	4
	18	□	MHS0970L200B	176.4	201.8	201.8	261.8	260	1.8	10	4
	23	□	MHS0970L250B	224.9	251.8	251.8	311.8	310	1.8	10	4
28	□	MHS0970L300B	273.4	301.8	301.8	361.8	360	1.8	10	4	
9.8	2	★	MHS0980L040B	21.3	41.7	41.7	101.7	100	1.7	10	3
	7	★	MHS0980L090B	70.4	91.8	91.8	151.8	150	1.8	10	4
	10	★	MHS0980L120B	99.8	121.8	121.8	181.8	180	1.8	10	4
	13	★	MHS0980L150B	129.2	151.8	151.8	211.8	210	1.8	10	4
	18	★	MHS0980L200B	178.2	201.8	201.8	261.8	260	1.8	10	4
	23	★	MHS0980L250B	227.2	251.8	251.8	311.8	310	1.8	10	4
28	★	MHS0980L300B	276.2	301.8	301.8	361.8	360	1.8	10	4	
9.9	2	□	MHS0990L040B	21.5	41.7	41.7	101.7	100	1.7	10	3
	7	□	MHS0990L090B	71.1	91.8	91.8	151.8	150	1.8	10	4
	10	□	MHS0990L120B	100.8	121.8	121.8	181.8	180	1.8	10	4
	13	□	MHS0990L150B	130.5	151.8	151.8	211.8	210	1.8	10	4
	18	□	MHS0990L200B	180.0	201.8	201.8	261.8	260	1.8	10	4
	23	□	MHS0990L250B	229.5	251.8	251.8	311.8	310	1.8	10	4
28	□	MHS0990L300B	279.0	301.8	301.8	361.8	360	1.8	10	4	
10.0	1	●	MHS1000L040B	11.7	41.7	41.7	101.7	100	1.7	10	3
	6	●	MHS1000L090B	61.8	91.8	91.8	151.8	150	1.8	10	4
	9	●	MHS1000L120B	91.8	121.8	121.8	181.8	180	1.8	10	4
	12	●	MHS1000L150B	121.8	151.8	151.8	211.8	210	1.8	10	4
	17	●	MHS1000L200B	171.8	201.8	201.8	261.8	260	1.8	10	4
	22	●	MHS1000L250B	221.8	251.8	251.8	311.8	310	1.8	10	4
27	●	MHS1000L300B	271.8	301.8	301.8	361.8	360	1.8	10	4	
10.1	1	□	MHS1010L040B	11.8	40.2	41.7	101.7	100	1.7	12	3
	6	□	MHS1010L090B	62.4	90.3	91.8	151.8	150	1.8	12	4
	9	□	MHS1010L120B	92.7	120.3	121.8	181.8	180	1.8	12	4
	12	□	MHS1010L150B	123.0	150.3	151.8	211.8	210	1.8	12	4
	17	□	MHS1010L200B	173.5	200.3	201.8	261.8	260	1.8	12	4
	22	□	MHS1010L250B	224.0	250.3	251.8	311.8	310	1.8	12	4
27	□	MHS1010L300B	274.5	300.3	301.8	361.8	360	1.8	12	4	

WIERCENIE (WIERTŁA PEŁNOWĘGLIKOWE)

MHS

WĘGLIKI
SPIEKANE

M
WIERCENIE

DC (mm)	Głębokość otworu (L/D)	VP15TF	Numer zamówieniowy	Wymiary (mm)							Typ
				LU	LCF	LH	OAL	LF	PL	DCON	
10.2	1	<input type="checkbox"/>	MHS1020L040B	12.0	40.3	41.8	101.8	100	1.8	12	3
	6	<input type="checkbox"/>	MHS1020L090B	63.1	90.4	91.9	151.9	150	1.9	12	4
	9	<input type="checkbox"/>	MHS1020L120B	93.7	120.4	121.9	181.9	180	1.9	12	4
	12	<input type="checkbox"/>	MHS1020L150B	124.3	150.4	151.9	211.9	210	1.9	12	4
	17	<input type="checkbox"/>	MHS1020L200B	175.3	200.4	201.9	261.9	260	1.9	12	4
	22	<input type="checkbox"/>	MHS1020L250B	226.3	250.4	251.9	311.9	310	1.9	12	4
	27	<input type="checkbox"/>	MHS1020L300B	277.3	300.4	301.9	361.9	360	1.9	12	4
10.3	1	<input type="checkbox"/>	MHS1030L040B	12.1	40.3	41.8	101.8	100	1.8	12	3
	6	<input type="checkbox"/>	MHS1030L090B	63.7	90.4	91.9	151.9	150	1.9	12	4
	9	<input type="checkbox"/>	MHS1030L120B	94.6	120.4	121.9	181.9	180	1.9	12	4
	12	<input type="checkbox"/>	MHS1030L150B	125.5	150.4	151.9	211.9	210	1.9	12	4
	17	<input type="checkbox"/>	MHS1030L200B	177.0	200.4	201.9	261.9	260	1.9	12	4
	22	<input type="checkbox"/>	MHS1030L250B	228.5	250.4	251.9	311.9	310	1.9	12	4
	26	<input type="checkbox"/>	MHS1030L300B	269.7	300.4	301.9	361.9	360	1.9	12	4
10.4	1	<input type="checkbox"/>	MHS1040L040B	12.2	40.3	41.8	101.8	100	1.8	12	3
	6	<input type="checkbox"/>	MHS1040L090B	64.3	90.4	91.9	151.9	150	1.9	12	4
	9	<input type="checkbox"/>	MHS1040L120B	95.5	120.4	121.9	181.9	180	1.9	12	4
	12	<input type="checkbox"/>	MHS1040L150B	126.7	150.4	151.9	211.9	210	1.9	12	4
	17	<input type="checkbox"/>	MHS1040L200B	178.7	200.4	201.9	261.9	260	1.9	12	4
	21	<input type="checkbox"/>	MHS1040L250B	220.3	250.4	251.9	311.9	310	1.9	12	4
	26	<input type="checkbox"/>	MHS1040L300B	272.3	300.4	301.9	361.9	360	1.9	12	4
10.5	1	<input checked="" type="checkbox"/>	MHS1050L040B	12.3	40.3	41.8	101.8	100	1.8	12	3
	6	<input checked="" type="checkbox"/>	MHS1050L090B	64.9	90.4	91.9	151.9	150	1.9	12	4
	9	<input checked="" type="checkbox"/>	MHS1050L120B	96.4	120.4	121.9	181.9	180	1.9	12	4
	12	<input checked="" type="checkbox"/>	MHS1050L150B	127.9	150.4	151.9	211.9	210	1.9	12	4
	16	<input checked="" type="checkbox"/>	MHS1050L200B	169.9	200.4	201.9	261.9	260	1.9	12	4
	21	<input checked="" type="checkbox"/>	MHS1050L250B	222.4	250.4	251.9	311.9	310	1.9	12	4
	26	<input checked="" type="checkbox"/>	MHS1050L300B	274.9	300.4	301.9	361.9	360	1.9	12	4
10.6	1	<input type="checkbox"/>	MHS1060L040B	12.4	40.8	41.8	101.8	100	1.8	12	3
	6	<input type="checkbox"/>	MHS1060L090B	65.5	90.9	91.9	151.9	150	1.9	12	4
	9	<input type="checkbox"/>	MHS1060L120B	97.3	120.9	121.9	181.9	180	1.9	12	4
	12	<input type="checkbox"/>	MHS1060L150B	129.1	150.9	151.9	211.9	210	1.9	12	4
	16	<input type="checkbox"/>	MHS1060L200B	171.5	200.9	201.9	261.9	260	1.9	12	4
	21	<input type="checkbox"/>	MHS1060L250B	224.5	250.9	251.9	311.9	310	1.9	12	4
	26	<input type="checkbox"/>	MHS1060L300B	277.5	300.9	301.9	361.9	360	1.9	12	4
10.7	1	<input type="checkbox"/>	MHS1070L040B	12.5	40.8	41.8	101.8	100	1.8	12	3
	6	<input type="checkbox"/>	MHS1070L090B	66.1	90.9	91.9	151.9	150	1.9	12	4
	9	<input type="checkbox"/>	MHS1070L120B	98.2	120.9	121.9	181.9	180	1.9	12	4
	11	<input type="checkbox"/>	MHS1070L150B	119.6	150.9	151.9	211.9	210	1.9	12	4
	16	<input type="checkbox"/>	MHS1070L200B	173.1	200.9	201.9	261.9	260	1.9	12	4
	21	<input type="checkbox"/>	MHS1070L250B	226.6	250.9	251.9	311.9	310	1.9	12	4
	25	<input type="checkbox"/>	MHS1070L300B	269.4	300.9	301.9	361.9	360	1.9	12	4
10.8	1	<input checked="" type="checkbox"/>	MHS1080L040B	12.7	40.9	41.9	101.9	100	1.9	12	3
	6	<input checked="" type="checkbox"/>	MHS1080L090B	66.8	91.0	92.0	152.0	150	2.0	12	4
	9	<input checked="" type="checkbox"/>	MHS1080L120B	99.2	121.0	122.0	182.0	180	2.0	12	4
	11	<input checked="" type="checkbox"/>	MHS1080L150B	120.8	151.0	152.0	212.0	210	2.0	12	4
	16	<input checked="" type="checkbox"/>	MHS1080L200B	174.8	201.0	202.0	262.0	260	2.0	12	4
	21	<input checked="" type="checkbox"/>	MHS1080L250B	228.8	251.0	252.0	312.0	310	2.0	12	4
	25	<input checked="" type="checkbox"/>	MHS1080L300B	272.0	301.0	302.0	362.0	360	2.0	12	4

DC (mm)	Głębokość otworu (L/D)	VP15TF	Numer zamówieniowy	Wymiary (mm)							Typ
				LU	LCF	LH	OAL	LF	PL	DCON	
10.9	1	<input type="checkbox"/>	MHS1090L040B	12.8	40.9	41.9	101.9	100	1.9	12	3
	6	<input type="checkbox"/>	MHS1090L090B	67.4	91.0	92.0	152.0	150	2.0	12	4
	8	<input type="checkbox"/>	MHS1090L120B	89.2	121.0	122.0	182.0	180	2.0	12	4
	11	<input type="checkbox"/>	MHS1090L150B	121.9	151.0	152.0	212.0	210	2.0	12	4
	16	<input type="checkbox"/>	MHS1090L200B	176.4	201.0	202.0	262.0	260	2.0	12	4
	20	<input type="checkbox"/>	MHS1090L250B	220.0	251.0	252.0	312.0	310	2.0	12	4
	25	<input type="checkbox"/>	MHS1090L300B	274.5	301.0	302.0	362.0	360	2.0	12	4
11.0	1	<input checked="" type="checkbox"/>	MHS1100L040B	12.9	40.9	41.9	101.9	100	1.9	12	3
	6	<input checked="" type="checkbox"/>	MHS1100L090B	68.0	91.0	92.0	152.0	150	2.0	12	4
	8	<input checked="" type="checkbox"/>	MHS1100L120B	90.0	121.0	122.0	182.0	180	2.0	12	4
	11	<input checked="" type="checkbox"/>	MHS1100L150B	123.0	151.0	152.0	212.0	210	2.0	12	4
	16	<input checked="" type="checkbox"/>	MHS1100L200B	178.0	201.0	202.0	262.0	260	2.0	12	4
	20	<input checked="" type="checkbox"/>	MHS1100L250B	222.0	251.0	252.0	312.0	310	2.0	12	4
	25	<input checked="" type="checkbox"/>	MHS1100L300B	277.0	301.0	302.0	362.0	360	2.0	12	4
11.1	1	<input type="checkbox"/>	MHS1110L040B	13.0	41.4	41.9	101.9	100	1.9	12	3
	6	<input type="checkbox"/>	MHS1110L090B	68.6	91.5	92.0	152.0	150	2.0	12	4
	8	<input type="checkbox"/>	MHS1110L120B	90.8	121.5	122.0	182.0	180	2.0	12	4
	11	<input type="checkbox"/>	MHS1110L150B	124.1	151.5	152.0	212.0	210	2.0	12	4
	15	<input type="checkbox"/>	MHS1110L200B	168.5	201.5	202.0	262.0	260	2.0	12	4
	20	<input type="checkbox"/>	MHS1110L250B	224.0	251.5	252.0	312.0	310	2.0	12	4
	24	<input type="checkbox"/>	MHS1110L300B	268.4	301.5	302.0	362.0	360	2.0	12	4
11.2	1	<input type="checkbox"/>	MHS1120L040B	13.1	41.4	41.9	101.9	100	1.9	12	3
	5	<input type="checkbox"/>	MHS1120L090B	58.0	91.5	92.0	152.0	150	2.0	12	4
	8	<input type="checkbox"/>	MHS1120L120B	91.6	121.5	122.0	182.0	180	2.0	12	4
	11	<input type="checkbox"/>	MHS1120L150B	125.2	151.5	152.0	212.0	210	2.0	12	4
	15	<input type="checkbox"/>	MHS1120L200B	170.0	201.5	202.0	262.0	260	2.0	12	4
	20	<input type="checkbox"/>	MHS1120L250B	226.0	251.5	252.0	312.0	310	2.0	12	4
	24	<input type="checkbox"/>	MHS1120L300B	270.8	301.5	302.0	362.0	360	2.0	12	4
11.3	1	<input type="checkbox"/>	MHS1130L040B	13.2	41.4	41.9	101.9	100	1.9	12	3
	5	<input type="checkbox"/>	MHS1130L090B	58.6	91.6	92.1	152.1	150	2.1	12	4
	8	<input type="checkbox"/>	MHS1130L120B	92.5	121.6	122.1	182.1	180	2.1	12	4
	11	<input type="checkbox"/>	MHS1130L150B	126.4	151.6	152.1	212.1	210	2.1	12	4
	15	<input type="checkbox"/>	MHS1130L200B	171.6	201.6	202.1	262.1	260	2.1	12	4
	20	<input type="checkbox"/>	MHS1130L250B	228.1	251.6	252.1	312.1	310	2.1	12	4
	24	<input type="checkbox"/>	MHS1130L300B	273.3	301.6	302.1	362.1	360	2.1	12	4
11.4	1	<input type="checkbox"/>	MHS1140L040B	13.4	41.5	42.0	102.0	100	2.0	12	3
	5	<input type="checkbox"/>	MHS1140L090B	59.1	91.6	92.1	152.1	150	2.1	12	4
	8	<input type="checkbox"/>	MHS1140L120B	93.3	121.6	122.1	182.1	180	2.1	12	4
	11	<input type="checkbox"/>	MHS1140L150B	127.5	151.6	152.1	212.1	210	2.1	12	4
	15	<input type="checkbox"/>	MHS1140L200B	173.1	201.6	202.1	262.1	260	2.1	12	4
	19	<input type="checkbox"/>	MHS1140L250B	218.7	251.6	252.1	312.1	310	2.1	12	4
	24	<input type="checkbox"/>	MHS1140L300B	275.7	301.6	302.1	362.1	360	2.1	12	4
11.5	1	<input checked="" type="checkbox"/>	MHS1150L040B	13.5	41.5	42.0	102.0	100	2.0	12	3
	5	<input checked="" type="checkbox"/>	MHS1150L090B	59.6	91.6	92.1	152.1	150	2.1	12	4
	8	<input checked="" type="checkbox"/>	MHS1150L120B	94.1	121.6	122.1	182.1	180	2.1	12	4
	10	<input checked="" type="checkbox"/>	MHS1150L150B	117.1	151.6	152.1	212.1	210	2.1	12	4
	15	<input checked="" type="checkbox"/>	MHS1150L200B	174.6	201.6	202.1	262.1	260	2.1	12	4
	19	<input checked="" type="checkbox"/>	MHS1150L250B	220.6	251.6	252.1	312.1	310	2.1	12	4
	24	<input checked="" type="checkbox"/>	MHS1150L300B	278.1	301.6	302.1	362.1	360	2.1	12	4

Uwaga 1) Gdy geometria wiertła nie odpowiada wartościom podanym w tabeli (np. inna średnica i długość wiertła), prosimy o skontaktowanie się z naszą firmą.

● : Standard magazynowy. ★ : Na specjalne zamówienie z magazynu w Japonii.

□ : Niestandardowy, produkowany na specjalne zamówienie.

DC (mm)	Ciężkość ołowiu (L/D)	VP15TF	Numer zamówieniowy	Wymiary (mm)							Typ
				LU	LCF	LH	OAL	LF	PL	DCON	
11.6	1	□	MHS1160L040B	13.6	42.0	42.0	102.0	100	2.0	12	3
	5	□	MHS1160L090B	60.1	92.1	92.1	152.1	150	2.1	12	4
	8	□	MHS1160L120B	94.9	122.1	122.1	182.1	180	2.1	12	4
	10	□	MHS1160L150B	118.1	152.1	152.1	212.1	210	2.1	12	4
	15	□	MHS1160L200B	176.1	202.1	202.1	262.1	260	2.1	12	4
	19	□	MHS1160L250B	222.5	252.1	252.1	312.1	310	2.1	12	4
	23	□	MHS1160L300B	268.9	302.1	302.1	362.1	360	2.1	12	4
11.7	1	□	MHS1170L040B	13.7	42.0	42.0	102.0	100	2.0	12	3
	5	□	MHS1170L090B	60.6	92.1	92.1	152.1	150	2.1	12	4
	8	□	MHS1170L120B	95.7	122.1	122.1	182.1	180	2.1	12	4
	10	□	MHS1170L150B	119.1	152.1	152.1	212.1	210	2.1	12	4
	15	□	MHS1170L200B	177.6	202.1	202.1	262.1	260	2.1	12	4
	19	□	MHS1170L250B	224.4	252.1	252.1	312.1	310	2.1	12	4
	23	□	MHS1170L300B	271.2	302.1	302.1	362.1	360	2.1	12	4
11.8	1	★	MHS1180L040B	13.8	42.0	42.0	102.0	100	2.0	12	3
	5	★	MHS1180L090B	61.1	92.1	92.1	152.1	150	2.1	12	4
	8	★	MHS1180L120B	96.5	122.1	122.1	182.1	180	2.1	12	4
	10	★	MHS1180L150B	120.1	152.1	152.1	212.1	210	2.1	12	4
	14	★	MHS1180L200B	167.3	202.1	202.1	262.1	260	2.1	12	4
	19	★	MHS1180L250B	226.3	252.1	252.1	312.1	310	2.1	12	4
	23	★	MHS1180L300B	273.5	302.1	302.1	362.1	360	2.1	12	4
11.9	1	□	MHS1190L040B	13.9	42.0	42.0	102.0	100	2.0	12	3
	5	□	MHS1190L090B	61.7	92.2	92.2	152.2	150	2.2	12	4
	8	□	MHS1190L120B	97.4	122.2	122.2	182.2	180	2.2	12	4
	10	□	MHS1190L150B	121.2	152.2	152.2	212.2	210	2.2	12	4
	14	□	MHS1190L200B	168.8	202.2	202.2	262.2	260	2.2	12	4
	19	□	MHS1190L250B	228.3	252.2	252.2	312.2	310	2.2	12	4
	23	□	MHS1190L300B	275.9	302.2	302.2	362.2	360	2.2	12	4
12.0	1	●	MHS1200L040B	14.1	42.1	42.1	102.1	100	2.1	12	3
	5	●	MHS1200L090B	62.2	92.2	92.2	152.2	150	2.2	12	4
	7	●	MHS1200L120B	86.2	122.2	122.2	182.2	180	2.2	12	4
	10	●	MHS1200L150B	122.2	152.2	152.2	212.2	210	2.2	12	4
	14	●	MHS1200L200B	170.2	202.2	202.2	262.2	260	2.2	12	4
	18	●	MHS1200L250B	218.2	252.2	252.2	312.2	310	2.2	12	4
	22	●	MHS1200L300B	266.2	302.2	302.2	362.2	360	2.2	12	4

ZALECANE PARAMETRY SKRAWANIA

Średnica wiertła DC (mm)	P				M			
	Prędkość skrawania (m/min)	Obroty (min ⁻¹)	Posuw (min.—maks.) (mm/obr.)	Posuw stołu (mm/min)	Prędkość skrawania (m/min)	Obroty (min ⁻¹)	Posuw (min.—maks.) (mm/obr.)	Posuw stołu (mm/min)
1.0	40	12700	0.030 (0.020—0.040)	380	20	6400	0.030 (0.020—0.040)	190
1.2	50	13300	0.035 (0.025—0.050)	465	30	8000	0.035 (0.025—0.050)	280
1.6	60	11900	0.050 (0.030—0.065)	595	40	8000	0.050 (0.030—0.065)	400
2.0	70	11100	0.060 (0.040—0.080)	665	50	8000	0.060 (0.040—0.080)	480
2.5	80	10200	0.075 (0.050—0.100)	765	60	7600	0.075 (0.050—0.100)	570
3.2	80	8000	0.100 (0.070—0.130)	800	60	6000	0.100 (0.070—0.130)	600
4.0	80	6400	0.100 (0.090—0.110)	640	60	4800	0.090 (0.080—0.090)	430
5.0	80	5100	0.130 (0.110—0.140)	665	60	3800	0.110 (0.100—0.120)	420
6.3	80	4000	0.160 (0.140—0.180)	640	60	3000	0.140 (0.130—0.150)	420
8.0	80	3200	0.200 (0.180—0.230)	640	60	2400	0.170 (0.160—0.190)	410
10.0	80	2600	0.250 (0.220—0.280)	650	60	1900	0.220 (0.200—0.230)	420
12.0	80	2100	0.300 (0.270—0.340)	630	60	1600	0.260 (0.240—0.280)	415

Średnica wiertła DC (mm)	P				H	M			
	Prędkość skrawania (m/min)	Obroty (min ⁻¹)	Posuw (min.—maks.) (mm/obr.)	Posuw stołu (mm/min)	Prędkość skrawania (m/min)	Obroty (min ⁻¹)	Posuw (min.—maks.) (mm/obr.)	Posuw stołu (mm/min)	
1.0	20	6400	0.025 (0.020—0.030)	160	40	12700	0.020 (0.015—0.025)	255	
1.2	30	8000	0.030 (0.020—0.035)	240	40	10600	0.025 (0.020—0.030)	265	
1.6	40	8000	0.040 (0.030—0.045)	320	50	10000	0.035 (0.025—0.040)	350	
2.0	50	8000	0.045 (0.035—0.060)	360	50	8000	0.040 (0.030—0.050)	320	
2.5	60	7600	0.060 (0.045—0.075)	455	60	7600	0.050 (0.040—0.065)	380	
3.2	60	6000	0.080 (0.060—0.090)	480	60	6000	0.060 (0.050—0.080)	360	
4.0	60	4800	0.080 (0.070—0.100)	385	60	4800	0.080 (0.060—0.100)	385	
5.0	60	3800	0.110 (0.090—0.130)	420	60	3800	0.100 (0.080—0.130)	380	
6.3	60	3000	0.130 (0.110—0.160)	390	60	3000	0.110 (0.090—0.130)	330	
8.0	60	2400	0.170 (0.140—0.200)	410	60	2400	0.140 (0.120—0.160)	335	
10.0	60	1900	0.210 (0.170—0.250)	400	60	1900	0.170 (0.140—0.200)	325	
12.0	60	1600	0.250 (0.210—0.300)	400	60	1600	0.210 (0.170—0.240)	335	

Średnica wiertła DC (mm)	H				S
	Prędkość skrawania (m/min)	Obroty (min ⁻¹)	Posuw (min.—maks.) (mm/obr.)	Posuw stołu (mm/min)	
1.0	10	3200	0.015 (0.015—0.020)	50	
1.2	10	2700	0.020 (0.015—0.025)	55	
1.6	10	2000	0.025 (0.020—0.030)	50	
2.0	20	3200	0.035 (0.025—0.040)	110	
2.5	20	2600	0.040 (0.030—0.050)	105	
3.2	20	2000	0.050 (0.040—0.070)	100	
4.0	30	2400	0.070 (0.050—0.080)	170	
5.0	30	1900	0.080 (0.060—0.100)	150	
6.3	30	1500	0.090 (0.080—0.110)	135	
8.0	40	1600	0.120 (0.100—0.130)	190	
10.0	40	1300	0.150 (0.130—0.170)	195	
12.0	40	1100	0.180 (0.150—0.200)	200	

Uwaga 1) W przypadku stosowania wiertła o stosunku L/D powyżej 10, wykonać otwory pilotowe. (bez otworu pilotowego wiertło może złamać się.)

Uwaga 2) Jako wiertła pilotowego użyć wiertła o odpowiedniej średnicy i najkrótszym rowku wiórowym.

WSKAZÓWKI EKSPLOATACYJNE

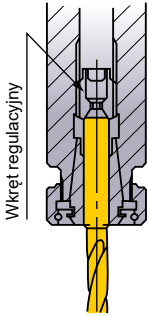
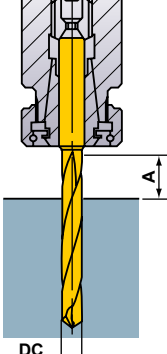
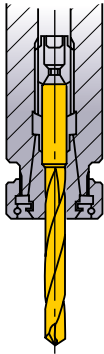
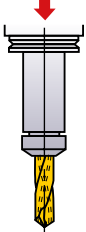
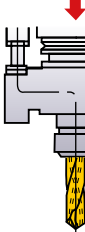
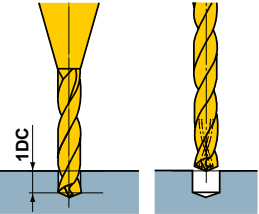
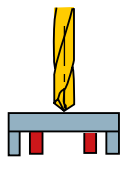
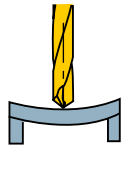
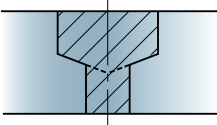
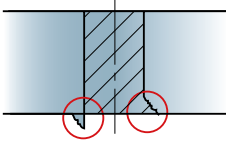
<p>Zamocowanie wiertła</p>  <p>Uchwyt z tuleją wciągana i łożyskiem oporowym silnie mocuje narzędzie.</p>	<p>Długość wiertła</p>  <p>$A \geq DC \times 2$</p>	<p>Montaż wiertła</p>  <p>Nie mocować wiertła za rowek wiórowy.</p>	<p>Typ z przelotowym kanałem doprowadzenia chłodziwa</p>  <p>Typ z wirującym kanałem doprowadzenia chłodziwa</p>  <p>Ciśnienie chłodziwa wynosi ok. 15 bar – 70 bar Zalecane ciśnienie chłodziwa: ≥ 30 bar</p>
<p>Montaż wiertła</p>  <ol style="list-style-type: none"> Wykonać otwór pilotowy o średn. ok. 1DC (DC: średnica wiertła) używając najkrótszego wiertła MHS. Wierząc wiertłem z kanałem chłodziwa, wykonany wcześniej otwór wykorzystać jako otwór prowadzący. W zależności od aplikacji zastosować wiercenie przerywane. 	<p>Postępowanie z chłodziwem</p> <ol style="list-style-type: none"> Cząstki brudu i kurzu w używanym chłodziwie zatykają kanał doprowadzenia chłodziwa i uniemożliwiają jego skuteczny przepływ. Zalecana jest regularna wymiana chłodziwa. Małe cząstki opiłków zatykają kanał doprowadzenia chłodziwa. Profilaktycznie zawsze używać filtra. Wierząc wiertłem o małej średnicy, używać filtra o małym numerze sita. 	<p>Cienkie przedmioty obrabiane</p>  <p>OK</p> <p>Umieścić przedmiot obrabiany na podpórcie</p>  <p>X</p> <p>W razie wystąpienia zginania</p>	<p>Obróbka przerywana</p> <p>Proces jednozabiegowy</p> <p>OK</p> <p>① Podczas wiercenia detalu stopniowanego zmniejszyć posuw.</p> <p>Wymaga wstępnego wiercenia</p> <p>② Przed wierceniem wykonać spłaszczenie frezem trzpieniowym</p>
<p>Otworki stopniowane</p>  <ol style="list-style-type: none"> Podzielić proces obróbki na dwa zabiegi. Najpierw wywiercić otwór o większej średnicy. <p>*Narzędzia do fazowania i pogłębiania czolowego mogą być wykonane na zamówienie.order.</p>	<p>Stępienie ostrych krawędzi i fazowanie przedmiotu obrabianego</p>  <ol style="list-style-type: none"> W momencie wyjścia z materiału zmniejszyć posuw. Zmienić kąt wierzchołkowy. 		

■ WSKAZÓWKI EKSPLOATACYJNE DLA WIERTEŁ DŁUGICH TYPU MHS (L/D ≥ 10)

WIERCENIE PRZEDMIOTÓW O PŁASKIEJ POWIERZCHNI CZOŁOWEJ ● Wiercenie otworu nieprzelotowego

■ 1. Wiercenie otworu pilotowego

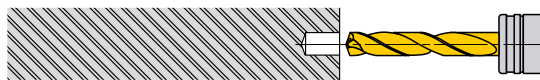

- ① Użyć wiertła o większym kącie wierzchołkowym (bardziej płaskiego), niż dla wiertła super długiego. Użyć wiertła o możliwie najkrótszym rowku wiórowym.
- ② Zapewnić wykonanie wysokodokładnego otworu pilotowego, aby proces wiercenia głębokich otworów przebiegał bez problemów
- ③ Głębokość wiercenia otworu pilotowego: ok. 1DC albo większa. (Głębokość otworu pilotowego dostosować do długości wiertła.)

■ 2. Wiercenie wstępne wiertłem długim



- ① Wiercić wstępnie otwór pilotowy przy małych obrotach. (Obroty 1000min⁻¹, posuw 0.2–0.3mm/obr)
- ② Zakończyć wiercenie wiertłem do głębokich otworów na 0.5–1mm przed dnem otworu pilotowego.

■ 3. Wiercenie głębokiego otworu

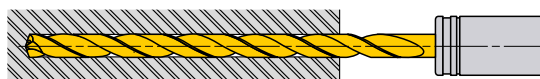

- ① Zwiększyć obroty i posuw w jednym cyklu i wiercić, aż do uzyskania żądanej głębokości otworu.

■ 4. Wycofanie wiertła

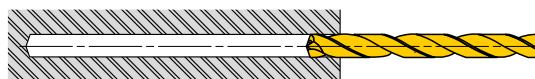

- ① Po wierceniu zmniejszyć obroty na 0.5–1mm przed końcem otworu. (Obroty około 1000min⁻¹)
- ② Wycofać wiertło na głębokość początkową otworu pilotowego przy prędkości posuwu 3000mm/min.
- ③ Wycofać wiertło z otworu pilotowego przy obrotach (n=300, Vf=3000mm/min.)

WIERCENIE PRZERYWANE ● Wiercenie otworów w płaszczyznach nieregularnych lub pod kątem

■ 1. Frezowanie pogłębienia prostopadłego do kierunku wiercenia



- ① Obrabiać płaską lub nieregularną powierzchnię frezem palcowym lub frezem do rowków wpustowych o tej samej średnicy, jak wymagana średnica otworu.

■ 2. Wiercenie otworu pilotowego



- ① Użyć wiertła o większym kącie wierzchołkowym (bardziej płaskiego), niż dla wiertła super długiego. Użyć wiertła o możliwie najkrótszym rowku wiórowym.
- ② Zapewnić wykonanie wysokodokładnego otworu pilotowego, aby proces wiercenia głębokich otworów przebiegał bez problemów
- ③ Głębokość wiercenia otworu pilotowego: ok. 1DC albo większa. (Głębokość otworu pilotowego dostosować do długości wiertła.)

■ 3. Wiercenie wstępne wiertłem długim



- ① Wprowadzić wiertło w otwór pilotowy przy małych obrotach (prędkość skrawania 20–30m/min, posuw 0,2–0,3 mm/obr).
- ② Zatrzymać wiertło 1mm–3 mm przed dnem otworu pilotowego.

■ 4. Wiercenie głębokiego otworu

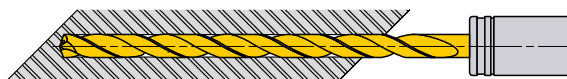

- ① Zwiększyć obroty i posuw w jednym cyklu i wiercić, aż do uzyskania żądanej głębokości otworu.

■ 5. Wyjście z materiału

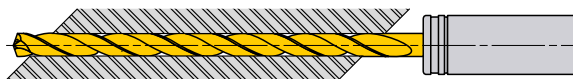

- ① Podczas wychodzenia z materiału istnieje niebezpieczeństwo uszkodzenia krawędzi skrawającej wiertła.
- ② W momencie wyjścia z materiału zmniejszyć posuw.

■ 6. Wycofanie wiertła



- ① Wycofać wiertło do punktu początkowego otworu pilotowego przy prędkości posuwu 3000mm/min.

WIERCENIE (WIERTŁA Z PŁYTKĄ CENTRALNĄ)

STAW

- Falista krawędź skrawająca zapewnia dobre formowanie wióra.
- System zamocowania o dużej sztywności zapewnia stabilność i niezawodność podczas wiercenia.



WĘGLIKI
SPIEKANE

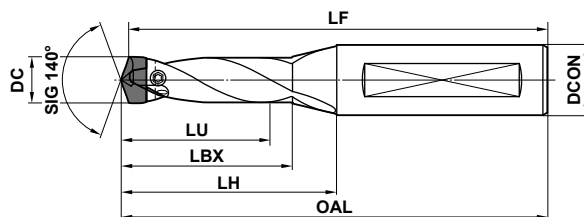

M
WIERCENIE

OPRAWKI

DC (mm)	Głębokość otworu (LD)	Oprawka		Wymiary (mm)						F Typ klucza	Płytki		
		Numer zamówieniowy	Dostępność	LU	LBX	LH	OAL	LF	DCON		DC (mm)	Numer zamówieniowy	Dostępność VP15TF
10.0 10.4	1.5	STAWSS1000S16	●	16.8	23.8	33.8	81.8	80	16	TIP06F	10.0	* STAWN1000TH STAWK1000TG	●
	3	STAWSN1000S16	●	31.8	38.8	48.8	96.8	95	16	TIP06F	10.1	STAWN1010TH STAWK1010TG	●
	5	STAWMN1000S16	●	51.8	58.8	68.8	116.8	115	16	TIP06F	10.2	STAWN1020TH STAWK1020TG	●
	8	STAWLN1000S16	●	81.8	88.8	98.8	146.8	145	16	TIP06F	10.3 10.4	STAWN1030TH STAWK1030TG STAWN1040TH STAWK1040TG	●
10.5 10.9	1.5	STAWSS1050S16	●	17.7	23.9	33.9	81.9	80	16	TIP06F	10.5	* STAWN1050TH STAWK1050TG	●
	3	STAWSN1050S16	●	33.4	38.9	48.9	96.9	95	16	TIP06F	10.6	STAWN1060TH STAWK1060TG	●
	5	STAWMN1050S16	●	54.4	58.9	68.9	116.9	115	16	TIP06F	10.7	STAWN1070TH STAWK1070TG	●
	8	STAWLN1050S16	●	85.9	88.9	98.9	146.9	145	16	TIP06F	10.8 10.9	STAWN1080TH STAWK1080TG STAWN1090TH STAWK1090TG	●
11.0 11.4	1.5	STAWSS1100S16	●	18.5	27.0	38.0	86.0	84	16	TIP06F	11.0	* STAWN1100TH STAWK1100TG	●
	3	STAWSN1100S16	●	35.0	43.0	54.0	102.0	100	16	TIP06F	11.1	STAWN1110TH STAWK1110TG	●
	5	STAWMN1100S16	●	57.0	68.0	79.0	127.0	125	16	TIP06F	11.2	STAWN1120TH STAWK1120TG	●
	8	STAWLN1100S16	●	90.0	98.0	109.0	157.0	155	16	TIP06F	11.3 11.4	STAWN1130TH STAWK1130TG STAWN1140TH STAWK1140TG	●
11.5 11.9	1.5	STAWSS1150S16	●	19.4	27.1	38.1	86.1	84	16	TIP06F	11.5	* STAWN1150TH STAWK1150TG	●
	3	STAWSN1150S16	●	36.6	43.1	54.1	102.1	100	16	TIP06F	11.6	STAWN1160TH STAWK1160TG	●
	5	STAWMN1150S16	●	59.6	68.1	79.1	127.1	125	16	TIP06F	11.7	STAWN1170TH STAWK1170TG	●
	8	STAWLN1150S16	●	94.1	98.1	109.1	157.1	155	16	TIP06F	11.8 11.9	STAWN1180TH STAWK1180TG STAWN1190TH STAWK1190TG	●
12.0 12.4	1.5	STAWSS1200S16	●	20.2	29.2	41.2	89.2	87	16	TIP06F	12.0	* STAWN1200TH STAWK1200TG	●
	3	STAWSN1200S16	●	38.2	47.2	59.2	107.2	105	16	TIP06F	12.1	STAWN1210TH STAWK1210TG	●
	5	STAWMN1200S16	●	62.2	72.2	84.2	132.2	130	16	TIP06F	12.2	STAWN1220TH STAWK1220TG	●
	8	STAWLN1200S16	●	98.2	107.2	119.2	167.2	165	16	TIP06F	12.3 12.4	STAWN1230TH STAWK1230TG STAWN1240TH STAWK1240TG	●

Uwaga 1) Wymiary oznaczone (*) dotyczą wiertła z zamontowaną płytką.

Uwaga 2) Gdy geometria wiertła nie odpowiada wartościom podanym w tabeli (np. inna średnica i długość wiertła), prosimy o skontaktowanie się z naszą firmą.

● : Standard magazynowy.

(Uwaga: w opakowaniu znajduje się 1 płytki)

OZNACZENIE PŁYTKI > M144

PARAMETRY SKRAWANIA > M146

UWAGI DOTYCZĄCE ZASTOSOWANIA > M147

CZĘŚCI ZAPASOWE > N001

INFORMACJE TECHNICZNE > P001

M141

WIERCENIE (WIERTŁA Z PŁYTKĄ CENTRALNĄ)

STAW

WĘGLIKI
SPIEKANE

M

WIERCENIE

DC (mm)	Głębokość otworu (L/D)	Oprawka		Wymiary (mm)						F W		Płytką		
		Numer zamówieniowy	Dostępność	LU	LBX	LH	OAL	LF	DCON	Typ klucza	DC (mm)	Numer zamówieniowy	Dostępność	
													VP15TF	
12.5 12.9	1.5	STAWSS1250S16	●	21.1	29.3	41.3	89.3	87	16	TIP06F	12.5	* STAWN1250TH STAWK1250TG	●	
	3	STAWSN1250S16	●	39.8	47.3	59.3	107.3	105	16	TIP06F	12.6	STAWN1260TH STAWK1260TG	●	
	5	STAWMN1250S16	●	64.8	72.3	84.3	132.3	130	16	TIP06F	12.7	STAWN1270TH STAWK1270TG	●	
	8	STAWLN1250S16	●	102.3	107.3	119.3	167.3	165	16	TIP06F	12.8	STAWN1280TH STAWK1280TG	●	
											12.9	STAWN1290TH STAWK1290TG	●	
13.0 13.4	1.5	STAWSS1300S16	●	21.9	32.4	45.4	93.4	91	16	TIP08W	13.0	* STAWN1300TH STAWK1300TG	●	
	3	STAWSN1300S16	●	41.4	51.4	64.4	112.4	110	16	TIP08W	13.1	STAWN1310TH STAWK1310TG	●	
	5	STAWMN1300S16	●	67.4	76.4	89.4	137.4	135	16	TIP08W	13.2	STAWN1320TH STAWK1320TG	●	
	8	STAWLN1300S16	●	106.4	116.4	129.4	177.4	175	16	TIP08W	13.3	STAWN1330TH STAWK1330TG	●	
											13.4	STAWN1340TH STAWK1340TG	●	
13.5 13.9	1.5	STAWSS1350S16	●	22.8	32.5	45.5	93.5	91	16	TIP08W	13.5	* STAWN1350TH STAWK1350TG	●	
	3	STAWSN1350S16	●	43.0	51.5	64.5	112.5	110	16	TIP08W	13.6	STAWN1360TH STAWK1360TG	●	
	5	STAWMN1350S16	●	70.0	76.5	89.5	137.5	135	16	TIP08W	13.7	STAWN1370TH STAWK1370TG	●	
	8	STAWLN1350S16	●	110.5	116.5	129.5	177.5	175	16	TIP08W	13.8	STAWN1380TH STAWK1380TG	●	
											13.9	STAWN1390TH STAWK1390TG	●	
14.0 14.4	1.5	STAWSS1400S16	●	23.5	33.5	47.5	95.5	93	16	TIP08W	14.0	* STAWN1400TH STAWK1400TG	●	
	3	STAWSN1400S16	●	44.5	55.5	69.5	117.5	115	16	TIP08W	14.1	STAWN1410TH STAWK1410TG	●	
	5	STAWMN1400S16	●	72.5	85.5	99.5	147.5	145	16	TIP08W	14.2	STAWN1420TH STAWK1420TG	●	
	8	STAWLN1400S16	●	114.5	124.5	139.5	187.5	185	16	TIP08W	14.3	STAWN1430TH STAWK1430TG	●	
											14.4	STAWN1440TH STAWK1440TG	●	
14.5 14.9	1.5	STAWSS1450S16	●	24.4	33.6	47.6	95.6	93	16	TIP08W	14.5	* STAWN1450TH STAWK1450TG	●	
	3	STAWSN1450S16	●	46.1	55.6	69.6	117.6	115	16	TIP08W	14.6	STAWN1460TH STAWK1460TG	●	
	5	STAWMN1450S16	●	75.1	85.6	99.6	147.6	145	16	TIP08W	14.7	STAWN1470TH STAWK1470TG	●	
	8	STAWLN1450S16	●	118.6	124.6	139.6	187.6	185	16	TIP08W	14.8	STAWN1480TH STAWK1480TG	●	
											14.9	STAWN1490TH STAWK1490TG	●	
15.0 15.4	1.5	STAWSS1500S20	●	25.2	35.7	50.7	100.7	98	20	TIP08W	15.0	* STAWN1500TH STAWK1500TG	●	
	3	STAWSN1500S20	●	47.7	62.7	77.7	127.7	125	20	TIP08W	15.1	STAWN1510TH STAWK1510TG	●	
	5	STAWMN1500S20	●	77.7	92.7	107.7	157.7	155	20	TIP08W	15.2	STAWN1520TH STAWK1520TG	●	
	8	STAWLN1500S20	●	122.7	132.7	150.7	200.7	198	20	TIP08W	15.3	STAWN1530TH STAWK1530TG	●	
											15.4	STAWN1540TH STAWK1540TG	●	

Uwaga 1) Wymiary oznaczone (*) dotyczą wiertła z zamontowaną płytką.

Uwaga 2) Gdy geometria wiertła nie odpowiada wartościom podanym w tabeli (np. inna średnica i długość wiertła), prosimy o skontaktowanie się z naszą firmą.

● : Standard magazynowy. (Uwaga: w opakowaniu znajduje się 1 płytką)

DC (mm)	Głębokość otworu (L/D)	Oprawka		Wymiary (mm)						W  Typ klucza	Płytki		
		Numer zamówieniowy	Dostępność	LU	LBX	LH	OAL	LF	DCON		DC (mm)	Numer zamówieniowy	Dostępność VP15TF
15.5 16.4	1.5	STAWSS1600S20	●	26.1	36.8	52.8	102.8	100	20	TIP10W	15.5	* STAWN1550T	●
												STAWK1550TG	
											15.6	STAWN1560T	●
											15.7	STAWN1570T	●
												STAWK1570TG	
											15.8	STAWN1580T	●
												STAWK1580TG	
											15.9	STAWN1590T	●
												STAWK1590TG	
											16.0	STAWN1600T	●
												STAWK1600TG	
										16.1	STAWN1610T	●	
											STAWK1610TG		
										16.2	STAWN1620T	●	
											STAWK1620TG		
										16.3	STAWN1630T	●	
											STAWK1630TG		
										16.4	STAWN1640T	●	
											STAWK1640TG		
16.5 17.4	1.5	STAWSS1700S20	●	27.8	39.0	56.0	106.0	103	20	TIP10W	16.5	* STAWN1650T	●
												STAWK1650TG	
											16.6	STAWN1660T	●
												STAWK1660TG	
											16.7	STAWN1670T	●
												STAWK1670TG	
											16.8	STAWN1680T	●
												STAWK1680TG	
											16.9	STAWN1690T	●
												STAWK1690TG	
											17.0	STAWN1700T	●
												STAWK1700TG	
										17.1	STAWN1710T	●	
											STAWK1710TG		
										17.2	STAWN1720T	●	
											STAWK1720TG		
										17.3	STAWN1730T	●	
											STAWK1730TG		
										17.4	STAWN1740T	●	
											STAWK1740TG		
17.5 18.4	1.5	STAWSS1800S20	●	29.5	40.2	58.2	108.2	105	20	TIP10W	17.5	* STAWN1750T	●
												STAWK1750TG	
											17.6	STAWN1760T	●
												STAWK1760TG	
											17.7	STAWN1770T	●
												STAWK1770TG	
											17.8	STAWN1780T	●
												STAWK1780TG	
											17.9	STAWN1790T	●
												STAWK1790TG	
											18.0	STAWN1800T	●
												STAWK1800TG	
										18.1	STAWN1810T	●	
											STAWK1810TG		
										18.2	STAWN1820T	●	
											STAWK1820TG		
										18.3	STAWN1830T	●	
											STAWK1830TG		
										18.4	STAWN1840T	●	
											STAWK1840TG		

OZNACZENIE PŁYTKI > M144
 PARAMETRY SKRAWANIA > M146
 UWAGI DOTYCZĄCE ZASTOSOWANIA > M147

CZĘŚCI ZAPASOWE > N001
 INFORMACJE TECHNICZNE > P001

STAW

PŁYTKI

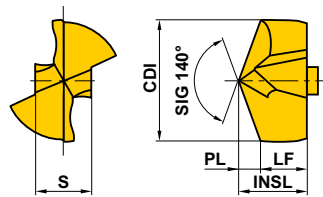

M

WIERCENIE

Numer zamówieniowy	Pokrywany		Wymiary (mm)					Wiertło
	VP15TF		CDI	INSL	LF	PL	S	
STAWN1000TH	●		10.0	5.6	3.8	1.8	4.6	STAWSS1000S16 STAWSN1000S16 STAWMN1000S16 STAWLN1000S16
STAWN1010TH	●		10.1	5.6	3.8	1.8	4.6	
STAWN1020TH	●		10.2	5.7	3.8	1.9	4.6	
STAWN1030TH	●		10.3	5.7	3.8	1.9	4.6	
STAWN1040TH	●		10.4	5.7	3.8	1.9	4.6	
STAWN1050TH	●		10.5	5.9	4.0	1.9	4.8	STAWSS1050S16 STAWSN1050S16 STAWMN1050S16 STAWLN1050S16
STAWN1060TH	●		10.6	5.9	4.0	1.9	4.8	
STAWN1070TH	●		10.7	5.9	4.0	1.9	4.8	
STAWN1080TH	●		10.8	6.0	4.0	2.0	4.8	
STAWN1090TH	●		10.9	6.0	4.0	2.0	4.8	
STAWN1100TH	●		11.0	6.2	4.2	2.0	5.1	STAWSS1100S16 STAWSN1100S16 STAWMN1100S16 STAWLN1100S16
STAWN1110TH	●		11.1	6.2	4.2	2.0	5.1	
STAWN1120TH	●		11.2	6.2	4.2	2.0	5.1	
STAWN1130TH	●		11.3	6.3	4.2	2.1	5.1	
STAWN1140TH	●		11.4	6.3	4.2	2.1	5.1	
STAWN1150TH	●		11.5	6.5	4.4	2.1	5.3	STAWSS1150S16 STAWSN1150S16 STAWMN1150S16 STAWLN1150S16
STAWN1160TH	●		11.6	6.5	4.4	2.1	5.3	
STAWN1170TH	●		11.7	6.5	4.4	2.1	5.3	
STAWN1180TH	●		11.8	6.5	4.4	2.1	5.3	
STAWN1190TH	●		11.9	6.6	4.4	2.2	5.3	
STAWN1200TH	●		12.0	6.8	4.6	2.2	5.5	STAWSS1200S16 STAWSN1200S16 STAWMN1200S16 STAWLN1200S16
STAWN1210TH	●		12.1	6.8	4.6	2.2	5.5	
STAWN1220TH	●		12.2	6.8	4.6	2.2	5.5	
STAWN1230TH	●		12.3	6.8	4.6	2.2	5.5	
STAWN1240TH	●		12.4	6.9	4.6	2.3	5.5	
STAWN1250TH	●		12.5	7.1	4.8	2.3	5.8	STAWSS1250S16 STAWSN1250S16 STAWMN1250S16 STAWLN1250S16
STAWN1260TH	●		12.6	7.1	4.8	2.3	5.8	
STAWN1270TH	●		12.7	7.1	4.8	2.3	5.8	
STAWN1280TH	●		12.8	7.1	4.8	2.3	5.8	
STAWN1290TH	●		12.9	7.1	4.8	2.3	5.8	
STAWN1300TH	●		13.0	7.3	4.9	2.4	6.0	STAWSS1300S16 STAWSN1300S16 STAWMN1300S16 STAWLN1300S16
STAWN1310TH	●		13.1	7.3	4.9	2.4	6.0	
STAWN1320TH	●		13.2	7.3	4.9	2.4	6.0	
STAWN1330TH	●		13.3	7.3	4.9	2.4	6.0	
STAWN1340TH	●		13.4	7.3	4.9	2.4	6.0	
STAWN1350TH	●		13.5	7.6	5.1	2.5	6.2	STAWSS1350S16 STAWSN1350S16 STAWMN1350S16 STAWLN1350S16
STAWN1360TH	●		13.6	7.6	5.1	2.5	6.2	
STAWN1370TH	●		13.7	7.6	5.1	2.5	6.2	
STAWN1380TH	●		13.8	7.6	5.1	2.5	6.2	
STAWN1390TH	●		13.9	7.6	5.1	2.5	6.2	

● : Standard magazynowy. (Uwaga: w opakowaniu znajduje się 1 płytka)

Numer zamówieniowy	Pokrywany		Wymiary (mm)					Wiertło
	VP15TF		CDI	INSL	LF	PL	S	
STAWN1400TH	●		14.0	7.8	5.3	2.5	6.4	STAWSS1400S16 STAWSN1400S16 STAWMN1400S16 STAWLN1400S16
STAWN1410TH	●		14.1	7.9	5.3	2.6	6.4	
STAWN1420TH	●		14.2	7.9	5.3	2.6	6.4	
STAWN1430TH	●		14.3	7.9	5.3	2.6	6.4	
STAWN1440TH	●		14.4	7.9	5.3	2.6	6.4	
STAWN1450TH	●		14.5	8.1	5.5	2.6	6.7	STAWSS1450S16 STAWSN1450S16 STAWMN1450S16 STAWLN1450S16
STAWN1460TH	●		14.6	8.2	5.5	2.7	6.7	
STAWN1470TH	●		14.7	8.2	5.5	2.7	6.7	
STAWN1480TH	●		14.8	8.2	5.5	2.7	6.7	
STAWN1490TH	●		14.9	8.2	5.5	2.7	6.7	
STAWN1500TH	●		15.0	8.4	5.7	2.7	6.9	STAWSS1500S20 STAWSN1500S20 STAWMN1500S20 STAWLN1500S20
STAWN1510TH	●		15.1	8.4	5.7	2.7	6.9	
STAWN1520TH	●		15.2	8.5	5.7	2.8	6.9	
STAWN1530TH	●		15.3	8.5	5.7	2.8	6.9	
STAWN1540TH	●		15.4	8.5	5.7	2.8	6.9	
STAWN1550T	●		15.5	8.7	5.9	2.8	7.1	STAWSS1600S20 STAWSN1600S20 STAWMN1600S20 STAWLN1600S20
STAWN1560T	●		15.6	8.7	5.9	2.8	7.1	
STAWN1570T	●		15.7	8.8	5.9	2.9	7.1	
STAWN1580T	●		15.8	8.8	5.9	2.9	7.1	
STAWN1590T	●		15.9	8.8	5.9	2.9	7.1	
STAWN1600T	●		16.0	8.8	5.9	2.9	7.1	
STAWN1610T	●		16.1	8.8	5.9	2.9	7.1	
STAWN1620T	●		16.2	8.8	5.9	2.9	7.1	
STAWN1630T	●		16.3	8.9	5.9	3.0	7.1	
STAWN1640T	●		16.4	8.9	5.9	3.0	7.1	
STAWN1650T	●		16.5	9.3	6.3	3.0	7.6	STAWSS1700S20 STAWSN1700S20 STAWMN1700S20 STAWLN1700S20
STAWN1660T	●		16.6	9.3	6.3	3.0	7.6	
STAWN1670T	●		16.7	9.3	6.3	3.0	7.6	
STAWN1680T	●		16.8	9.4	6.3	3.1	7.6	
STAWN1690T	●		16.9	9.4	6.3	3.1	7.6	
STAWN1700T	●		17.0	9.4	6.3	3.1	7.6	
STAWN1710T	●		17.1	9.4	6.3	3.1	7.6	
STAWN1720T	●		17.2	9.4	6.3	3.1	7.6	
STAWN1730T	●		17.3	9.4	6.3	3.1	7.6	
STAWN1740T	●		17.4	9.5	6.3	3.2	7.6	
STAWN1750T	●		17.5	9.9	6.7	3.2	8.1	STAWSS1800S20 STAWSN1800S20 STAWMN1800S20 STAWLN1800S20
STAWN1760T	●		17.6	9.9	6.7	3.2	8.1	
STAWN1770T	●		17.7	9.9	6.7	3.2	8.1	
STAWN1780T	●		17.8	9.9	6.7	3.2	8.1	
STAWN1790T	●		17.9	10.0	6.7	3.3	8.1	
STAWN1800T	●		18.0	10.0	6.7	3.3	8.1	
STAWN1810T	●		18.1	10.0	6.7	3.3	8.1	
STAWN1820T	●		18.2	10.0	6.7	3.3	8.1	
STAWN1830T	●		18.3	10.0	6.7	3.3	8.1	
STAWN1840T	●		18.4	10.0	6.7	3.3	8.1	

STAW

WĘGLIKI
SPIEKANE

M

WIERCENIE

SZEROKOŚĆ ZASZLIFOWANIA

Jeżeli konieczne jest użycie płytki z zaszlifowaniem niestandardowym, przy zamawianiu prosimy o używanie następujących symboli.

(Numer zamówieniowy płytki)

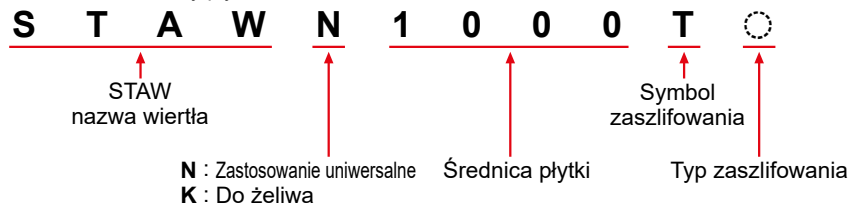

(Zaszlifowania standardowe)

Typ zaszlifowania	Szerokość zaszlifowania (mm)
F	0
G	0.02–0.05
H	0.05–0.10
- (Standard)	0.10–0.15
K	0.15–0.20
S	0.20–0.25
M	0.25–0.30

ZALECANE PARAMETRY SKRAWANIA

Materiał przedmiotu obrabianego	Średnica wiertła	φ10.0–φ12.9		φ13.0–φ13.9		φ14.0–φ15.4		φ15.5–φ18.4	
		Parametry	Prędkość skrawania (m/min)	Posuw (mm/obr.)	Prędkość skrawania (m/min)	Posuw (mm/obr.)	Prędkość skrawania (m/min)	Posuw (mm/obr.)	Prędkość skrawania (m/min)
P Stal konstrukcyjna	≤180HB	80	0.20	90	0.25	100	0.30	100	0.35
		(60–100)	(0.15–0.25)	(70–110)	(0.20–0.30)	(80–120)	(0.25–0.35)	(80–120)	(0.25–0.40)
	180–280HB	80	0.20	90	0.25	100	0.30	100	0.35
Stal węglowa Stal stopowa	280–350HB	70	0.20	80	0.25	90	0.25	90	0.30
	(60–90)	(0.15–0.25)	(60–100)	(0.20–0.30)	(70–110)	(0.20–0.30)	(70–110)	(0.20–0.35)	
M Stal nierdzewna	≤200HB	40	0.13	50	0.15	60	0.17	60	0.17
K Żeliwo	Wytrzymałość na rozciąganie ≤350MPa	80	0.20	90	0.25	100	0.30	120	0.45
		(60–100)	(0.15–0.25)	(70–110)	(0.20–0.30)	(80–120)	(0.25–0.35)	(80–140)	(0.35–0.55)
Żeliwo sferoidalne (GGG)	Wytrzymałość na rozciąganie ≤450MPa	70	0.20	80	0.25	90	0.30	100	0.35
		(60–90)	(0.15–0.25)	(60–100)	(0.20–0.30)	(70–110)	(0.25–0.35)	(80–120)	(0.25–0.40)

Uwaga 1) Gdy otwór ma głębokość DCx1.5, posuw wiertła można zwiększyć o około 20%.

Uwaga 2) Dla oprawki DCx8 zmniejszyć prędkość skrawania o około 20%.

Uwaga 3) Dla oprawki DCx8 zalecane jest wiercenie otworu pilotowego.

Uwaga 4) W przypadku wiercenia w stali nierdzewnej prosimy użyć chłodziwa.

(Nie zaleca się obróbki z minimalnym smarowaniem (MQL) ani chłodzenia mgłą olejową).

UWAGI EKSPLOATACYJNE

■ MONTAŻ PŁYTKI

1. Przed zamontowaniem płytki w oprawce sprawdzić, czy w kanałku lub szczelinie oprawki nie ma jakichś ciał obcych. W razie potrzeby przedmuchać sprężonym powietrzem.
2. Za pomocą dostarczonego klucza poluzować śrubę zaciskową, aby otworzyć końcówkę oprawki a następnie wsadzić płytkę w kanałek w oprawce, jak pokazano na Rys. 1.
*Podczas dokręcania łba śruby wewnętrznej klucz powinien być dosunięty do dna gniazda śruby.
3. Po wsadzeniu płytki w kanałek oprawki, dokręcić śrubę zaciskową, jednocześnie lekko dociskając płytkę do dna wybrania, jak pokazano na Rys. 2, celem dokładnego osadzenia i zamocowania płytki.
*Podczas dokręcania łba śruby wewnętrznej klucz powinien być dosunięty do dna gniazda śruby.

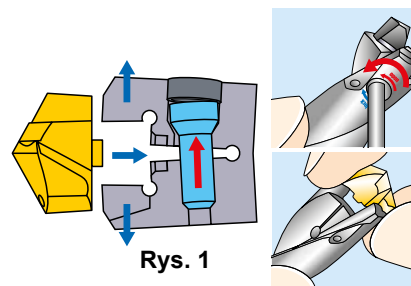
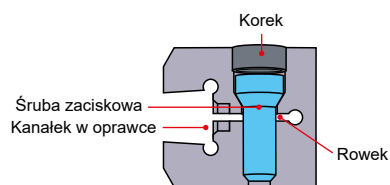

Rys. 1

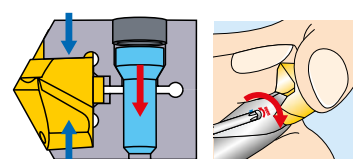

Rys. 2

Dokręcić śrubę zaciskową zachowując podany niżej moment.

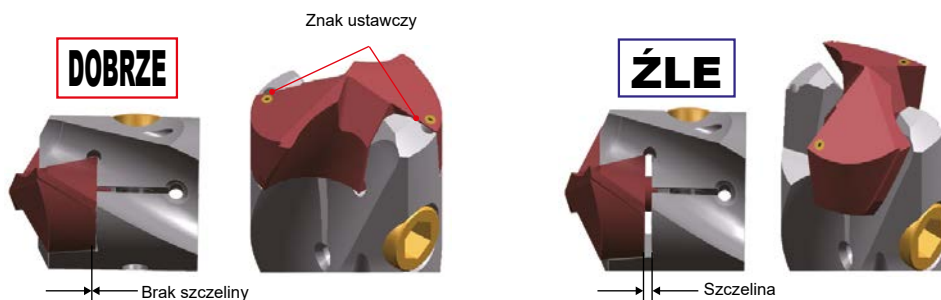

Średnica wiertła (mm)	Moment dokręcenia	
	N•m	
10 – 12.9	1	
13 – 15.4	2	
15.5 – 18.4	2.5	

4. Sprawdzić, czy między dnem oprawki a płytką nie ma szczeliny.



Uwaga 1) Złe lub niewłaściwe zamocowanie płytki może skutkować mniejszą wydajnością wiercenia i/lub złamaniem wiertła. Dlatego znaki ustawcze na oprawce i na płytce powinny być ustawione naprzeciwko siebie. Podczas wiercenia używać osłon i okularów ochronnych.

CZĘŚCI ZAPASOWE

Wiertło	Numer zamówieniowy opakowania (Śruba zaciskowa i korek)		
		Śruba zaciskowa	Korek
STAWSS/SN/MN/LN1000S16	WS203107TPS-35LH	WS203107TPS	WS35LH
STAWSS/SN/MN/LN1050S16	WS203107TPS-35LH	WS203107TPS	WS35LH
STAWSS/SN/MN/LN1100S16	WS203108TPS-35LH	WS203108TPS	WS35LH
STAWSS/SN/MN/LN1150S16	WS203108TPS-35LH	WS203108TPS	WS35LH
STAWSS/SN/MN/LN1200S16	WS203108TPS-35LH	WS203108TPS	WS35LH
STAWSS/SN/MN/LN1250S16	WS203108TPS-35LH	WS203108TPS	WS35LH
STAWSS/SN/MN/LN1300S16	WS253909TPS-45LH	WS253909TPS	WS45LH
STAWSS/SN/MN/LN1350S16	WS253909TPS-45LH	WS253909TPS	WS45LH
STAWSS/SN/MN/LN1400S16	WS253909TPS-45LH	WS253909TPS	WS45LH
STAWSS/SN/MN/LN1450S16	WS253909TPS-45LH	WS253909TPS	WS45LH
STAWSS/SN/MN/LN1500S20	WS253909TPS-45LH	WS253909TPS	WS45LH
STAWSS/SN/MN/LN1600S20	WS304912TPS-55LH	WS304912TPS	WS55LH
STAWSS/SN/MN/LN1700S20	WS304912TPS-55LH	WS304912TPS	WS55LH
STAWSS/SN/MN/LN1800S20	WS304912TPS-55LH	WS304912TPS	WS55LH

Uwaga 1) Opakowanie zawiera śrubę zaciskową, korek oraz instrukcję wymiany. Wymianę należy wykonywać zgodnie z instrukcją.

Notatki

A series of horizontal dashed lines for writing notes, spanning the width of the page.

WIERCENIE (WIERTŁA Z PŁYTKĄ CENTRALNĄ)

TAW

- Falista krawędź skrawająca zapewnia dobre formowanie wióra.
- Kanałki umożliwiają precyzyjne mocowanie płytki.
- Łatwa wymiana płytki.



WĘGLIKI
SPIEKANE



(Zastosowanie uniwersalne)

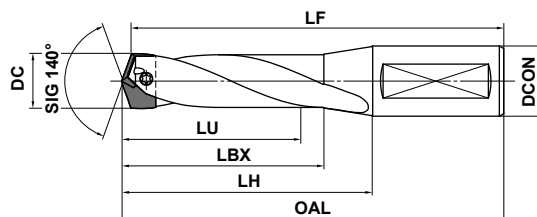

M

WIERCENIE

OPRAWKI

DC (mm)	Głębokość otworu (L/D)	Oprawka		Wymiary (mm)						Wkręt dociskowy	Typ klucza	Płytki czyszcząca	Smar zapobiegający zakładowi	Płytki				
		Numer zamówieniowy	Dostępność	LU	LBX	LH	OAL	LF	DCON					DC (mm)	Numer zamówieniowy	Dostępność		
														VP15TF	VP10H			
18.5 19.4	3	TAWSN1900S25	●	58.9	71.4	102.4	158.4	155.0	25	WS304517T	TKY10T	WPT4405	MK1KS	18.5	* TAWNH1850T	●	<input type="checkbox"/>	
															TAWKH1850TG			
														18.6	TAWNH1860T	●	<input type="checkbox"/>	
															TAWKH1860TG			
														18.7	TAWNH1870T	●	<input type="checkbox"/>	
															TAWKH1870TG			
		5	TAWMN1900S25	●	95.9	110.4	137.4	193.4	190.0	25	WS304517T	TKY10T	WPT4405	MK1KS	18.8	TAWNH1880T	●	<input type="checkbox"/>
		TAWKH1880TG																
	18.9	TAWNH1890T													●	<input type="checkbox"/>		
		TAWKH1890TG																
	19.0	TAWNH1900T													●	<input type="checkbox"/>		
		TAWKH1900TG																
	8	TAWLN1900S25	●	151.4	165.4	188.4	244.4	241.0	25	WS304517T	TKY10T	WPT4405	MK1KS	19.1	TAWNH1910T	●	<input type="checkbox"/>	
	TAWKH1910TG																	
19.2	TAWNH1920T													●	<input type="checkbox"/>			
	TAWKH1920TG																	
19.3	TAWNH1930T													●	<input type="checkbox"/>			
	TAWKH1930TG																	
19.5 20.4	3	TAWSN2000S25	●	62.0	75.5	102.5	158.5	155.0	25	WS304518T	TKY10T	WPT4405	MK1KS	19.4	TAWNH1940T	●	<input type="checkbox"/>	
															TAWKH1940TG			
														19.5	* TAWNH1950T	●	<input type="checkbox"/>	
															TAWKH1950TG			
														19.6	TAWNH1960T	●	<input type="checkbox"/>	
															TAWKH1960TG			
		5	TAWMN2000S25	●	101.0	116.5	142.5	198.5	195.0	25	WS304518T	TKY10T	WPT4405	MK1KS	19.7	TAWNH1970T	●	<input type="checkbox"/>
		TAWKH1970TG																
	19.8	TAWNH1980T													●	<input type="checkbox"/>		
		TAWKH1980TG																
	19.9	TAWNH1990T													●	<input type="checkbox"/>		
		TAWKH1990TG																
	8	TAWLN2000S25	●	159.5	173.5	196.5	252.5	249.0	25	WS304518T	TKY10T	WPT4405	MK1KS	20.0	TAWNH2000T	●	<input type="checkbox"/>	
	TAWKH2000TG																	
20.1	TAWNH2010T													<input type="checkbox"/>	<input type="checkbox"/>			
	TAWKH2010TG																	
20.2	TAWNH2020T													<input type="checkbox"/>	<input type="checkbox"/>			
	TAWKH2020TG																	
	8	TAWLN2000S25	●	159.5	173.5	196.5	252.5	249.0	25	WS304518T	TKY10T	WPT4405	MK1KS	20.3	TAWNH2030T	<input type="checkbox"/>	<input type="checkbox"/>	
	TAWKH2030TG																	
20.4	TAWNH2040T													<input type="checkbox"/>	<input type="checkbox"/>			
	TAWKH2040TG																	

Uwaga 1) Wymiary oznaczone (*) dotyczą wiertła z zamontowaną płytką.

Uwaga 2) Gdy geometria wiertła nie odpowiada wartościom podanym w tabeli (np. inna średnica i długość wiertła), prosimy o skontaktowanie się z naszą firmą.

- : Standard magazynowy. : Niestandardowy, produkowany na specjalne zamówienie.
- (Uwaga: w opakowaniu znajduje się 1 płytki)

DC (mm)	Głębokość otworu (L/D)	Oprawka		Wymiary (mm)										Płytki																
		Numer zamówieniowy	Dostępność	LU	LBX	LH	OAL	LF	DCON					DC (mm)	Numer zamówieniowy	Dostępność														
																VP15TF	VP10H													
20.5 21.4	3	TAWSN2100S25	●	65.2	78.7	102.7	158.7	155.0	25	WS304518T	TKY10T	WPT4405	MK1KS	20.5	* TAWNH2050T	●	<input type="checkbox"/>													
															TAWKH2050TG															
														20.6	TAWNH2060T	<input type="checkbox"/>	<input type="checkbox"/>													
															TAWKH2060TG															
														20.7	TAWNH2070T	<input type="checkbox"/>	<input type="checkbox"/>													
															TAWKH2070TG															
	20.8	TAWNH2080T	<input type="checkbox"/>	<input type="checkbox"/>																										
		TAWKH2080TG																												
	5	TAWMN2100S25	●	106.2	121.7	142.7	198.7	195.0	25	WS304518T	TKY10T	WPT4405	MK1KS	20.9	TAWNH2090T	<input type="checkbox"/>	<input type="checkbox"/>													
															TAWKH2090TG															
														21.0	TAWNH2100T	●	<input type="checkbox"/>													
															TAWKH2100TG															
21.1														TAWNH2110T	<input type="checkbox"/>	<input type="checkbox"/>														
														TAWKH2110TG																
21.2	TAWNH2120T	<input type="checkbox"/>	<input type="checkbox"/>																											
	TAWKH2120TG																													
8	TAWLN2100S25	●	167.7	181.7	205.7	261.7	258.0	25	WS304518T	TKY10T	WPT4405	MK1KS	21.3	TAWNH2130T	<input type="checkbox"/>	<input type="checkbox"/>														
														TAWKH2130TG																
													21.4	TAWNH2140T	<input type="checkbox"/>	<input type="checkbox"/>														
														TAWKH2140TG																
													21.5 22.4	3	TAWSN2200S25	●	68.4	83.2	108.2	164.2	160.3	25	WS355520T	TKY15T	WPT4405	MK1KS	21.5	* TAWNH2150T	●	<input type="checkbox"/>
																												TAWKH2150TG		
21.6	TAWNH2160T	<input type="checkbox"/>	<input type="checkbox"/>																											
	TAWKH2160TG																													
21.7	TAWNH2170T	<input type="checkbox"/>	<input type="checkbox"/>																											
	TAWKH2170TG																													
21.8	TAWNH2180T	<input type="checkbox"/>	<input type="checkbox"/>																											
	TAWKH2180TG																													
5	TAWMN2200S25	●	111.4	128.2	148.2	204.2	200.3	25	WS355520T	TKY15T	WPT4405	MK1KS		21.9	TAWNH2190T	<input type="checkbox"/>	<input type="checkbox"/>													
															TAWKH2190TG															
														22.0	TAWNH2200T	●	<input type="checkbox"/>													
															TAWKH2200TG															
													22.1	TAWNH2210T	<input type="checkbox"/>	<input type="checkbox"/>														
														TAWKH2210TG																
22.2	TAWNH2220T	<input type="checkbox"/>	<input type="checkbox"/>																											
	TAWKH2220TG																													
8	TAWLN2200S25	●	175.9	189.9	213.9	269.9	266.0	25	WS355520T	TKY15T	WPT4405	MK1KS	22.3	TAWNH2230T	<input type="checkbox"/>	<input type="checkbox"/>														
														TAWKH2230TG																
													22.4	TAWNH2240T	<input type="checkbox"/>	<input type="checkbox"/>														
														TAWKH2240TG																
													22.5 23.4	3	TAWSN2300S25	●	71.6	86.4	108.4	164.4	160.3	25	WS355521T	TKY15T	WPT4405	MK1KS	22.5	* TAWNH2250T	●	<input type="checkbox"/>
																												TAWKH2250TG		
22.6	TAWNH2260T	<input type="checkbox"/>	<input type="checkbox"/>																											
	TAWKH2260TG																													
22.7	TAWNH2270T	<input type="checkbox"/>	<input type="checkbox"/>																											
	TAWKH2270TG																													
22.8	TAWNH2280T	<input type="checkbox"/>	<input type="checkbox"/>																											
	TAWKH2280TG																													
5	TAWMN2300S25	●	116.6	133.4	158.4	214.4	210.3	25	WS355521T	TKY15T	WPT4405	MK1KS		22.9	TAWNH2290T	<input type="checkbox"/>	<input type="checkbox"/>													
															TAWKH2290TG															
														23.0	TAWNH2300T	●	<input type="checkbox"/>													
															TAWKH2300TG															
													23.1	TAWNH2310T	<input type="checkbox"/>	<input type="checkbox"/>														
														TAWKH2310TG																
23.2	TAWNH2320T	<input type="checkbox"/>	<input type="checkbox"/>																											
	TAWKH2320TG																													
8	TAWLN2300S25	●	184.1	198.1	227.1	283.1	279.0	25	WS355521T	TKY15T	WPT4405	MK1KS	23.3	TAWNH2330T	<input type="checkbox"/>	<input type="checkbox"/>														
														TAWKH2330TG																
													23.4	TAWNH2340T	<input type="checkbox"/>	<input type="checkbox"/>														
														TAWKH2340TG																

OZNACZENIE PŁYTKI > M155

PARAMETRY SKRAWANIA > M157

UWAGI DOTYCZĄCE ZASTOSOWANIA > M158

CZĘŚCI ZAPASOWE > N001

INFORMACJE TECHNICZNE > P001

WIERCENIE (WIERTŁA Z PŁYTKĄ CENTRALNĄ)

TAW

WĘGLIKI
SPIEKANE

M
WIERCENIE

DC (mm)	Głębokość otworu (L/D)	Oprawka		Wymiary (mm)										Płytki			
		Numer zamówieniowy	Dostępność	LU	LBX	LH	OAL	LF	DCON					DC (mm)	Numer zamówieniowy	Dostępność	
														VP15TF	VP10H		
23.5 24.4	3	TAWSN2400S32	●	74.8	90.6	114.6	174.6	170.3	32	WS355521T	TKY15T	WPT4405	MK1KS	23.5	* TAWNH2350T	●	<input type="checkbox"/>
															TAWKH2350TG		
														23.6	TAWNH2360T	<input type="checkbox"/>	<input type="checkbox"/>
															TAWKH2360TG		
														23.7	TAWNH2370T	<input type="checkbox"/>	<input type="checkbox"/>
															TAWKH2370TG		
	5	TAWMN2400S32	●	121.8	139.6	164.6	224.6	220.3	32	WS355521T	TKY15T	WPT4405	MK1KS	23.8	TAWNH2380T	<input type="checkbox"/>	<input type="checkbox"/>
															TAWKH2380TG		
														23.9	TAWNH2390T	<input type="checkbox"/>	<input type="checkbox"/>
															TAWKH2390TG		
														24.0	TAWNH2400T	●	<input type="checkbox"/>
															TAWKH2400TG		
8	TAWLN2400S32	●	192.3	206.6	236.6	296.6	292.3	32	WS355521T	TKY15T	WPT4405	MK1KS	24.1	TAWNH2410T	<input type="checkbox"/>	<input type="checkbox"/>	
														TAWKH2410TG			
													24.2	TAWNH2420T	<input type="checkbox"/>	<input type="checkbox"/>	
														TAWKH2420TG			
													24.3	TAWNH2430T	<input type="checkbox"/>	<input type="checkbox"/>	
														TAWKH2430TG			
24.5 25.4	3	TAWSN2500S32	●	78.0	93.1	115.1	175.1	170.6	32	WS406023T	TKY25T	WPT4405	MK1KS	24.4	TAWNH2440T	<input type="checkbox"/>	<input type="checkbox"/>
															TAWKH2440TG		
														24.5	* TAWNH2450T	●	<input type="checkbox"/>
															TAWKH2450TG		
														24.6	TAWNH2460T	<input type="checkbox"/>	<input type="checkbox"/>
															TAWKH2460TG		
	5	TAWMN2500S32	●	127.0	145.1	170.1	230.1	225.6	32	WS406023T	TKY25T	WPT4405	MK1KS	24.7	TAWNH2470T	<input type="checkbox"/>	<input type="checkbox"/>
															TAWKH2470TG		
														24.8	TAWNH2480T	<input type="checkbox"/>	<input type="checkbox"/>
															TAWKH2480TG		
														24.9	TAWNH2490T	<input type="checkbox"/>	<input type="checkbox"/>
															TAWKH2490TG		
8	TAWLN2500S32	●	200.5	215.1	245.1	305.1	300.6	32	WS406023T	TKY25T	WPT4405	MK1KS	25.0	TAWNH2500T	●	<input type="checkbox"/>	
														TAWKH2500TG			
													25.1	TAWNH2510T	<input type="checkbox"/>	<input type="checkbox"/>	
														TAWKH2510TG			
													25.2	TAWNH2520T	<input type="checkbox"/>	<input type="checkbox"/>	
														TAWKH2520TG			
25.5 26.4	3	TAWSN2600S32	●	81.1	97.2	120.2	180.2	175.6	32	WS406024T	TKY25T	WPT4405	MK1KS	25.3	TAWNH2530T	<input type="checkbox"/>	<input type="checkbox"/>
															TAWKH2530TG		
														25.4	TAWNH2540T	<input type="checkbox"/>	<input type="checkbox"/>
															TAWKH2540TG		
														25.5	* TAWNH2550T	●	<input type="checkbox"/>
															TAWKH2550TG		
	5	TAWMN2600S32	●	132.1	151.2	175.2	235.2	230.6	32	WS406024T	TKY25T	WPT4405	MK1KS	25.6	TAWNH2560T	<input type="checkbox"/>	<input type="checkbox"/>
															TAWKH2560TG		
														25.7	TAWNH2570T	<input type="checkbox"/>	<input type="checkbox"/>
															TAWKH2570TG		
														25.8	TAWNH2580T	<input type="checkbox"/>	<input type="checkbox"/>
															TAWKH2580TG		
8	TAWLN2600S32	●	208.6	223.2	253.2	313.2	308.6	32	WS406024T	TKY25T	WPT4405	MK1KS	25.9	TAWNH2590T	<input type="checkbox"/>	<input type="checkbox"/>	
														TAWKH2590TG			
													26.0	TAWNH2600T	●	<input type="checkbox"/>	
														TAWKH2600TG			
													26.1	TAWNH2610T	<input type="checkbox"/>	<input type="checkbox"/>	
														TAWKH2610TG			
26.2	TAWLN2600S32	●	208.6	223.2	253.2	313.2	308.6	32	WS406024T	TKY25T	WPT4405	MK1KS	26.2	TAWNH2620T	<input type="checkbox"/>	<input type="checkbox"/>	
														TAWKH2620TG			
													26.3	TAWNH2630T	<input type="checkbox"/>	<input type="checkbox"/>	
														TAWKH2630TG			
26.4	TAWNH2640T	<input type="checkbox"/>	<input type="checkbox"/>														
	TAWKH2640TG																

Uwaga 1) Wymiary oznaczone (*) dotyczą wiertła z zamontowaną płytką.

Uwaga 2) Gdy geometria wiertła nie odpowiada wartościom podanym w tabeli (np. inna średnica i długość wiertła), prosimy o skontaktowanie się z naszą firmą.

● : Standard magazynowy. □ : Niestandardowy, produkowany na specjalne zamówienie.
(Uwaga: w opakowaniu znajduje się 1 płytki)

DC (mm)	Głębokość otworu (L/D)	Oprawka		Wymiary (mm)										Płytki			
		Numer zamówieniowy	Dostępność	LU	LBX	LH	OAL	LF	DCON					DC (mm)	Numer zamówieniowy	Dostępność	
																VP15TF	VP10H
26.5 27.4	3	TAWSN2700S32	●	84.3	99.4	120.4	180.4	175.6	32	WS406024T	TKY25T	WPT4405	MK1KS	26.5	* TAWNH2650T	●	<input type="checkbox"/>
															TAWKH2650TG		
														26.6	TAWNH2660T	<input type="checkbox"/>	<input type="checkbox"/>
															TAWKH2660TG		
														26.7	TAWNH2670T	<input type="checkbox"/>	<input type="checkbox"/>
															TAWKH2670TG		
	5	TAWMN2700S32	●	137.3	156.4	180.4	240.4	235.6	32	WS406024T	TKY25T	WPT4405	MK1KS	26.8	TAWNH2680T	<input type="checkbox"/>	<input type="checkbox"/>
															TAWKH2680TG		
														26.9	TAWNH2690T	<input type="checkbox"/>	<input type="checkbox"/>
															TAWKH2690TG		
														27.0	TAWNH2700T	●	<input type="checkbox"/>
															TAWKH2700TG		
8	TAWLN2700S32	●	216.8	231.4	261.4	321.4	316.6	32	WS406024T	TKY25T	WPT4405	MK1KS	27.1	TAWNH2710T	<input type="checkbox"/>	<input type="checkbox"/>	
														TAWKH2710TG			
													27.2	TAWNH2720T	<input type="checkbox"/>	<input type="checkbox"/>	
														TAWKH2720TG			
													27.3	TAWNH2730T	<input type="checkbox"/>	<input type="checkbox"/>	
														TAWKH2730TG			
27.5 28.4	3	TAWSN2800S32	●	87.5	102.2	125.2	185.2	180.2	32	WS508026T	TKY27T	WPT4405	MK1KS	27.4	TAWNH2740T	<input type="checkbox"/>	<input type="checkbox"/>
															TAWKH2740TG		
														27.5	* TAWNH2750T	●	<input type="checkbox"/>
															TAWKH2750TG		
														27.6	TAWNH2760T	<input type="checkbox"/>	<input type="checkbox"/>
															TAWKH2760TG		
	5	TAWMN2800S32	●	142.5	162.2	185.2	245.2	240.2	32	WS508026T	TKY27T	WPT4405	MK1KS	27.7	TAWNH2770T	<input type="checkbox"/>	<input type="checkbox"/>
															TAWKH2770TG		
														27.8	TAWNH2780T	<input type="checkbox"/>	<input type="checkbox"/>
															TAWKH2780TG		
														27.9	TAWNH2790T	<input type="checkbox"/>	<input type="checkbox"/>
															TAWKH2790TG		
8	TAWLN2800S32	●	225.0	239.2	269.2	329.2	324.2	32	WS508026T	TKY27T	WPT4405	MK1KS	28.0	TAWNH2800T	●	<input type="checkbox"/>	
														TAWKH2800TG			
													28.1	TAWNH2810T	<input type="checkbox"/>	<input type="checkbox"/>	
														TAWKH2810TG			
													28.2	TAWNH2820T	<input type="checkbox"/>	<input type="checkbox"/>	
														TAWKH2820TG			
28.5 29.4	3	TAWSN2900S32	●	90.7	105.4	130.4	190.4	185.2	32	WS508027T	TKY27T	WPT4405	MK1KS	28.3	TAWNH2830T	<input type="checkbox"/>	<input type="checkbox"/>
															TAWKH2830TG		
														28.4	TAWNH2840T	<input type="checkbox"/>	<input type="checkbox"/>
															TAWKH2840TG		
														28.5	* TAWNH2850T	●	<input type="checkbox"/>
															TAWKH2850TG		
	5	TAWMN2900S32	●	147.7	167.4	190.4	250.4	245.2	32	WS508027T	TKY27T	WPT4405	MK1KS	28.6	TAWNH2860T	<input type="checkbox"/>	<input type="checkbox"/>
															TAWKH2860TG		
														28.7	TAWNH2870T	<input type="checkbox"/>	<input type="checkbox"/>
															TAWKH2870TG		
														28.8	TAWNH2880T	<input type="checkbox"/>	<input type="checkbox"/>
															TAWKH2880TG		
8	TAWLN2900S32	●	233.2	247.4	277.4	337.4	332.2	32	WS508027T	TKY27T	WPT4405	MK1KS	28.9	TAWNH2890T	<input type="checkbox"/>	<input type="checkbox"/>	
														TAWKH2890TG			
													29.0	TAWNH2900T	●	<input type="checkbox"/>	
														TAWKH2900TG			
													29.1	TAWNH2910T	<input type="checkbox"/>	<input type="checkbox"/>	
														TAWKH2910TG			
														29.2	TAWNH2920T	<input type="checkbox"/>	<input type="checkbox"/>
															TAWKH2920TG		
														29.3	TAWNH2930T	<input type="checkbox"/>	<input type="checkbox"/>
															TAWKH2930TG		
														29.4	TAWNH2940T	<input type="checkbox"/>	<input type="checkbox"/>
															TAWKH2940TG		

OZNACZENIE PŁYTKI > M155
 PARAMETRY SKRAWANIA > M157
 UWAGI DOTYCZĄCE ZASTOSOWANIA > M158

CZĘŚCI ZAPASOWE > N001
 INFORMACJE TECHNICZNE > P001

WIERCENIE (WIERTŁA Z PŁYTKĄ CENTRALNĄ)

TAW

WĘGLIKI
SPIEKANE

M

WIERCENIE

DC (mm)	Głębokość otworu (L/D)	Oprawka		Wymiary (mm)										Płytki			
		Numer zamówieniowy	Dostępność	LU	LBX	LH	OAL	LF	DCON					DC (mm)	Numer zamówieniowy	Dostępność	
														VP15TF	VP10H		
29.5 30.4	3	TAWSN3000S32	●	93.9	109.6	130.6	190.6	185.2	32	WS508027T	TKY27T	WPT4405	MK1KS	29.5	* TAWNH2950T	●	<input type="checkbox"/>
															TAWKH2950TG		
														29.6	TAWNH2960T	<input type="checkbox"/>	<input type="checkbox"/>
															TAWKH2960TG		
														29.7	TAWNH2970T	<input type="checkbox"/>	<input type="checkbox"/>
															TAWKH2970TG		
	29.8	TAWNH2980T	<input type="checkbox"/>	<input type="checkbox"/>													
		TAWKH2980TG															
	29.9	TAWNH2990T	<input type="checkbox"/>	<input type="checkbox"/>													
		TAWKH2990TG															
	30.0	TAWNH3000T	●	<input type="checkbox"/>													
		TAWKH3000TG															
30.1	TAWNH3010T	<input type="checkbox"/>	<input type="checkbox"/>														
	TAWKH3010TG																
30.2	TAWNH3020T	<input type="checkbox"/>	<input type="checkbox"/>														
	TAWKH3020TG																
30.3	TAWNH3030T	<input type="checkbox"/>	<input type="checkbox"/>														
	TAWKH3030TG																
30.4	TAWNH3040T	<input type="checkbox"/>	<input type="checkbox"/>														
	TAWKH3040TG																

Uwaga 1) Wymiary oznaczone (*) dotyczą wiertła z zamontowaną płytką.

Uwaga 2) Gdy geometria wiertła nie odpowiada wartościom podanym w tabeli (np. inna średnica i długość wiertła), prosimy o skontaktowanie się z naszą firmą.

● : Standard magazynowy. □ : Niestandardowy, produkowany na specjalne zamówienie.

(Uwaga: w opakowaniu znajduje się 1 płytka)

PŁYTKI

Typ H

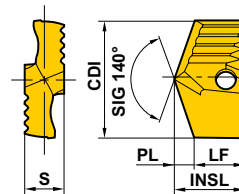
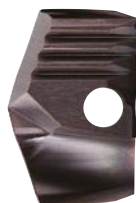

M

WIERCENIE

Numer zamówieniowy	Dostępność		Wymiary (mm)					Wiertło
	VP15TF	VP10H	CDI	INSL	LF	PL	S	
TAWNH1850T	●	□	18.5	12.7	9.3	3.4	7.0	TAWSN 1900S25
TAWNH1860T	●	□	18.6	12.7	9.3	3.4	7.0	
TAWNH1870T	●	□	18.7	12.7	9.3	3.4	7.0	
TAWNH1880T	●	□	18.8	12.7	9.3	3.4	7.0	
TAWNH1890T	●	□	18.9	12.7	9.3	3.4	7.0	
TAWNH1900T	●	□	19.0	12.7	9.2	3.5	7.0	
TAWNH1910T	●	□	19.1	12.7	9.2	3.5	7.0	
TAWNH1920T	●	□	19.2	12.7	9.2	3.5	7.0	
TAWNH1930T	●	□	19.3	12.7	9.2	3.5	7.0	
TAWNH1940T	●	□	19.4	12.7	9.2	3.5	7.0	
TAWNH1950T	●	□	19.5	12.6	9.1	3.5	7.0	TAWSN 2000S25
TAWNH1960T	●	□	19.6	12.7	9.1	3.6	7.0	
TAWNH1970T	●	□	19.7	12.7	9.1	3.6	7.0	
TAWNH1980T	●	□	19.8	12.7	9.1	3.6	7.0	
TAWNH1990T	●	□	19.9	12.7	9.1	3.6	7.0	
TAWNH2000T	●	□	20.0	12.6	9.0	3.6	7.0	
TAWNH2010T	□	□	20.1	12.7	9.0	3.7	7.0	
TAWNH2020T	□	□	20.2	12.7	9.0	3.7	7.0	
TAWNH2030T	□	□	20.3	12.7	9.0	3.7	7.0	
TAWNH2040T	□	□	20.4	12.7	9.0	3.7	7.0	
TAWNH2050T	●	□	20.5	12.6	8.9	3.7	7.0	TAWSN 2100S25
TAWNH2060T	□	□	20.6	12.6	8.9	3.7	7.0	
TAWNH2070T	□	□	20.7	12.7	8.9	3.8	7.0	
TAWNH2080T	□	□	20.8	12.7	8.9	3.8	7.0	
TAWNH2090T	□	□	20.9	12.7	8.9	3.8	7.0	
TAWNH2100T	●	□	21.0	12.6	8.8	3.8	7.0	
TAWNH2110T	□	□	21.1	12.6	8.8	3.8	7.0	
TAWNH2120T	□	□	21.2	12.7	8.8	3.9	7.0	
TAWNH2130T	□	□	21.3	12.7	8.8	3.9	7.0	
TAWNH2140T	□	□	21.4	12.7	8.8	3.9	7.0	
TAWNH2150T	●	□	21.5	14.5	10.6	3.9	8.0	TAWSN 2200S25
TAWNH2160T	□	□	21.6	14.5	10.6	3.9	8.0	
TAWNH2170T	□	□	21.7	14.5	10.6	3.9	8.0	
TAWNH2180T	□	□	21.8	14.6	10.6	4.0	8.0	
TAWNH2190T	□	□	21.9	14.6	10.6	4.0	8.0	
TAWNH2200T	●	□	22.0	14.5	10.5	4.0	8.0	
TAWNH2210T	□	□	22.1	14.5	10.5	4.0	8.0	
TAWNH2220T	□	□	22.2	14.5	10.5	4.0	8.0	
TAWNH2230T	□	□	22.3	14.6	10.5	4.1	8.0	
TAWNH2240T	□	□	22.4	14.6	10.5	4.1	8.0	

Numer zamówieniowy	Dostępność		Wymiary (mm)					Wiertło
	VP15TF	VP10H	CDI	INSL	LF	PL	S	
TAWNH2250T	●	□	22.5	14.5	10.4	4.1	8.0	TAWSN 2300S25
TAWNH2260T	□	□	22.6	14.5	10.4	4.1	8.0	
TAWNH2270T	□	□	22.7	14.5	10.4	4.1	8.0	
TAWNH2280T	□	□	22.8	14.5	10.4	4.1	8.0	
TAWNH2290T	□	□	22.9	14.6	10.4	4.2	8.0	
TAWNH2300T	●	□	23.0	14.5	10.3	4.2	8.0	
TAWNH2310T	□	□	23.1	14.5	10.3	4.2	8.0	
TAWNH2320T	□	□	23.2	14.5	10.3	4.2	8.0	
TAWNH2330T	□	□	23.3	14.5	10.3	4.2	8.0	
TAWNH2340T	□	□	23.4	14.6	10.3	4.3	8.0	
TAWNH2350T	●	□	23.5	14.5	10.2	4.3	8.0	TAWSN 2400S32
TAWNH2360T	□	□	23.6	14.5	10.2	4.3	8.0	
TAWNH2370T	□	□	23.7	14.5	10.2	4.3	8.0	
TAWNH2380T	□	□	23.8	14.5	10.2	4.3	8.0	
TAWNH2390T	□	□	23.9	14.5	10.2	4.3	8.0	
TAWNH2400T	●	□	24.0	14.5	10.1	4.4	8.0	
TAWNH2410T	□	□	24.1	14.5	10.1	4.4	8.0	
TAWNH2420T	□	□	24.2	14.5	10.1	4.4	8.0	
TAWNH2430T	□	□	24.3	14.5	10.1	4.4	8.0	
TAWNH2440T	□	□	24.4	14.5	10.1	4.4	8.0	
TAWNH2450T	●	□	24.5	16.2	11.7	4.5	9.0	TAWSN 2500S32
TAWNH2460T	□	□	24.6	16.2	11.7	4.5	9.0	
TAWNH2470T	□	□	24.7	16.2	11.7	4.5	9.0	
TAWNH2480T	□	□	24.8	16.2	11.7	4.5	9.0	
TAWNH2490T	□	□	24.9	16.2	11.7	4.5	9.0	
TAWNH2500T	●	□	25.0	16.1	11.6	4.5	9.0	
TAWNH2510T	□	□	25.1	16.2	11.6	4.6	9.0	
TAWNH2520T	□	□	25.2	16.2	11.6	4.6	9.0	
TAWNH2530T	□	□	25.3	16.2	11.6	4.6	9.0	
TAWNH2540T	□	□	25.4	16.2	11.6	4.6	9.0	
TAWNH2550T	●	□	25.5	16.1	11.5	4.6	9.0	TAWSN 2600S32
TAWNH2560T	□	□	25.6	16.2	11.5	4.7	9.0	
TAWNH2570T	□	□	25.7	16.2	11.5	4.7	9.0	
TAWNH2580T	□	□	25.8	16.2	11.5	4.7	9.0	
TAWNH2590T	□	□	25.9	16.2	11.5	4.7	9.0	
TAWNH2600T	●	□	26.0	16.1	11.4	4.7	9.0	
TAWNH2610T	□	□	26.1	16.1	11.4	4.7	9.0	
TAWNH2620T	□	□	26.2	16.2	11.4	4.8	9.0	
TAWNH2630T	□	□	26.3	16.2	11.4	4.8	9.0	
TAWNH2640T	□	□	26.4	16.2	11.4	4.8	9.0	

WIERCENIE (WIERTŁA Z PŁYTKĄ CENTRALNĄ)

TAW

WĘGLIKI
SPIEKANE

M

WIERCENIE

Numer zamówieniowy	Dostępność		Wymiary (mm)					Wiertło
	VP15TF	VP10H	CDI	INSL	LF	PL	S	
TAWNH2650T	●	□	26.5	16.1	11.3	4.8	9.0	TAWSN 2700S32
TAWNH2660T	□	□	26.6	16.1	11.3	4.8	9.0	
TAWNH2670T	□	□	26.7	16.2	11.3	4.9	9.0	
TAWNH2680T	□	□	26.8	16.2	11.3	4.9	9.0	
TAWNH2690T	□	□	26.9	16.2	11.3	4.9	9.0	
TAWNH2700T	●	□	27.0	16.1	11.2	4.9	9.0	
TAWNH2710T	□	□	27.1	16.1	11.2	4.9	9.0	
TAWNH2720T	□	□	27.2	16.1	11.2	4.9	9.0	
TAWNH2730T	□	□	27.3	16.2	11.2	5.0	9.0	
TAWNH2740T	□	□	27.4	16.2	11.2	5.0	9.0	
TAWNH2750T	●	□	27.5	17.3	12.3	5.0	10.0	TAWSN 2800S32
TAWNH2760T	□	□	27.6	17.3	12.3	5.0	10.0	
TAWNH2770T	□	□	27.7	17.3	12.3	5.0	10.0	
TAWNH2780T	□	□	27.8	17.4	12.3	5.1	10.0	
TAWNH2790T	□	□	27.9	17.4	12.3	5.1	10.0	
TAWNH2800T	●	□	28.0	17.3	12.2	5.1	10.0	
TAWNH2810T	□	□	28.1	17.3	12.2	5.1	10.0	
TAWNH2820T	□	□	28.2	17.3	12.2	5.1	10.0	
TAWNH2830T	□	□	28.3	17.4	12.2	5.2	10.0	
TAWNH2840T	□	□	28.4	17.4	12.2	5.2	10.0	

Numer zamówieniowy	Dostępność		Wymiary (mm)					Wiertło
	VP15TF	VP10H	CDI	INSL	LF	PL	S	
TAWNH2850T	●	□	28.5	17.3	12.1	5.2	10.0	TAWSN 2900S32
TAWNH2860T	□	□	28.6	17.3	12.1	5.2	10.0	
TAWNH2870T	□	□	28.7	17.3	12.1	5.2	10.0	
TAWNH2880T	□	□	28.8	17.3	12.1	5.2	10.0	
TAWNH2890T	□	□	28.9	17.4	12.1	5.3	10.0	
TAWNH2900T	●	□	29.0	17.3	12.0	5.3	10.0	
TAWNH2910T	□	□	29.1	17.3	12.0	5.3	10.0	
TAWNH2920T	□	□	29.2	17.3	12.0	5.3	10.0	
TAWNH2930T	□	□	29.3	17.3	12.0	5.3	10.0	
TAWNH2940T	□	□	29.4	17.4	12.0	5.4	10.0	
TAWNH2950T	●	□	29.5	17.3	11.9	5.4	10.0	TAWSN 3000S32
TAWNH2960T	□	□	29.6	17.3	11.9	5.4	10.0	
TAWNH2970T	□	□	29.7	17.3	11.9	5.4	10.0	
TAWNH2980T	□	□	29.8	17.3	11.9	5.4	10.0	
TAWNH2990T	□	□	29.9	17.3	11.9	5.4	10.0	
TAWNH3000T	●	□	30.0	17.3	11.8	5.5	10.0	
TAWNH3010T	□	□	30.1	17.3	11.8	5.5	10.0	
TAWNH3020T	□	□	30.2	17.3	11.8	5.5	10.0	
TAWNH3030T	□	□	30.3	17.3	11.8	5.5	10.0	
TAWNH3040T	□	□	30.4	17.3	11.8	5.5	10.0	

● : Standard magazynowy. □ : Niestandardowy, produkowany na specjalne zamówienie.

(Uwaga: w opakowaniu znajduje się 1 płytka)

PARAMETRY SKRAWANIA > M157

UWAGI DOTYCZĄCE ZASTOSOWANIA > M158

CZĘŚCI ZAPASOWE > N001

INFORMACJE TECHNICZNE > P001

ZALECANE PARAMETRY SKRAWANIA

Materiał przedmiotu obrabianego	Średnica wiertła Parametry Twardość	ϕ 18.5–ϕ 21.4		ϕ 21.5–ϕ 24.4	
		Prędkość skrawania (m/min)	Posuw (mm/obr.)	Prędkość skrawania (m/min)	Posuw (mm/obr.)
P Stal konstrukcyjna	≤180HB	90 (70–110)	0.25 (0.20–0.30)	100 (80–120)	0.30 (0.25–0.35)
	180–280HB	80 (60–100)	0.25 (0.20–0.30)	90 (70–110)	0.30 (0.25–0.35)
	280–350HB	70 (50–90)	0.20 (0.15–0.25)	80 (60–100)	0.25 (0.20–0.30)
M Stal nierdzewna	≤200HB	60 (50–70)	0.20 (0.15–0.22)	60 (50–70)	0.20 (0.15–0.22)
K Żeliwo	Wytrzymałość na rozciąganie ≤350MPa	120 (60–140)	0.25 (0.20–0.30)	130 (80–150)	0.35 (0.25–0.40)
	Żeliwo sferoidalne (GGG) Wytrzymałość na rozciąganie ≤450MPa	80 (60–90)	0.25 (0.20–0.30)	90 (60–100)	0.30 (0.25–0.35)

Materiał przedmiotu obrabianego	Średnica wiertła Parametry Twardość	ϕ 24.5–ϕ 27.4		ϕ 27.5–ϕ 30.4	
		Prędkość skrawania (m/min)	Posuw (mm/obr.)	Prędkość skrawania (m/min)	Posuw (mm/obr.)
P Stal konstrukcyjna	≤180HB	110 (80–120)	0.30 (0.25–0.35)	110 (80–120)	0.30 (0.25–0.35)
	180–280HB	100 (80–120)	0.30 (0.25–0.35)	100 (80–120)	0.30 (0.25–0.35)
	280–350HB	90 (70–110)	0.25 (0.20–0.30)	90 (70–110)	0.25 (0.20–0.30)
M Stal nierdzewna	≤200HB	70 (60–80)	0.25 (0.20–0.28)	70 (60–80)	0.25 (0.20–0.28)
K Żeliwo	Wytrzymałość na rozciąganie ≤350MPa	140 (90–160)	0.35 (0.25–0.40)	140 (90–160)	0.40 (0.30–0.45)
	Żeliwo sferoidalne (GGG) Wytrzymałość na rozciąganie ≤450MPa	100 (80–110)	0.30 (0.25–0.35)	100 (80–110)	0.30 (0.25–0.35)

Uwaga 1) Przy obróbce stali konstrukcyjnych i nierdzewnych zalecane jest zaszlifowanie typu H.

Uwaga 2) Użyć obrabiarki i metody zamocowania zapewniającej dużą sztywność. Przy obróbce stali nierdzewnych zastosować chłodzenie wewnętrzne. (nie stosować obróbki z minimalnym smarowaniem (MQL) ani chłodzenia mgłą olejową).

TAW

■ SZEROKOŚĆ ZASZLIFOWANIA

Jeżeli konieczne jest użycie płytki z zaszlifowaniem niestandardowym, przy zamawianiu prosimy o używanie następujących symboli.

(Zaszlifowania standardowe)

(Numer zamówieniowy płytki)

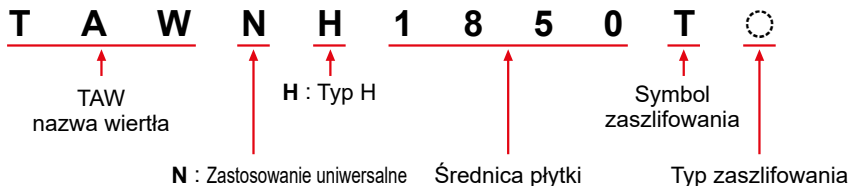

Typ zaszlifowania	Szerokość zaszlifowania (mm)
F	0
G	0.02–0.05
H	0.05–0.10
- (Standard)	0.10–0.15
S	0.20–0.25
M	0.25–0.30

UWAGI EKSPLOATACYJNE

■ MONTAŻ PŁYTKI

- Aby zamontować płytkę, odkręcić śrubę zaciskową. (Płytki typu H)
- Prawidłowo dopasować płytkę do ząbków w oprawce i docisnąć ją do dna.
- Przytrzymując delikatnie płytkę, jak pokazano na rysunku, dokręcić śrubę zaciskową za pomocą dostarczonego klucza dynamometrycznego. (Rys. 1)
- Sprawdzić, czy między dnem oprawki a płytką nie ma szczeliny. (Rys. 2)

Dokręcić śrubę zaciskową zachowując podany niżej moment.

Średnica wiertła	Moment dokręcenia
∅14–∅15	2.0N•m
∅16–∅18	2.0N•m
∅19–∅21	3.5N•m
∅22–∅24	5.5N•m
∅25–∅27	8.5N•m
∅28–∅30	12.0N•m

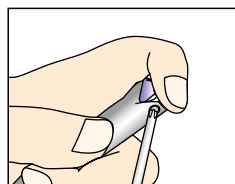

Rys. 1

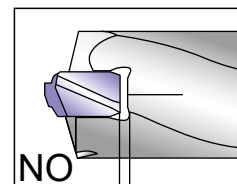
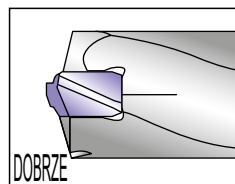

Rys. 2

Szczelina

WYMIANA PŁYTKI

- Przed zamontowaniem nowej płytki dokładnie oczyścić ząbki w oprawce. Większe zanieczyszczenia w ząbkach oprawki usunąć za pomocą dostarczonej płytki czyszczącej.

Notatki

A series of horizontal dashed lines for writing notes, spanning the width of the page.

WIERCENIE (WIERTŁA Z PŁYTKĄ CENTRALNĄ)

MVX

- Kombinacja płytki zewnętrznej pokrywanej metodą CVD i wewnętrznej pokrywanej metodą PVD.
- Sztynny korpus umożliwia obróbkę głębokich otworów L/D=6.



WĘGLIKI
SPIEKANE



WIERCENIE

M

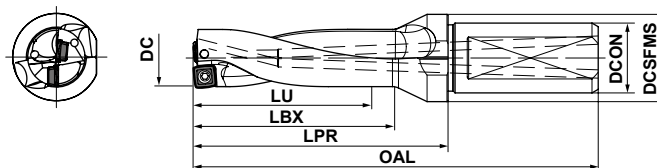

Maksymalny offset dla toczenia

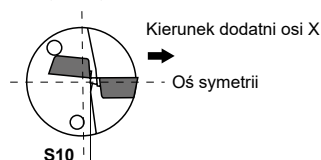

L/D	Tolerancja otworu (ok.) (mm)		
	ø14.0-ø33.0	ø33.5-ø47.0	ø48.0-ø63.0
2D, 3D	0 +0.25	0 +0.3	0 +0.3
4D, 5D	0 +0.35	0 +0.4	0 +0.45
6D	0 +0.45	0 +0.6	

DC (mm)	Głębokość otworu (L/D)	Numer zamówieniowy	Dostępność	Liczba płytek	Wymiary (mm)						S10 (mm)	Płytko	Wkręt dociskowy	F Typ klucza
					LU	LBX	LPR	OAL	DCON	DCSFMS				
NEW 14.0	2	MVX1400X2F20	●	2	28	35	50	93	20	25	0.6	SOX05	TPS20-1	TIP06F
	3	MVX1400X3F20	●	2	42	49	64	107	20	25	0.6	SOX05	TPS20-1	TIP06F
	4	MVX1400X4F20	●	2	56	63	78	121	20	25	0.6	SOX05	TPS20-1	TIP06F
	5	MVX1400X5F20	●	2	70	77	92	135	20	25	0.6	SOX05	TPS20-1	TIP06F
NEW 14.5	2	MVX1450X2F20	●	2	29	36	51	94	20	25	0.5	SOX05	TPS20-1	TIP06F
	3	MVX1450X3F20	●	2	43.5	50.5	65.5	108.5	20	25	0.5	SOX05	TPS20-1	TIP06F
	4	MVX1450X4F20	●	2	58	65	80	123	20	25	0.5	SOX05	TPS20-1	TIP06F
	5	MVX1450X5F20	●	2	72.5	79.5	94.5	137.5	20	25	0.5	SOX05	TPS20-1	TIP06F
NEW 15.0	2	MVX1500X2F20	●	2	30	37	52	95	20	25	0.35	SOX05	TPS20-1	TIP06F
	3	MVX1500X3F20	●	2	45	52	67	110	20	25	0.35	SOX05	TPS20-1	TIP06F
	4	MVX1500X4F20	●	2	60	67	82	125	20	25	0.35	SOX05	TPS20-1	TIP06F
	5	MVX1500X5F20	●	2	75	82	97	140	20	25	0.35	SOX05	TPS20-1	TIP06F
NEW 15.5	2	MVX1550X2F20	●	2	31	38	53	96	20	25	0.3	SOX05	TPS20-1	TIP06F
	3	MVX1550X3F20	●	2	46.5	53.5	68.5	111.5	20	25	0.3	SOX05	TPS20-1	TIP06F
	4	MVX1550X4F20	●	2	62	69	84	127	20	25	0.3	SOX05	TPS20-1	TIP06F
	5	MVX1550X5F20	●	2	77.5	84.5	99.5	142.5	20	25	0.3	SOX05	TPS20-1	TIP06F
NEW 16.0	2	MVX1600X2F20	●	2	32	39	54	97	20	25	0.25	SOX05	TPS20-1	TIP06F
	3	MVX1600X3F20	●	2	48	55	70	113	20	25	0.25	SOX05	TPS20-1	TIP06F
	4	MVX1600X4F20	●	2	64	71	86	129	20	25	0.25	SOX05	TPS20-1	TIP06F
	5	MVX1600X5F20	●	2	80	87	102	145	20	25	0.25	SOX05	TPS20-1	TIP06F
NEW 16.5	2	MVX1650X2F20	●	2	33	40	55	98	20	25	0.25	SOX05	TPS20-1	TIP06F
	3	MVX1650X3F20	●	2	49.5	56.5	71.5	114.5	20	25	0.25	SOX05	TPS20-1	TIP06F
	4	MVX1650X4F20	●	2	66	73	88	131	20	25	0.25	SOX05	TPS20-1	TIP06F
	5	MVX1650X5F20	●	2	82.5	89.5	104.5	147.5	20	25	0.25	SOX05	TPS20-1	TIP06F
17.0	2	MVX1700X2F20	●	2	34	41	56	99	20	25	0.5	SOX06	TPS25	TIP07F
	3	MVX1700X3F20	●	2	51	58	73	116	20	25	0.5	SOX06	TPS25	TIP07F
	4	MVX1700X4F20	●	2	68	75	90	133	20	25	0.5	SOX06	TPS25	TIP07F
	5	MVX1700X5F20	●	2	85	92	107	150	20	25	0.5	SOX06	TPS25	TIP07F
	6	MVX1700X6F20	●	2	102	109	124	167	20	25	0.5	SOX06	TPS25	TIP07F

* Moment dokręcenia (N · m) : TPS20-1=0.6, TPS25=1.0

● : Standard magazynowy.

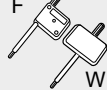
DC (mm)	Głębokość otworu (L/D)	Numer zamówieniowy	Dostępność	Liczba płytek	Wymiary (mm)						S10 (mm)	Płytko		
					LU	LBX	LPR	OAL	DCON	DCSFMS				
17.5	2	MVX1750X2F25	●	2	35	42	62	112	25	32	0.45	SOX06	TPS25	TIP07F
	3	MVX1750X3F25	●	2	52.5	59.5	79.5	129.5	25	32	0.45	SOX06	TPS25	TIP07F
	4	MVX1750X4F25	●	2	70	77	97	147	25	32	0.45	SOX06	TPS25	TIP07F
	5	MVX1750X5F25	●	2	87.5	94.5	114.5	164.5	25	32	0.45	SOX06	TPS25	TIP07F
	6	MVX1750X6F25	●	2	105	112	132	182	25	32	0.45	SOX06	TPS25	TIP07F
18.0	2	MVX1800X2F25	●	2	36	43	63	113	25	32	0.4	SOX06	TPS25	TIP07F
	3	MVX1800X3F25	●	2	54	61	81	131	25	32	0.4	SOX06	TPS25	TIP07F
	4	MVX1800X4F25	●	2	72	79	99	149	25	32	0.4	SOX06	TPS25	TIP07F
	5	MVX1800X5F25	●	2	90	97	117	167	25	32	0.4	SOX06	TPS25	TIP07F
	6	MVX1800X6F25	●	2	108	115	135	185	25	32	0.4	SOX06	TPS25	TIP07F
18.5	2	MVX1850X2F25	●	2	37	44	64	114	25	32	0.35	SOX06	TPS25	TIP07F
	3	MVX1850X3F25	●	2	55.5	62.5	82.5	132.5	25	32	0.35	SOX06	TPS25	TIP07F
	4	MVX1850X4F25	●	2	74	81	101	151	25	32	0.35	SOX06	TPS25	TIP07F
	5	MVX1850X5F25	●	2	92.5	99.5	119.5	169.5	25	32	0.35	SOX06	TPS25	TIP07F
	6	MVX1850X6F25	●	2	111	118	138	188	25	32	0.35	SOX06	TPS25	TIP07F
19.0	2	MVX1900X2F25	●	2	38	45	65	115	25	32	0.3	SOX06	TPS25	TIP07F
	3	MVX1900X3F25	●	2	57	64	84	134	25	32	0.3	SOX06	TPS25	TIP07F
	4	MVX1900X4F25	●	2	76	83	103	153	25	32	0.3	SOX06	TPS25	TIP07F
	5	MVX1900X5F25	●	2	95	102	122	172	25	32	0.3	SOX06	TPS25	TIP07F
	6	MVX1900X6F25	●	2	114	121	141	191	25	32	0.3	SOX06	TPS25	TIP07F
19.5	2	MVX1950X2F25	●	2	39	46	66	116	25	32	0.25	SOX06	TPS25	TIP07F
	3	MVX1950X3F25	●	2	58.5	65.5	85.5	135.5	25	32	0.25	SOX06	TPS25	TIP07F
	4	MVX1950X4F25	●	2	78	85	105	155	25	32	0.25	SOX06	TPS25	TIP07F
	5	MVX1950X5F25	●	2	97.5	104.5	124.5	174.5	25	32	0.25	SOX06	TPS25	TIP07F
	6	MVX1950X6F25	●	2	117	124	144	194	25	32	0.25	SOX06	TPS25	TIP07F
20.0	2	MVX2000X2F25	●	2	40	47	67	117	25	32	0.6	SOX07	TPS3	TIP10W
	3	MVX2000X3F25	●	2	60	67	87	137	25	32	0.6	SOX07	TPS3	TIP10W
	4	MVX2000X4F25	●	2	80	87	107	157	25	32	0.6	SOX07	TPS3	TIP10W
	5	MVX2000X5F25	●	2	100	107	127	177	25	32	0.6	SOX07	TPS3	TIP10W
	6	MVX2000X6F25	●	2	120	127	147	197	25	32	0.6	SOX07	TPS3	TIP10W
20.5	2	MVX2050X2F25	●	2	41	48	68	118	25	32	0.55	SOX07	TPS3	TIP10W
	3	MVX2050X3F25	●	2	61.5	68.5	88.5	138.5	25	32	0.55	SOX07	TPS3	TIP10W
21.0	2	MVX2100X2F25	●	2	42	49	69	119	25	32	0.5	SOX07	TPS3	TIP10W
	3	MVX2100X3F25	●	2	63	70	90	140	25	32	0.5	SOX07	TPS3	TIP10W
	4	MVX2100X4F25	●	2	84	91	111	161	25	32	0.5	SOX07	TPS3	TIP10W
	5	MVX2100X5F25	●	2	105	112	132	182	25	32	0.5	SOX07	TPS3	TIP10W
	6	MVX2100X6F25	●	2	126	133	153	203	25	32	0.5	SOX07	TPS3	TIP10W
21.5	2	MVX2150X2F25	●	2	43	50	70	120	25	32	0.45	SOX07	TPS3	TIP10W
	3	MVX2150X3F25	●	2	64.5	71.5	91.5	141.5	25	32	0.45	SOX07	TPS3	TIP10W
22.0	2	MVX2200X2F25	●	2	44	51	71	121	25	32	0.4	SOX07	TPS3	TIP10W
	3	MVX2200X3F25	●	2	66	73	93	143	25	32	0.4	SOX07	TPS3	TIP10W
	4	MVX2200X4F25	●	2	88	95	115	165	25	32	0.4	SOX07	TPS3	TIP10W
	5	MVX2200X5F25	●	2	110	117	137	187	25	32	0.4	SOX07	TPS3	TIP10W
	6	MVX2200X6F25	●	2	132	139	159	209	25	32	0.4	SOX07	TPS3	TIP10W
22.5	2	MVX2250X2F25	●	2	45	52	72	122	25	32	0.35	SOX07	TPS3	TIP10W
	3	MVX2250X3F25	●	2	67.5	74.5	94.5	144.5	25	32	0.35	SOX07	TPS3	TIP10W

* Moment dokręcenia (N • m) : TPS25=1.0, TPS3=2.0

OZNACZENIE PŁYTKI > M168
PARAMETRY SKRAWANIA > M169
TULEJA MIMOŚRODOWA > M172



UWAGI DOTYCZĄCE ZASTOSOWANIA > M173
CZĘŚCI ZAPASOWE > N001
INFORMACJE TECHNICZNE > P001

WIERCENIE (WIERTŁA Z PŁYTKĄ CENTRALNĄ)

MVX



WĘGLIKI
SPIEKANE

M
WIERCENIE

DC (mm)	Głębokość otworu (L/D)	Numer zamówieniowy	Dostępność	Liczba płytek	Wymiary (mm)						S10 (mm)	Płytko		
					LU	LBX	LPR	OAL	DCON	DCSFMS				
23.0	2	MVX2300X2F25	●	2	46	53	73	123	25	32	0.8	SOX08	TPS351	TIP10W
	3	MVX2300X3F25	●	2	69	76	96	146	25	32	0.8	SOX08	TPS351	TIP10W
	4	MVX2300X4F25	●	2	92	99	119	169	25	32	0.8	SOX08	TPS351	TIP10W
	5	MVX2300X5F25	●	2	115	122	142	192	25	32	0.8	SOX08	TPS351	TIP10W
	6	MVX2300X6F25	●	2	138	145	165	215	25	32	0.8	SOX08	TPS351	TIP10W
23.5	2	MVX2350X2F25	●	2	47	54	74	124	25	32	0.75	SOX08	TPS351	TIP10W
	3	MVX2350X3F25	●	2	70.5	77.5	97.5	147.5	25	32	0.75	SOX08	TPS351	TIP10W
24.0	2	MVX2400X2F25	●	2	48	55	75	125	25	32	0.7	SOX08	TPS351	TIP10W
	3	MVX2400X3F25	●	2	72	79	99	149	25	32	0.7	SOX08	TPS351	TIP10W
	4	MVX2400X4F25	●	2	96	103	123	173	25	32	0.7	SOX08	TPS351	TIP10W
	5	MVX2400X5F25	●	2	120	127	147	197	25	32	0.7	SOX08	TPS351	TIP10W
	6	MVX2400X6F25	●	2	144	151	171	221	25	32	0.7	SOX08	TPS351	TIP10W
24.5	2	MVX2450X2F25	●	2	49	56	76	126	25	32	0.65	SOX08	TPS351	TIP10W
	3	MVX2450X3F25	●	2	73.5	80.5	100.5	150.5	25	32	0.65	SOX08	TPS351	TIP10W
25.0	2	MVX2500X2F25	●	2	50	57	77	127	25	32	0.6	SOX08	TPS351	TIP10W
	3	MVX2500X3F25	●	2	75	82	102	152	25	32	0.6	SOX08	TPS351	TIP10W
	4	MVX2500X4F25	●	2	100	107	127	177	25	32	0.6	SOX08	TPS351	TIP10W
	5	MVX2500X5F25	●	2	125	132	152	202	25	32	0.6	SOX08	TPS351	TIP10W
	6	MVX2500X6F25	●	2	150	157	177	227	25	32	0.6	SOX08	TPS351	TIP10W
25.5	2	MVX2550X2F25	●	2	51	58	78	128	25	32	0.6	SOX08	TPS351	TIP10W
	3	MVX2550X3F25	●	2	76.5	83.5	103.5	153.5	25	32	0.6	SOX08	TPS351	TIP10W
26.0	2	MVX2600X2F32	●	2	52	59	79	134	32	42	0.5	SOX08	TPS351	TIP10W
	3	MVX2600X3F32	●	2	78	85	105	160	32	42	0.5	SOX08	TPS351	TIP10W
	4	MVX2600X4F32	●	2	104	111	131	186	32	42	0.5	SOX08	TPS351	TIP10W
	5	MVX2600X5F32	●	2	130	137	157	212	32	42	0.5	SOX08	TPS351	TIP10W
	6	MVX2600X6F32	●	2	156	163	183	238	32	42	0.5	SOX08	TPS351	TIP10W
26.5	2	MVX2650X2F32	●	2	53	60	80	135	32	42	0.5	SOX08	TPS351	TIP10W
	3	MVX2650X3F32	●	2	79.5	86.5	106.5	161.5	32	42	0.5	SOX08	TPS351	TIP10W
27.0	2	MVX2700X2F32	●	2	54	61	81	136	32	42	0.45	SOX08	TPS351	TIP10W
	3	MVX2700X3F32	●	2	81	88	108	163	32	42	0.45	SOX08	TPS351	TIP10W
	4	MVX2700X4F32	●	2	108	115	135	190	32	42	0.45	SOX08	TPS351	TIP10W
	5	MVX2700X5F32	●	2	135	142	162	217	32	42	0.45	SOX08	TPS351	TIP10W
	6	MVX2700X6F32	●	2	162	169	189	244	32	42	0.45	SOX08	TPS351	TIP10W
27.5	2	MVX2750X2F32	●	2	55	62	82	137	32	42	0.4	SOX08	TPS351	TIP10W
	3	MVX2750X3F32	●	2	82.5	89.5	109.5	164.5	32	42	0.4	SOX08	TPS351	TIP10W
28.0	2	MVX2800X2F32	●	2	56	63	83	138	32	42	0.85	SOX09	TPS4	TIP15W
	3	MVX2800X3F32	●	2	84	91	111	166	32	42	0.85	SOX09	TPS4	TIP15W
	4	MVX2800X4F32	●	2	112	119	139	194	32	42	0.85	SOX09	TPS4	TIP15W
	5	MVX2800X5F32	●	2	140	147	167	222	32	42	0.85	SOX09	TPS4	TIP15W
	6	MVX2800X6F32	●	2	168	175	195	250	32	42	0.85	SOX09	TPS4	TIP15W
28.5	2	MVX2850X2F32	●	2	57	64	84	139	32	42	0.8	SOX09	TPS4	TIP15W
	3	MVX2850X3F32	●	2	85.5	92.5	112.5	167.5	32	42	0.8	SOX09	TPS4	TIP15W
29.0	2	MVX2900X2F32	●	2	58	65	85	140	32	42	0.75	SOX09	TPS4	TIP15W
	3	MVX2900X3F32	●	2	87	94	114	169	32	42	0.75	SOX09	TPS4	TIP15W
	4	MVX2900X4F32	●	2	116	123	143	198	32	42	0.75	SOX09	TPS4	TIP15W
	5	MVX2900X5F32	●	2	145	152	172	227	32	42	0.75	SOX09	TPS4	TIP15W
	6	MVX2900X6F32	●	2	174	181	201	256	32	42	0.75	SOX09	TPS4	TIP15W
29.5	2	MVX2950X2F32	●	2	59	66	86	141	32	42	0.7	SOX09	TPS4	TIP15W
	3	MVX2950X3F32	●	2	88.5	95.5	115.5	170.5	32	42	0.7	SOX09	TPS4	TIP15W

* Moment dokręcenia (N • m) : TPS351=2.5, TPS4=3.5

● : Standard magazynowy.

DC (mm)	Głębokość otworu (L/D)	Numer zamówieniowy	Dostępność	Liczba płytek	Wymiary (mm)					S10 (mm)	Płytko		W 	
					LU	LBX	LPR	OAL	DCON					DCSFMS
30.0	2	MVX3000X2F32	●	2	60	67	87	142	32	42	0.65	SOX09	TPS4	TIP15W
	3	MVX3000X3F32	●	2	90	97	117	172	32	42	0.65	SOX09	TPS4	TIP15W
	4	MVX3000X4F32	●	2	120	127	147	202	32	42	0.65	SOX09	TPS4	TIP15W
	5	MVX3000X5F32	●	2	150	157	177	232	32	42	0.65	SOX09	TPS4	TIP15W
	6	MVX3000X6F32	●	2	180	187	207	262	32	42	0.65	SOX09	TPS4	TIP15W
30.5	3	MVX3050X3F32	●	2	91.5	98.5	118.5	173.5	32	42	0.6	SOX09	TPS4	TIP15W
31.0	2	MVX3100X2F32	●	2	62	69	89	144	32	42	0.55	SOX09	TPS4	TIP15W
	3	MVX3100X3F32	●	2	93	100	120	175	32	42	0.55	SOX09	TPS4	TIP15W
	4	MVX3100X4F32	●	2	124	131	151	206	32	42	0.55	SOX09	TPS4	TIP15W
	2	MVX3100X2F40	●	2	62	69	89	154	40	50	0.55	SOX09	TPS4	TIP15W
	3	MVX3100X3F40	●	2	93	100	120	185	40	50	0.55	SOX09	TPS4	TIP15W
	4	MVX3100X4F40	●	2	124	131	151	216	40	50	0.55	SOX09	TPS4	TIP15W
31.5	5	MVX3100X5F40	●	2	155	162	182	247	40	50	0.55	SOX09	TPS4	TIP15W
	6	MVX3100X6F40	●	2	186	193	213	278	40	50	0.55	SOX09	TPS4	TIP15W
32.0	3	MVX3150X3F40	●	2	94.5	101.5	121.5	186.5	40	50	0.55	SOX09	TPS4	TIP15W
32.0	2	MVX3200X2F32	●	2	64	71	91	146	32	42	0.45	SOX09	TPS4	TIP15W
	3	MVX3200X3F32	●	2	96	103	123	178	32	42	0.45	SOX09	TPS4	TIP15W
	4	MVX3200X4F32	●	2	128	135	155	210	32	42	0.45	SOX09	TPS4	TIP15W
	2	MVX3200X2F40	●	2	64	71	91	156	40	50	0.45	SOX09	TPS4	TIP15W
	3	MVX3200X3F40	●	2	96	103	123	188	40	50	0.45	SOX09	TPS4	TIP15W
	4	MVX3200X4F40	●	2	128	135	155	220	40	50	0.45	SOX09	TPS4	TIP15W
32.5	5	MVX3200X5F40	●	2	160	167	187	252	40	50	0.45	SOX09	TPS4	TIP15W
	6	MVX3200X6F40	●	2	192	199	219	284	40	50	0.45	SOX09	TPS4	TIP15W
33.0	3	MVX3250X3F40	●	2	97.5	104.5	124.5	189.5	40	50	0.45	SOX09	TPS4	TIP15W
33.0	2	MVX3300X2F32	●	2	66	73	93	148	32	42	0.4	SOX09	TPS4	TIP15W
	3	MVX3300X3F32	●	2	99	106	126	181	32	42	0.4	SOX09	TPS4	TIP15W
	4	MVX3300X4F32	●	2	132	139	159	214	32	42	0.4	SOX09	TPS4	TIP15W
	2	MVX3300X2F40	●	2	66	73	93	158	40	50	0.4	SOX09	TPS4	TIP15W
	3	MVX3300X3F40	●	2	99	106	126	191	40	50	0.4	SOX09	TPS4	TIP15W
	4	MVX3300X4F40	●	2	132	139	159	224	40	50	0.4	SOX09	TPS4	TIP15W
33.5	5	MVX3300X5F40	●	2	165	172	192	257	40	50	0.4	SOX09	TPS4	TIP15W
	6	MVX3300X6F40	●	2	198	205	225	290	40	50	0.4	SOX09	TPS4	TIP15W
34.0	3	MVX3350X3F40	●	2	100.5	107.5	127.5	192.5	40	50	1.15	SOX11	TPS43	TIP15W
34.0	2	MVX3400X2F40	●	2	68	75	105	170	40	50	1.11	SOX11	TPS43	TIP15W
	3	MVX3400X3F40	●	2	102	109	139	204	40	50	1.11	SOX11	TPS43	TIP15W
	4	MVX3400X4F40	●	2	136	143	173	238	40	50	1.11	SOX11	TPS43	TIP15W
	5	MVX3400X5F40	●	2	170	177	207	272	40	50	1.11	SOX11	TPS43	TIP15W
	6	MVX3400X6F40	●	2	204	211	241	306	40	50	1.1	SOX11	TPS43	TIP15W
34.5	3	MVX3450X3F40	●	2	103.5	110.5	140.5	205.5	40	50	1.08	SOX11	TPS43	TIP15W
35.0	2	MVX3500X2F40	●	2	70	77	107	172	40	50	1.03	SOX11	TPS43	TIP15W
	3	MVX3500X3F40	●	2	105	112	142	207	40	50	1.03	SOX11	TPS43	TIP15W
	4	MVX3500X4F40	●	2	140	147	177	242	40	50	1.03	SOX11	TPS43	TIP15W
	5	MVX3500X5F40	●	2	175	182	212	277	40	50	1.03	SOX11	TPS43	TIP15W
	6	MVX3500X6F40	●	2	210	217	247	312	40	50	1.02	SOX11	TPS43	TIP15W
35.5	3	MVX3550X3F40	●	2	106.5	113.5	143.5	208.5	40	50	0.99	SOX11	TPS43	TIP15W
36.0	2	MVX3600X2F40	●	2	72	79	109	174	40	50	0.95	SOX11	TPS43	TIP15W
	3	MVX3600X3F40	●	2	108	115	145	210	40	50	0.95	SOX11	TPS43	TIP15W
	4	MVX3600X4F40	●	2	144	151	181	246	40	50	0.95	SOX11	TPS43	TIP15W
	5	MVX3600X5F40	●	2	180	187	217	282	40	50	0.95	SOX11	TPS43	TIP15W
	6	MVX3600X6F40	●	2	216	223	253	318	40	50	0.94	SOX11	TPS43	TIP15W

* Moment dokręcenia (N • m) : TPS4=3.5, TPS43=3.5

OZNACZENIE PŁYTKI > M168
PARAMETRY SKRAWANIA > M169
TULEJA MIMOŚRODOWA > M172

UWAGI DOTYCZĄCE ZASTOSOWANIA > M173
CZĘŚCI ZAPASOWE > N001
INFORMACJE TECHNICZNE > P001



WIERCENIE (WIERTŁA Z PŁYTKĄ CENTRALNĄ)

MVX

WĘGLIKI
SPIEKANE



WIERCENIE

M

DC (mm)	Głębokość otworu (L/D)	Numer zamówieniowy	Dostępność	Liczba płytek	Wymiary (mm)						S10 (mm)	Płytko		
					LU	LBX	LPR	OAL	DCON	DCSFMS				
37.0	2	MVX3700X2F40	●	2	74	81	111	176	40	50	0.87	SOX11	TPS43	TIP15W
	3	MVX3700X3F40	●	2	111	118	148	213	40	50	0.87	SOX11	TPS43	TIP15W
	4	MVX3700X4F40	●	2	148	155	185	250	40	50	0.87	SOX11	TPS43	TIP15W
	5	MVX3700X5F40	●	2	185	192	222	287	40	50	0.87	SOX11	TPS43	TIP15W
	6	MVX3700X6F40	●	2	222	229	259	324	40	50	0.86	SOX11	TPS43	TIP15W
38.0	2	MVX3800X2F40	●	2	76	83	113	178	40	50	0.79	SOX11	TPS43	TIP15W
	3	MVX3800X3F40	●	2	114	121	151	216	40	50	0.79	SOX11	TPS43	TIP15W
	4	MVX3800X4F40	●	2	152	159	189	254	40	50	0.79	SOX11	TPS43	TIP15W
	5	MVX3800X5F40	●	2	190	197	227	292	40	50	0.79	SOX11	TPS43	TIP15W
	6	MVX3800X6F40	●	2	228	235	265	330	40	50	0.78	SOX11	TPS43	TIP15W
39.0	2	MVX3900X2F40	●	2	78	85	115	180	40	50	0.71	SOX11	TPS43	TIP15W
	3	MVX3900X3F40	●	2	117	124	154	219	40	50	0.71	SOX11	TPS43	TIP15W
	4	MVX3900X4F40	●	2	156	163	193	258	40	50	0.71	SOX11	TPS43	TIP15W
	5	MVX3900X5F40	●	2	195	202	232	297	40	50	0.71	SOX11	TPS43	TIP15W
	6	MVX3900X6F40	●	2	234	241	271	336	40	50	0.7	SOX11	TPS43	TIP15W
40.0	2	MVX4000X2F40	●	2	80	87	117	182	40	50	1.46	SOX13	TPS43	TIP15W
	3	MVX4000X3F40	●	2	120	127	157	222	40	50	1.46	SOX13	TPS43	TIP15W
	4	MVX4000X4F40	●	2	160	167	197	262	40	50	1.46	SOX13	TPS43	TIP15W
	5	MVX4000X5F40	●	2	200	207	237	302	40	50	1.46	SOX13	TPS43	TIP15W
	6	MVX4000X6F40	●	2	240	247	277	342	40	50	1.45	SOX13	TPS43	TIP15W
41.0	2	MVX4100X2F40	●	2	82	89	119	184	40	50	1.36	SOX13	TPS43	TIP15W
	3	MVX4100X3F40	●	2	123	130	160	225	40	50	1.36	SOX13	TPS43	TIP15W
	4	MVX4100X4F40	●	2	164	171	201	266	40	50	1.36	SOX13	TPS43	TIP15W
	5	MVX4100X5F40	●	2	205	212	242	307	40	50	1.36	SOX13	TPS43	TIP15W
	6	MVX4100X6F40	●	2	246	253	283	348	40	50	1.35	SOX13	TPS43	TIP15W
42.0	2	MVX4200X2F40	●	2	84	91	121	186	40	50	1.27	SOX13	TPS43	TIP15W
	3	MVX4200X3F40	●	2	126	133	163	228	40	50	1.27	SOX13	TPS43	TIP15W
	4	MVX4200X4F40	●	2	168	175	205	270	40	63	1.27	SOX13	TPS43	TIP15W
	5	MVX4200X5F40	●	2	210	217	247	312	40	63	1.27	SOX13	TPS43	TIP15W
	6	MVX4200X6F40	●	2	252	259	289	354	40	63	1.27	SOX13	TPS43	TIP15W
	4	MVX4200X4F50	★	2	168	175	205	280	50	63	1.27	SOX13	TPS43	TIP15W
	5	MVX4200X5F50	★	2	210	217	247	322	50	63	1.27	SOX13	TPS43	TIP15W
6	MVX4200X6F50	★	2	252	259	289	364	50	63	1.26	SOX13	TPS43	TIP15W	
43.0	2	MVX4300X2F40	●	2	86	93	123	188	40	50	1.18	SOX13	TPS43	TIP15W
	3	MVX4300X3F40	●	2	129	136	166	231	40	50	1.18	SOX13	TPS43	TIP15W
	4	MVX4300X4F40	●	2	172	179	209	274	40	63	1.18	SOX13	TPS43	TIP15W
	5	MVX4300X5F40	●	2	215	222	252	317	40	63	1.18	SOX13	TPS43	TIP15W
	6	MVX4300X6F40	●	2	258	265	295	360	40	63	1.17	SOX13	TPS43	TIP15W
	4	MVX4300X4F50	★	2	172	179	209	284	50	63	1.18	SOX13	TPS43	TIP15W
	5	MVX4300X5F50	★	2	215	222	252	327	50	63	1.18	SOX13	TPS43	TIP15W
6	MVX4300X6F50	★	2	258	265	295	370	50	63	1.17	SOX13	TPS43	TIP15W	
44.0	2	MVX4400X2F40	●	2	88	95	125	190	40	50	1.08	SOX13	TPS43	TIP15W
	3	MVX4400X3F40	●	2	132	139	169	234	40	50	1.08	SOX13	TPS43	TIP15W
	4	MVX4400X4F40	●	2	176	183	213	278	40	63	1.08	SOX13	TPS43	TIP15W
	5	MVX4400X5F40	●	2	220	227	257	322	40	63	1.08	SOX13	TPS43	TIP15W
	5	MVX4400X5F50	★	2	220	227	257	332	50	63	1.08	SOX13	TPS43	TIP15W

* Moment dokręcenia (N · m) : TPS43=3.5

● : Standard magazynowy. ★ : Na specjalne zamówienie z magazynu w Japonii.

DC (mm)	Głębokość otworu (L/D)	Numer zamówieniowy	Dostępność	Liczba płytek	Wymiary (mm)						S10 (mm)	Płytki		
					LU	LBX	LPR	OAL	DCON	DCSFMS				
45.0	2	MVX4500X2F40	●	2	90	97	127	192	40	50	0.99	SOX13	TPS43	TIP15W
	3	MVX4500X3F40	●	2	135	142	172	237	40	50	0.99	SOX13	TPS43	TIP15W
	4	MVX4500X4F40	●	2	180	187	217	282	40	63	0.99	SOX13	TPS43	TIP15W
	5	MVX4500X5F40	●	2	225	232	262	327	40	63	0.99	SOX13	TPS43	TIP15W
	4	MVX4500X4F50	★	2	180	187	217	292	50	63	0.99	SOX13	TPS43	TIP15W
	5	MVX4500X5F50	★	2	225	232	262	337	50	63	0.99	SOX13	TPS43	TIP15W
46.0	2	MVX4600X2F40	●	2	92	99	129	194	40	50	0.89	SOX13	TPS43	TIP15W
	3	MVX4600X3F40	●	2	138	145	175	240	40	50	0.89	SOX13	TPS43	TIP15W
	4	MVX4600X4F40	●	2	184	191	221	286	40	63	0.89	SOX13	TPS43	TIP15W
	5	MVX4600X5F40	●	2	230	237	267	332	40	63	0.89	SOX13	TPS43	TIP15W
	4	MVX4600X4F50	★	2	184	191	221	296	50	63	0.89	SOX13	TPS43	TIP15W
	5	MVX4600X5F50	★	2	230	237	267	342	50	63	0.89	SOX13	TPS43	TIP15W
47.0	2	MVX4700X2F40	●	2	94	101	141	206	40	63	1.9	SOX16	TPS54	TIP25D
	3	MVX4700X3F40	●	2	141	148	188	253	40	63	1.9	SOX16	TPS54	TIP25D
	4	MVX4700X4F40	●	2	188	195	235	300	40	63	1.9	SOX16	TPS54	TIP25D
	5	MVX4700X5F40	●	2	235	242	282	347	40	63	1.9	SOX16	TPS54	TIP25D
	4	MVX4700X4F50	★	2	188	195	235	310	50	63	1.9	SOX16	TPS54	TIP25D
	5	MVX4700X5F50	★	2	235	242	282	357	50	63	1.9	SOX16	TPS54	TIP25D
48.0	2	MVX4800X2F40	●	2	96	103	143	208	40	63	1.8	SOX16	TPS54	TIP25D
	3	MVX4800X3F40	●	2	144	151	191	256	40	63	1.8	SOX16	TPS54	TIP25D
	4	MVX4800X4F40	●	2	192	199	239	304	40	63	1.8	SOX16	TPS54	TIP25D
	5	MVX4800X5F40	●	2	240	247	287	352	40	63	1.8	SOX16	TPS54	TIP25D
	4	MVX4800X4F50	★	2	192	199	239	314	50	63	1.8	SOX16	TPS54	TIP25D
	5	MVX4800X5F50	★	2	240	247	287	362	50	63	1.8	SOX16	TPS54	TIP25D
49.0	2	MVX4900X2F40	●	2	98	105	145	210	40	63	1.7	SOX16	TPS54	TIP25D
	3	MVX4900X3F40	●	2	147	154	194	259	40	63	1.7	SOX16	TPS54	TIP25D
	4	MVX4900X4F40	●	2	196	203	243	308	40	63	1.7	SOX16	TPS54	TIP25D
	5	MVX4900X5F40	●	2	245	252	292	357	40	63	1.7	SOX16	TPS54	TIP25D
	4	MVX4900X4F50	★	2	196	203	243	318	50	63	1.7	SOX16	TPS54	TIP25D
	5	MVX4900X5F50	★	2	245	252	292	367	50	63	1.7	SOX16	TPS54	TIP25D
50.0	2	MVX5000X2F40	●	2	100	107	147	212	40	63	1.6	SOX16	TPS54	TIP25D
	3	MVX5000X3F40	●	2	150	157	197	262	40	63	1.6	SOX16	TPS54	TIP25D
	4	MVX5000X4F40	●	2	200	207	247	312	40	63	1.6	SOX16	TPS54	TIP25D
	5	MVX5000X5F40	●	2	250	257	297	362	40	63	1.6	SOX16	TPS54	TIP25D
	4	MVX5000X4F50	★	2	200	207	247	322	50	63	1.6	SOX16	TPS54	TIP25D
	5	MVX5000X5F50	★	2	250	257	297	372	50	63	1.6	SOX16	TPS54	TIP25D
51.0	2	MVX5100X2F40	●	2	102	109	149	214	40	63	1.5	SOX16	TPS54	TIP25D
	3	MVX5100X3F40	●	2	153	160	200	265	40	63	1.5	SOX16	TPS54	TIP25D
	4	MVX5100X4F40	●	2	204	211	251	316	40	63	1.5	SOX16	TPS54	TIP25D
	5	MVX5100X5F40	●	2	255	262	302	367	40	63	1.5	SOX16	TPS54	TIP25D
	4	MVX5100X4F50	★	2	204	211	251	326	50	63	1.5	SOX16	TPS54	TIP25D
	5	MVX5100X5F50	★	2	255	262	302	377	50	63	1.5	SOX16	TPS54	TIP25D
52.0	2	MVX5200X2F40	●	2	104	111	151	216	40	63	1.39	SOX16	TPS54	TIP25D
	3	MVX5200X3F40	●	2	156	163	203	268	40	63	1.39	SOX16	TPS54	TIP25D
	4	MVX5200X4F40	●	2	208	215	255	320	40	63	1.39	SOX16	TPS54	TIP25D
	5	MVX5200X5F40	●	2	260	267	307	372	40	63	1.39	SOX16	TPS54	TIP25D
	4	MVX5200X4F50	★	2	208	215	255	330	50	63	1.39	SOX16	TPS54	TIP25D
	5	MVX5200X5F50	★	2	260	267	307	382	50	63	1.39	SOX16	TPS54	TIP25D

* Moment dokręcenia (N • m) : TPS43=3.5, TPS54=7.5

OZNACZENIE PŁYTKI > M168
PARAMETRY SKRAWANIA > M169
TULEJA MIMOŚRODOWA > M172



UWAGI DOTYCZĄCE ZASTOSOWANIA > M173
CZĘŚCI ZAPASOWE > N001
INFORMACJE TECHNICZNE > P001

WIERCENIE (WIERTŁA Z PŁYTKĄ CENTRALNĄ)

MVX



WĘGLIKI
SPIEKANE

M
WIERCENIE

DC (mm)	Głębokość otworu (L/D)	Numer zamówieniowy	Dostępność	Liczba płytek	Wymiary (mm)						S10 (mm)	Płytki		
					LU	LBX	LPR	OAL	DCON	DCSFMS				
53.0	2	MVX5300X2F40	●	2	106	113	153	218	40	63	1.29	SOX16	TPS54	TIP25D
	3	MVX5300X3F40	●	2	159	166	206	271	40	63	1.29	SOX16	TPS54	TIP25D
	4	MVX5300X4F40	●	2	212	219	259	324	40	63	1.29	SOX16	TPS54	TIP25D
	5	MVX5300X5F40	●	2	265	272	312	377	40	63	1.29	SOX16	TPS54	TIP25D
	4	MVX5300X4F50	★	2	212	219	259	334	50	63	1.29	SOX16	TPS54	TIP25D
	5	MVX5300X5F50	★	2	265	272	312	387	50	63	1.29	SOX16	TPS54	TIP25D
54.0	2	MVX5400X2F40	●	2	108	115	155	220	40	63	1.19	SOX16	TPS54	TIP25D
	3	MVX5400X3F40	●	2	162	169	209	274	40	63	1.19	SOX16	TPS54	TIP25D
	4	MVX5400X4F40	●	2	216	223	263	328	40	63	1.19	SOX16	TPS54	TIP25D
	5	MVX5400X5F40	●	2	270	277	317	382	40	63	1.19	SOX16	TPS54	TIP25D
	4	MVX5400X4F50	★	2	216	223	263	338	50	63	1.19	SOX16	TPS54	TIP25D
	5	MVX5400X5F50	★	2	270	277	317	392	50	63	1.19	SOX16	TPS54	TIP25D
55.0	2	MVX5500X2F40	●	2	110	117	157	222	40	63	1.08	SOX16	TPS54	TIP25D
	3	MVX5500X3F40	●	2	165	172	212	277	40	63	1.08	SOX16	TPS54	TIP25D
	4	MVX5500X4F40	●	2	220	227	267	332	40	63	1.08	SOX16	TPS54	TIP25D
	5	MVX5500X5F40	●	2	275	282	322	387	40	63	1.08	SOX16	TPS54	TIP25D
	4	MVX5500X4F50	★	2	220	227	267	342	50	63	1.08	SOX16	TPS54	TIP25D
	5	MVX5500X5F50	●	2	275	282	322	397	50	63	1.08	SOX16	TPS54	TIP25D
56.0	2	MVX5600X2F40	●	2	112	119	159	224	40	63	0.98	SOX16	TPS54	TIP25D
	3	MVX5600X3F40	●	2	168	175	215	280	40	63	0.98	SOX16	TPS54	TIP25D
	4	MVX5600X4F40	●	2	224	231	271	336	40	63	0.98	SOX16	TPS54	TIP25D
	5	MVX5600X5F40	●	2	280	287	327	392	40	63	0.98	SOX16	TPS54	TIP25D
	4	MVX5600X4F50	★	2	224	231	271	346	50	63	0.98	SOX16	TPS54	TIP25D
	5	MVX5600X5F50	★	2	280	287	327	402	50	63	0.98	SOX16	TPS54	TIP25D
57.0	2	MVX5700X2F40	●	2	114	121	161	226	40	68	1.47	SOX18	TPS54	TIP25D
	3	MVX5700X3F40	●	2	171	178	218	283	40	68	1.47	SOX18	TPS54	TIP25D
	4	MVX5700X4F40	●	2	228	235	275	340	40	68	1.47	SOX18	TPS54	TIP25D
	5	MVX5700X5F40	●	2	285	292	332	397	40	68	1.47	SOX18	TPS54	TIP25D
	4	MVX5700X4F50	★	2	228	235	275	350	50	68	1.47	SOX18	TPS54	TIP25D
	5	MVX5700X5F50	★	2	285	292	332	407	50	68	1.47	SOX18	TPS54	TIP25D
58.0	2	MVX5800X2F40	●	2	116	123	163	228	40	68	1.37	SOX18	TPS54	TIP25D
	3	MVX5800X3F40	●	2	174	181	221	286	40	68	1.37	SOX18	TPS54	TIP25D
	4	MVX5800X4F40	●	2	232	239	279	344	40	68	1.37	SOX18	TPS54	TIP25D
	5	MVX5800X5F40	●	2	290	297	337	402	40	68	1.37	SOX18	TPS54	TIP25D
	4	MVX5800X4F50	★	2	232	239	279	354	50	68	1.37	SOX18	TPS54	TIP25D
	5	MVX5800X5F50	★	2	290	297	337	412	50	68	1.37	SOX18	TPS54	TIP25D
59.0	2	MVX5900X2F40	●	2	118	125	165	230	40	68	1.26	SOX18	TPS54	TIP25D
	3	MVX5900X3F40	●	2	177	184	224	289	40	68	1.26	SOX18	TPS54	TIP25D
	4	MVX5900X4F40	●	2	236	243	283	348	40	68	1.26	SOX18	TPS54	TIP25D
	5	MVX5900X5F40	●	2	295	302	342	407	40	68	1.26	SOX18	TPS54	TIP25D
	4	MVX5900X4F50	★	2	236	243	283	358	50	68	1.26	SOX18	TPS54	TIP25D
	5	MVX5900X5F50	★	2	295	302	342	417	50	68	1.26	SOX18	TPS54	TIP25D
60.0	2	MVX6000X2F40	●	2	120	127	167	232	40	68	1.16	SOX18	TPS54	TIP25D
	3	MVX6000X3F40	●	2	180	187	227	292	40	68	1.16	SOX18	TPS54	TIP25D
	4	MVX6000X4F40	●	2	240	247	287	352	40	68	1.16	SOX18	TPS54	TIP25D
	5	MVX6000X5F40	●	2	300	307	347	412	40	68	1.16	SOX18	TPS54	TIP25D
	4	MVX6000X4F50	★	2	240	247	287	362	50	68	1.16	SOX18	TPS54	TIP25D
	5	MVX6000X5F50	★	2	300	307	347	422	50	68	1.16	SOX18	TPS54	TIP25D

★ Moment dokręcenia (N • m) : TPS54=7.5

● : Standard magazynowy. ★ : Na specjalne zamówienie z magazynu w Japonii.

DC (mm)	Głębokość otworu (L/D)	Numer zamówieniowy	Dostępność	Liczba płytek	Wymiary (mm)						S10 (mm)	Płytki		D 
					LU	LBX	LPR	OAL	DCON	DCSFMS				
61.0	2	MVX6100X2F40	●	2	122	129	169	234	40	68	1.05	SOX18	TPS54	TIP25D
	3	MVX6100X3F40	●	2	183	190	230	295	40	68	1.05	SOX18	TPS54	TIP25D
	4	MVX6100X4F40	●	2	244	251	291	356	40	68	1.05	SOX18	TPS54	TIP25D
	5	MVX6100X5F40	●	2	305	312	352	417	40	68	1.05	SOX18	TPS54	TIP25D
	4	MVX6100X4F50	★	2	244	251	291	366	50	68	1.05	SOX18	TPS54	TIP25D
	5	MVX6100X5F50	★	2	305	312	352	427	50	68	1.05	SOX18	TPS54	TIP25D
62.0	2	MVX6200X2F40	●	2	124	131	171	236	40	68	0.95	SOX18	TPS54	TIP25D
	3	MVX6200X3F40	●	2	186	193	233	298	40	68	0.95	SOX18	TPS54	TIP25D
	4	MVX6200X4F40	●	2	248	255	295	360	40	68	0.95	SOX18	TPS54	TIP25D
	5	MVX6200X5F40	●	2	310	317	357	422	40	68	0.95	SOX18	TPS54	TIP25D
	4	MVX6200X4F50	★	2	248	255	295	370	50	68	0.95	SOX18	TPS54	TIP25D
	5	MVX6200X5F50	★	2	310	317	357	432	50	68	0.95	SOX18	TPS54	TIP25D
63.0	2	MVX6300X2F40	●	2	126	133	173	238	40	68	0.85	SOX18	TPS54	TIP25D
	3	MVX6300X3F40	●	2	189	196	236	301	40	68	0.85	SOX18	TPS54	TIP25D
	4	MVX6300X4F40	●	2	252	259	299	364	40	68	0.85	SOX18	TPS54	TIP25D
	5	MVX6300X5F40	●	2	315	322	362	427	40	68	0.85	SOX18	TPS54	TIP25D
	4	MVX6300X4F50	★	2	252	259	299	374	50	68	0.85	SOX18	TPS54	TIP25D
	5	MVX6300X5F50	★	2	315	322	362	437	50	68	0.85	SOX18	TPS54	TIP25D

* Moment dokręcenia (N • m) : TPS54=7.5

M









WIERCENIE

WIERCENIE (WIERTŁA Z PŁYTKĄ CENTRALNĄ)

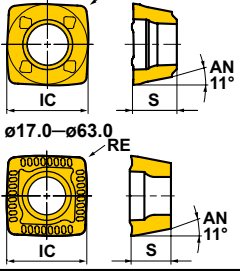
MVX

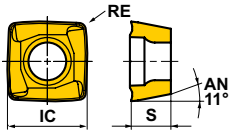

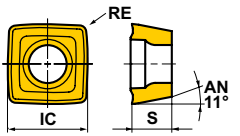

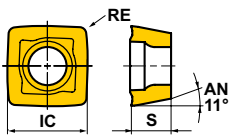







WĘGLIKI
SPIEKANE

PŁYTKI

Kształt	Średnica wiertła	Nr płytki	Wymiary (mm)			Pokrywany				Węglik spiekany		Geometria
			IC	S	RE	VP15TF	MC1020	MC5020	DP8020	TF15		
  Ogólnego przeznaczenia i jako płytka wewnętrzna lub zewnętrzna	UM	NEW SOMX052704-UM	5.0	2.7	0.4	●	●	●				
		SOMX063005-UM	6.0	3.0	0.5	●	●	●				
		SOMX073505-UM	7.0	3.5	0.5	●	●	●				
		SOMX084005-UM	8.3	4.0	0.5	●	●	●				
		SOMX094506-UM	9.7	4.5	0.6	●	●	●				
		SOMX115506-UM	11.6	5.5	0.6	●	●	●				
		SOMX136008-UM	13.8	6.0	0.8	●	●	●				
		SOMX166508-UM	16.5	6.5	0.8	●	●	●				
	SOMX187008-UM	18.2	7.0	0.8	●	●	●					
 Do obróbki stali nierdzewnych tylko płytka wewnętrzna	US	SOMX063005-US	6.0	3.0	0.5	●						
		SOMX073505-US	7.0	3.5	0.5	●						
		SOMX084005-US	8.0	4.0	0.5	●						
		SOMX094506-US	9.0	4.5	0.6	●						
		SOMX115506-US	11.6	5.5	0.6	●						
		SOMX136008-US	13.8	6.0	0.8	●						
		SOMX166508-US	16.5	6.5	0.8	●						
	SOMX187008-US	18.2	7.0	0.8	●							
 Wzmocniona krawędź skrawająca tylko płytka wewnętrzna	UH	SOMX062905-UH	6.0	2.9	0.5				●			
		SOMX073405-UH	7.0	3.4	0.5				●			
		SOMX083905-UH	8.3	3.9	0.5				●			
		SOMX094406-UH	9.7	4.4	0.6				●			
		SOMX115406-UH	11.6	5.4	0.6				●			
		SOMX135908-UH	13.8	5.9	0.8				●			
		SOMX166408-UH	16.5	6.4	0.8				●			
	SOMX186908-UH	18.2	6.9	0.8				●				
 Do stopów aluminium i jako płytka wewnętrzna lub zewnętrzna	UN	SOGX063005-UN	6.0	3.0	0.5					●		
		SOGX073505-UN	7.0	3.5	0.5					●		
		SOGX084005-UN	8.3	4.0	0.5					●		
		SOGX094506-UN	9.7	4.5	0.6					●		
		SOGX115506-UN	11.6	5.5	0.6					●		
		SOGX136008-UN	13.8	6.0	0.8					●		
		SOGX166508-UN	16.5	6.5	0.8					●		
	SOGX187008-UN	18.2	7.0	0.8					●			

Uwaga 1) Płytki w gatunku MC1020 i MC5020 są wykonane wyłącznie do użytku jako płytki zewnętrzne. Płytki w gatunku DP8020 są wykonane wyłącznie do użytku jako płytki wewnętrzne.

ZALECENIA DOTYCZĄCE DOBORU PŁYTEK

	Pierwszy wybór		W razie pęknięcia płytki zewnętrznej	
	Płytko zewnętrzna	Płytko wewnętrzna	Płytko zewnętrzna	Płytko wewnętrzna
P Stale węglowe, stopowe	MC1020 	VP15TF 	VP15TF 	VP15TF 
	Łamacz UM	Łamacz UM	Łamacz UM	Łamacz UM
M Stale nierdzewne	MC1020 	VP15TF 	VP15TF 	VP15TF 
	Łamacz UM	Łamacz US	Łamacz UM	Łamacz US
K Żeliwa	MC5020 	VP15TF 	VP15TF 	VP15TF 
	Łamacz UM	Łamacz UM	Łamacz UM	Łamacz UM

	Pierwszy wybór		W razie pęknięcia płytki zewnętrznej	
	Płytko zewnętrzna	Płytko wewnętrzna	Płytko zewnętrzna	Płytko wewnętrzna
H Stale hartowane	MC1020 	DP8020 	VP15TF 	DP8020 
	Łamacz UM	Łamacz UH	Łamacz UM	Łamacz UH
N Stopy aluminium	TF15 	TF15 		
	Łamacz UN	Łamacz UN		

ZALECANE PARAMETRY SKRAWANIA

Materiał obrabiany	Twardość	Vc (m/min)	Płytki wewnętrzna typ lamacza	φ14 – φ16.5				
				fr (mm/obr.)				
				L/D=2, 3	4	5		
P	Stal konstrukcyjna (C15, Ck15)	≤180HB	200 (180–235)	UM	0.05 (0.04–0.06)	0.05 (0.04–0.06)	0.05 (0.04–0.06)	
				UH	–	–	–	
	Stal węglowa, stal stopowa (Ck45, 41CrMo4)	180–280HB	140 (115–180)	UM	0.08 (0.06–0.14)	0.08 (0.06–0.09)	0.08 (0.06–0.09)	
				UH	–	–	–	
	Stal węglowa, stal stopowa (100Cr6)	280–350HB	100 (75–140)	UM	0.08 (0.06–0.14)	0.08 (0.06–0.09)	0.08 (0.06–0.09)	
				UH	–	–	–	
	Stal narzędziowa stopowa (X210Cr12)	≤350HB	135 (100–170)	UM	0.08 (0.06–0.14)	0.08 (0.06–0.09)	0.08 (0.06–0.09)	
				UH	–	–	–	
M	Stal nierdzewna austenityczna (X5CrNi18-10, X5CrNiMo17-12-2)	≤200HB	130 (80–180)	US	–	–	–	
				UM	0.06 (0.04–0.08)	0.05 (0.04–0.06)	0.05 (0.04–0.06)	
	Stal nierdzewna austenityczna (X2CrNi18-9, X5CrNiMoN17-11-2)	>200HB	130 (80–180)	US	–	–	–	
				UM	0.06 (0.04–0.08)	0.05 (0.04–0.06)	0.05 (0.04–0.06)	
	Stal nierdzewna ferrytyczna i martenzytyczna (X12Cr13, X6Cr17)	≤200HB	120 (80–165)	US	–	–	–	
				UM	0.06 (0.04–0.08)	0.05 (0.04–0.06)	0.05 (0.04–0.06)	
	Stal nierdzewna ferrytyczna i martenzytyczna (X17CrNi16-2, X30Cr13)	>200HB	120 (80–165)	US	–	–	–	
				UM	0.06 (0.04–0.08)	0.05 (0.04–0.06)	0.05 (0.04–0.06)	
	K	Żeliwo (GG25, GG30)	≤350MPa	160 (130–195)	UM	0.10 (0.06–0.14)	0.08 (0.06–0.10)	0.08 (0.06–0.10)
		Żeliwo sferoidalne (GG40)	≤450MPa	100 (80–135)	UM	0.10 (0.06–0.14)	0.08 (0.06–0.10)	0.08 (0.06–0.10)
Żeliwo sferoidalne (GGG70)		≤800HB	100 (70–125)	UM	0.08 (0.06–0.12)	0.07 (0.06–0.08)	0.07 (0.06–0.08)	
N	Stop aluminium (A6061, A7075)	Si<5%	200 (100-350)	UN	–	–	–	
	Stop aluminium (AC4B)	5%≤Si≤10%	150 (100-200)	UN	–	–	–	
	Stop aluminium (ADC12, A390)	Si>10%	150 (100-200)	UN	–	–	–	
H	Stale hartowane (X40CrMoV51, 55NiCrMoV6)	38 - 45HRC	50 (30-80)	UH	–	–	–	

Uwaga 1) Należy zmniejszyć prędkość skrawania o 30%, gdy stosowana jest płytka zewnętrzna VP15TF.

Uwaga 2) Przy stosowaniu wyłącznie chłodzenia zewnętrznego zalecany maksymalny wysięg wynosi L/D = 3.

Uwaga 3) Przy wierceniu stali nierdzewnej bardzo potrzebne są przelotowe kanały doprowadzenia chłodziwa.

UWAGI DOTYCZĄCE ZASTOSOWANIA > M173
CZĘŚCI ZAPASOWE > N001
INFORMACJE TECHNICZNE > P001

M

WIERCENIE

WIERCENIE (WIERTŁA Z PŁYTKĄ CENTRALNĄ)

MVX

WĘGLIKI
SPIEKANE

ZALECANE PARAMETRY SKRAWANIA

Materiał obrabiany	Twardość	Vc (m/min)	Płytki wewnętrzna typ lamacza	φ17–φ19.5					
				fr (mm/obr.)					
				L/D=2, 3	4	5	6		
P	Stal konstrukcyjna (C15, Ck15)	≤180HB	200 (180–235)	UM	0.05 (0.04–0.06)	0.05 (0.04–0.06)	0.05 (0.04–0.06)	0.04 (0.04–0.05)	
			UH						
	Stal węglowa, stal stopowa (Ck45, 41CrMo4)	180–280HB	140 (115–180)	UM	0.08 (0.06–0.14)	0.08 (0.06–0.09)	0.08 (0.06–0.09)	0.05 (0.04–0.06)	
				UH					
	Stal węglowa, stal stopowa (100Cr6)	280–350HB	100 (75–140)	UM	0.08 (0.06–0.14)	0.08 (0.06–0.09)	0.08 (0.06–0.09)	0.05 (0.04–0.06)	
				UH					
	Stal narzędziowa stopowa (X210Cr12)	≤350HB	135 (100–170)	UM	0.08 (0.06–0.14)	0.08 (0.06–0.09)	0.08 (0.06–0.09)	0.05 (0.04–0.06)	
				UH					
M	Stal nierdzewna austenityczna (X5CrNi18-10, X5CrNiMo17-12-2)	≤200HB	130 (80–180)	US	0.08 (0.06–0.12)	0.06 (0.04–0.08)	0.06 (0.04–0.08)	0.05 (0.04–0.06)	
			UM	0.06 (0.04–0.08)	0.05 (0.04–0.06)	0.05 (0.04–0.06)	0.04 (0.04–0.05)		
	Stal nierdzewna austenityczna (X2CrNiN18-9, X5CrNiMoN17-11-2)	>200HB	130 (80–180)	US	0.08 (0.06–0.12)	0.06 (0.04–0.08)	0.06 (0.04–0.08)	0.05 (0.04–0.06)	
				UM	0.06 (0.04–0.08)	0.05 (0.04–0.06)	0.05 (0.04–0.06)	0.04 (0.04–0.05)	
	Stal nierdzewna ferrytyczna i martenzytyczna (X12Cr13, X6Cr17)	≤200HB	120 (80–165)	US	0.08 (0.06–0.12)	0.06 (0.04–0.08)	0.06 (0.04–0.08)	0.05 (0.04–0.06)	
				UM	0.06 (0.04–0.08)	0.05 (0.04–0.06)	0.05 (0.04–0.06)	0.04 (0.04–0.05)	
	Stal nierdzewna ferrytyczna i martenzytyczna (X17CrNi16-2, X30Cr13)	>200HB	120 (80–165)	US	0.08 (0.06–0.12)	0.06 (0.04–0.08)	0.06 (0.04–0.08)	0.05 (0.04–0.06)	
				UM	0.06 (0.04–0.08)	0.05 (0.04–0.06)	0.05 (0.04–0.06)	0.04 (0.04–0.05)	
	K	Żeliwo (GG25, GG30)	≤350MPa	160 (130–195)	UM	0.11 (0.08–0.14)	0.09 (0.08–0.10)	0.09 (0.08–0.10)	0.05 (0.04–0.06)
		Żeliwo sferoidalne (GG40)	≤450MPa	100 (80–135)	UM	0.11 (0.08–0.14)	0.09 (0.08–0.10)	0.09 (0.08–0.10)	0.05 (0.04–0.06)
Żeliwo sferoidalne (GGG70)		≤800HB	100 (70–125)	UM	0.11 (0.08–0.14)	0.09 (0.08–0.10)	0.09 (0.08–0.10)	0.05 (0.04–0.06)	
N	Stop aluminium (A6061, A7075)	Si<5%	200 (100-350)	UN	0.12 (0.05–0.18)	0.12 (0.05–0.18)	0.12 (0.05–0.18)	0.08 (0.05–0.12)	
	Stop aluminium (AC4B)	5%≤Si≤10%	150 (100-200)	UN	0.12 (0.05–0.18)	0.12 (0.05–0.18)	0.12 (0.05–0.18)	0.08 (0.05–0.12)	
	Stop aluminium (ADC12, A390)	Si>10%	150 (100-200)	UN	0.12 (0.05–0.18)	0.12 (0.05–0.18)	0.12 (0.05–0.18)	0.08 (0.05–0.12)	
H	Stale hartowane (X40CrMoV51, 55NiCrMoV6)	38 - 45HRC	50 (30-80)	UH	0.08 (0.04–0.12)	0.06 (0.04–0.09)	–	–	

Uwaga 1) Należy zmniejszyć prędkość skrawania o 30%, gdy stosowana jest płytka zewnętrzna VP15TF.

Uwaga 2) Przy stosowaniu wyłącznie chłodzenia zewnętrznego zalecany maksymalny wysięg wynosi L/D = 3.

Uwaga 3) Przy wierceniu stali nierdzewnej bardzo potrzebne są przelotowe kanały doprowadzenia chłodziwa.

	φ20—φ23.5				φ24—φ29.5				φ30—φ63			
	fr (mm/obr.)				fr (mm/obr.)				fr (mm/obr.)			
	L/D=2, 3	4	5	6	L/D=2, 3	4	5	6	L/D=2, 3	4	5	6
	0.06 (0.04—0.08)	0.06 (0.04—0.07)	0.06 (0.04—0.07)	0.04 (0.04—0.05)	0.07 (0.04—0.08)	0.06 (0.04—0.07)	0.06 (0.04—0.07)	0.05 (0.04—0.06)	0.08 (0.06—0.10)	0.07 (0.06—0.08)	0.07 (0.06—0.08)	0.06 (0.06—0.07)
	0.10 (0.06—0.18)	0.09 (0.06—0.12)	0.09 (0.06—0.12)	0.07 (0.06—0.08)	0.12 (0.08—0.18)	0.10 (0.08—0.12)	0.10 (0.08—0.12)	0.09 (0.08—0.10)	0.14 (0.08—0.20)	0.12 (0.08—0.16)	0.12 (0.08—0.16)	0.11 (0.10—0.12)
	0.10 (0.06—0.18)	0.09 (0.06—0.12)	0.09 (0.06—0.12)	0.07 (0.06—0.08)	0.12 (0.08—0.18)	0.10 (0.08—0.12)	0.10 (0.08—0.12)	0.09 (0.08—0.10)	0.14 (0.08—0.20)	0.12 (0.08—0.16)	0.12 (0.08—0.16)	0.11 (0.10—0.12)
	0.10 (0.06—0.18)	0.09 (0.06—0.12)	0.09 (0.06—0.12)	0.07 (0.06—0.08)	0.12 (0.08—0.18)	0.10 (0.08—0.12)	0.10 (0.08—0.12)	0.09 (0.08—0.10)	0.14 (0.08—0.20)	0.12 (0.08—0.16)	0.12 (0.08—0.16)	0.10 (0.08—0.12)
	0.10 (0.06—0.14)	0.07 (0.06—0.08)	0.07 (0.06—0.08)	0.06 (0.06—0.07)	0.10 (0.06—0.14)	0.08 (0.06—0.10)	0.08 (0.06—0.10)	0.07 (0.06—0.08)	0.10 (0.06—0.14)	0.09 (0.06—0.12)	0.09 (0.06—0.12)	0.07 (0.06—0.10)
	0.08 (0.06—0.12)	0.07 (0.06—0.08)	0.07 (0.06—0.08)	0.06 (0.06—0.07)	0.09 (0.06—0.12)	0.07 (0.06—0.09)	0.07 (0.06—0.09)	0.06 (0.06—0.08)	0.09 (0.06—0.12)	0.08 (0.06—0.10)	0.08 (0.06—0.10)	0.07 (0.06—0.08)
	0.10 (0.06—0.14)	0.07 (0.06—0.08)	0.07 (0.06—0.08)	0.06 (0.06—0.07)	0.10 (0.06—0.14)	0.08 (0.06—0.10)	0.08 (0.06—0.10)	0.07 (0.06—0.08)	0.10 (0.06—0.14)	0.09 (0.06—0.12)	0.09 (0.06—0.12)	0.07 (0.06—0.10)
	0.08 (0.06—0.12)	0.07 (0.06—0.08)	0.07 (0.06—0.08)	0.06 (0.06—0.07)	0.09 (0.06—0.12)	0.07 (0.06—0.09)	0.07 (0.06—0.09)	0.06 (0.06—0.08)	0.09 (0.06—0.12)	0.08 (0.06—0.10)	0.08 (0.06—0.10)	0.07 (0.06—0.08)
	0.10 (0.06—0.14)	0.07 (0.06—0.08)	0.07 (0.06—0.08)	0.06 (0.06—0.07)	0.10 (0.06—0.14)	0.08 (0.06—0.10)	0.08 (0.06—0.10)	0.07 (0.06—0.08)	0.10 (0.06—0.14)	0.09 (0.06—0.12)	0.09 (0.06—0.12)	0.07 (0.06—0.10)
	0.08 (0.06—0.12)	0.07 (0.06—0.08)	0.07 (0.06—0.08)	0.06 (0.06—0.07)	0.09 (0.06—0.12)	0.07 (0.06—0.09)	0.07 (0.06—0.09)	0.06 (0.06—0.08)	0.09 (0.06—0.12)	0.08 (0.06—0.10)	0.08 (0.06—0.10)	0.07 (0.06—0.08)
	0.14 (0.10—0.18)	0.10 (0.10—0.12)	0.10 (0.10—0.12)	0.07 (0.06—0.08)	0.15 (0.10—0.20)	0.11 (0.10—0.13)	0.11 (0.10—0.13)	0.09 (0.08—0.10)	0.15 (0.10—0.20)	0.12 (0.10—0.13)	0.12 (0.10—0.13)	0.11 (0.10—0.12)
	0.13 (0.10—0.16)	0.10 (0.10—0.11)	0.10 (0.10—0.11)	0.07 (0.06—0.08)	0.14 (0.10—0.18)	0.11 (0.10—0.12)	0.11 (0.10—0.12)	0.09 (0.08—0.10)	0.15 (0.10—0.20)	0.12 (0.10—0.13)	0.12 (0.10—0.13)	0.11 (0.10—0.12)
	0.13 (0.10—0.16)	0.10 (0.10—0.11)	0.10 (0.10—0.11)	0.07 (0.06—0.08)	0.14 (0.10—0.18)	0.11 (0.10—0.12)	0.11 (0.10—0.12)	0.09 (0.08—0.10)	0.15 (0.10—0.20)	0.12 (0.10—0.13)	0.12 (0.10—0.13)	0.11 (0.10—0.12)
	0.12 (0.05—0.18)	0.12 (0.05—0.18)	0.12 (0.05—0.18)	0.08 (0.05—0.12)	0.12 (0.05—0.18)	0.12 (0.05—0.18)	0.12 (0.05—0.18)	0.08 (0.05—0.12)	0.12 (0.05—0.20)	0.12 (0.05—0.18)	0.12 (0.05—0.18)	0.08 (0.05—0.12)
	0.12 (0.05—0.18)	0.12 (0.05—0.18)	0.12 (0.05—0.18)	0.08 (0.05—0.12)	0.12 (0.05—0.18)	0.12 (0.05—0.18)	0.12 (0.05—0.18)	0.08 (0.05—0.12)	0.12 (0.05—0.20)	0.12 (0.05—0.18)	0.12 (0.05—0.18)	0.08 (0.05—0.12)
	0.12 (0.05—0.18)	0.12 (0.05—0.18)	0.12 (0.05—0.18)	0.08 (0.05—0.12)	0.12 (0.05—0.18)	0.12 (0.05—0.18)	0.12 (0.05—0.18)	0.08 (0.05—0.12)	0.12 (0.05—0.20)	0.12 (0.05—0.18)	0.12 (0.05—0.18)	0.08 (0.05—0.12)
	0.09 (0.06—0.14)	0.07 (0.06—0.09)	—	—	0.09 (0.06—0.14)	0.07 (0.06—0.09)	—	—	0.11 (0.06—0.16)	0.09 (0.06—0.12)	—	—

TULEJA MIMOŚRODOWA [JFS]

- Tuleja rozszerzająca zakres zastosowań wiertel typu MVX, umożliwiającą zwiększanie średnicy wiercenia co 0.1mm

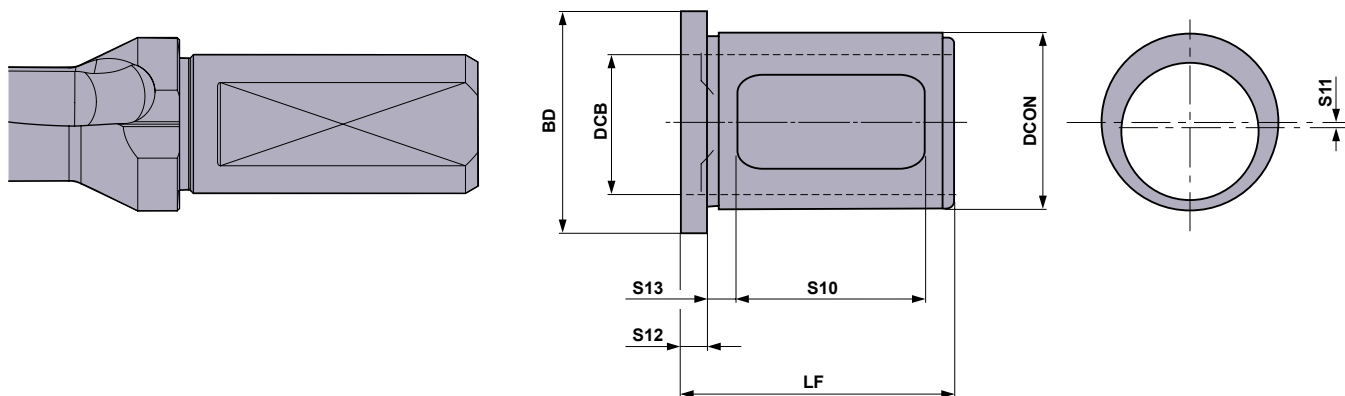

M
WIERCENIE

Numer zamówieniowy zestawu	Numer zamówieniowy pojedynczej tulei	Dostępność	Wymiary (mm)							★Wzrost (S11×2)	Typ zalecanego wiertła MVX
			BD	DCON	DCB	LF	S10	S12	S13		
JFS-1	JFS2520-10	●	33	25	20	43	30	5	5	0.1	MVX1700 X ØF20
	JFS2520-20	●	33	25	20	43	30	5	5	0.2	
	JFS2520-30	●	33	25	20	43	30	5	5	0.3	
	JFS2520-40	●	33	25	20	43	30	5	5	0.4	
	JFS2520-50	●	33	25	20	43	30	5	5	0.5	
JFS-2	JFS3225-10	●	40	32	25	50	34	5	5	0.1	MVX1750 X ØF25 MVX2550 X ØF25
	JFS3225-20	●	40	32	25	50	34	5	5	0.2	
	JFS3225-30	●	40	32	25	50	34	5	5	0.3	
	JFS3225-40	●	40	32	25	50	34	5	5	0.4	
	JFS3225-50	●	40	32	25	50	34	5	5	0.5	
JFS-3	JFS4032-10	●	48	40	32	55	40	5	5	0.1	MVX2600 X ØF32 MVX3000 X ØF32
	JFS4032-20	●	48	40	32	55	40	5	5	0.2	
	JFS4032-30	●	48	40	32	55	40	5	5	0.3	
	JFS4032-40	●	48	40	32	55	40	5	5	0.4	
	JFS4032-50	●	48	40	32	55	40	5	5	0.5	
JFS-4	JFS5040-10	★	68	50	40	65	50	5	5	0.1	MVX3100 X ØF40 MVX6300 X ØF40
	JFS5040-20	★	68	50	40	65	50	5	5	0.2	
	JFS5040-30	★	68	50	40	65	50	5	5	0.3	
	JFS5040-40	★	68	50	40	65	50	5	5	0.4	
	JFS5040-50	★	68	50	40	65	50	5	5	0.5	

Nie pasuje do chwytu o średnicy ø50mm.

★ Wzrost : wielkość, o jaką wzrasta średnica wiercenia.

WSKAZÓWKI DOBORU TULEI MIMOŚRODOWEJ

Żądana średnica = (ø wiertła+ wymiar tulei JFS) + 0.1mm

(Przykład) Żądana średnica wynosi 20.3mm (przyjęto nadwymiar 0.1mm).

$$\phi 20.3 = (\text{MVX2000 X } \phi F25 + \text{JFS3225-20}) + 0.1$$

↓
Wiertło o średnicy 20mm Przyjęto Wzrost spowodowany zastosowaniem tulei 0.2mm. Nadwymiar

<Wybrane wiertło>
Wiertła typu Drill
: MVX2000 X ØF25
Tuleja mimośrodowa jfs [JFS]
: JFS3225-20

Uwaga 1) Wielkość nadwymiaru może ulegać zmianom w zależności od parametrów skrawania; prosimy traktować powyższą wartość jako orientacyjną.

ZAMAWIANIE TULEI MIMOŚRODOWEJ

Metoda 1

Nadwymiar może zależeć od parametrów skrawania. Dlatego zaleca się nabycie całego zestawu. Składając zamówienie, podawać oznaczenie zestawu. (5 tulei/ zestaw)

Metoda 2

Można zamawiać tuleje pojedynczo. Składając zamówienie, podawać oznaczenie konkretnej tulei.

● : Standard magazynowy. ★ : Na specjalne zamówienie z magazynu w Japonii.

■ SPOSÓB ZASTOSOWANIA TULEI MIMOŚRODOWEJ

1. Montując wiertło w tulei mimośrodowej, należy umieścić w jednej linii rowek klinowy znajdujący się na obwodzie kołnierza wiertła i nacięcie znajdujące się na tulei mimośrodowej. Jeśli wiertło nie ma naciętego rowka klinowego, należy ustawić w jednej linii spłaszczenie znajdujące się na chwycie wiertła z otworem znajdującym się w tulei.

2. Aby zamocować wiertło, wsadzić śruby A oprawki bezpośrednio w otwór w tulei. Dokręcić śrubę B tylko na tyle, aby nie uszkodzić tulei.

(Uwaga)

- Nie ma możliwości wykonywania dokładnej regulacji średnicy tulei.
- Nie można jej używać z oprawkami z tuleją zaciskową.

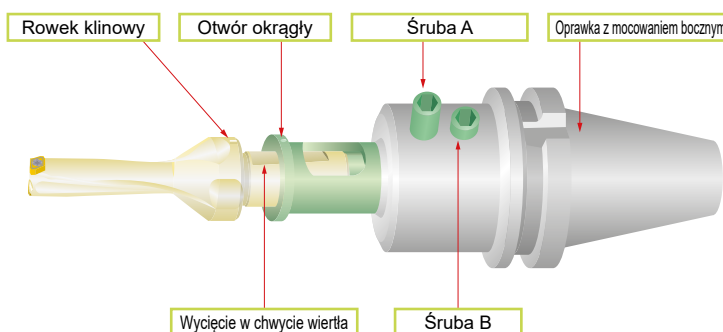

■ STOSOWANIE WIERTŁA TYPU MVX

● Stosowanie w tokarce

(1) Płytkę zewnętrzną i oś X maszyny muszą być równoległe. Wiertło jest zaprojektowane tak, aby po dopasowaniu osi wiertła i wrzeciona maszyny, środek płytki wewnętrznej znajdował się o 0-0,15 mm poniżej osi wrzeciona.

*Płytkę wewnętrzną może pęknąć, jeśli jej środek znajduje się wyżej niż oś X maszyny.

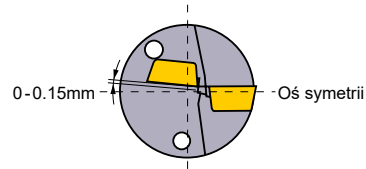

(2) Aby ustawić średnicę otworu przez przesunięcie wiertła, należy przesuwać wiertło w kierunku dodatnim osi X (kierunek zwiększania średnicy otworu). Wartość maksymalnej dopuszczalnej wielkości wyrównania dla każdego uchwytu znajduje się w zestawieniu wymiarów uchwytu.

*Nie zaleca się regulacji osi X w kierunku ujemnym (kierunek zmniejszania średnicy otworu), ponieważ może dojść do zasłonięcia otworu przez uchwyt.

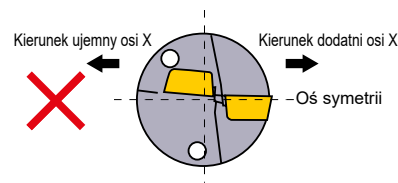

(3) Przy wierceniu otworów przelotowych na tokarce, krążek wytworzony przez wychodzące z elementu obrabianego wiertło może zostać wyrzucony z dużą prędkością. Aby ograniczyć niebezpieczeństwo odniesienia obrażeń ciała lub uszkodzenia mienia, zalecamy stosowanie osłony.

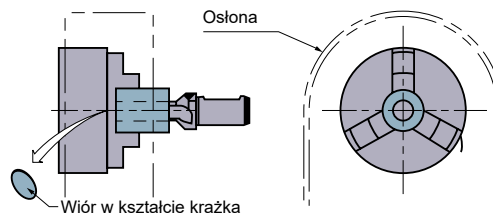



DC<2

DC≥2

Stal
szybkotnąca

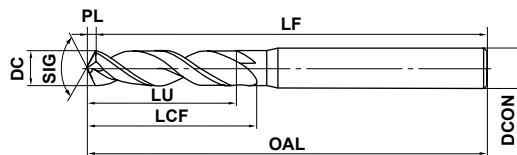

*LU = LCF-2DC (Maks. 3×DC)



0.5≤DC≤3	3<DC≤6	6<DC≤10	10<DC≤13
0 -0.014	0 -0.018	0 -0.022	0 -0.027

* Tolerancja wszystkich wiertel za wyjątkiem wiertel stopniowanych co 0.1mm oraz wiertel o średnicy poniżej 2.0mm wynosi 0-0.009mm.

WIERCENIE

M

● Dzięki opracowaniu nowej powłoki Violet, osiągnięto dużą wydajność wiercenia oraz długą żywotność narzędzia.

DC (mm)	Numer zamówieniowy	Wymiary (mm)					Dostępność
		LCF	OAL	LF	PL	DCON	
0.50	VAPDSD0050	3.2	50.2	50	0.15	3	●
0.51	VAPDSD0051	3.2	50.2	50	0.15	3	★
0.52	VAPDSD0052	3.2	50.2	50	0.16	3	★
0.53	VAPDSD0053	3.2	50.2	50	0.16	3	★
0.54	VAPDSD0054	3.2	50.2	50	0.16	3	★
0.55	VAPDSD0055	3.2	50.2	50	0.17	3	★
0.56	VAPDSD0056	4.2	50.2	50	0.17	3	★
0.57	VAPDSD0057	4.2	50.2	50	0.17	3	★
0.58	VAPDSD0058	4.2	50.2	50	0.17	3	★
0.59	VAPDSD0059	4.2	50.2	50	0.18	3	★
0.60	VAPDSD0060	5.2	50.2	50	0.18	3	★
0.61	VAPDSD0061	5.2	50.2	50	0.18	3	★
0.62	VAPDSD0062	5.2	50.2	50	0.19	3	★
0.63	VAPDSD0063	5.2	50.2	50	0.19	3	★
0.64	VAPDSD0064	5.2	50.2	50	0.19	3	★
0.65	VAPDSD0065	5.2	50.2	50	0.20	3	★
0.66	VAPDSD0066	5.2	50.2	50	0.20	3	★
0.67	VAPDSD0067	5.2	50.2	50	0.20	3	★
0.68	VAPDSD0068	5.2	50.2	50	0.20	3	★
0.69	VAPDSD0069	5.2	50.2	50	0.21	3	★
0.70	VAPDSD0070	5.2	50.2	50	0.21	3	★
0.71	VAPDSD0071	5.2	50.2	50	0.21	3	★
0.72	VAPDSD0072	5.2	50.2	50	0.22	3	★
0.73	VAPDSD0073	5.2	50.2	50	0.22	3	★
0.74	VAPDSD0074	5.2	50.2	50	0.22	3	★
0.75	VAPDSD0075	5.2	50.2	50	0.23	3	★
0.76	VAPDSD0076	5.2	50.2	50	0.23	3	★
0.77	VAPDSD0077	5.2	50.2	50	0.23	3	★
0.78	VAPDSD0078	5.2	50.2	50	0.23	3	★
0.79	VAPDSD0079	5.2	50.2	50	0.24	3	★
0.80	VAPDSD0080	5.2	50.2	50	0.24	3	★
0.81	VAPDSD0081	5.2	50.2	50	0.24	3	★
0.82	VAPDSD0082	5.3	50.3	50	0.25	3	★

DC (mm)	Numer zamówieniowy	Wymiary (mm)					Dostępność
		LCF	OAL	LF	PL	DCON	
0.83	VAPDSD0083	5.3	50.3	50	0.25	3	★
0.84	VAPDSD0084	5.3	50.3	50	0.25	3	★
0.85	VAPDSD0085	5.3	50.3	50	0.26	3	★
0.86	VAPDSD0086	6.3	50.3	50	0.26	3	★
0.87	VAPDSD0087	6.3	50.3	50	0.26	3	★
0.88	VAPDSD0088	6.3	50.3	50	0.26	3	★
0.89	VAPDSD0089	6.3	50.3	50	0.27	3	★
0.90	VAPDSD0090	6.3	50.3	50	0.27	3	★
0.91	VAPDSD0091	6.3	50.3	50	0.27	3	★
0.92	VAPDSD0092	6.3	50.3	50	0.28	3	★
0.93	VAPDSD0093	6.3	50.3	50	0.28	3	★
0.94	VAPDSD0094	6.3	50.3	50	0.28	3	★
0.95	VAPDSD0095	6.3	50.3	50	0.29	3	★
0.96	VAPDSD0096	6.3	50.3	50	0.29	3	★
0.97	VAPDSD0097	6.3	50.3	50	0.29	3	★
0.98	VAPDSD0098	6.3	50.3	50	0.29	3	★
0.99	VAPDSD0099	6.3	50.3	50	0.30	3	★
1.00	VAPDSD0100	6.3	50.3	50	0.3	3	●
1.01	VAPDSD0101	6.3	50.3	50	0.3	3	★
1.02	VAPDSD0102	6.3	50.3	50	0.3	3	★
1.03	VAPDSD0103	6.3	50.3	50	0.3	3	★
1.04	VAPDSD0104	6.3	50.3	50	0.3	3	★
1.05	VAPDSD0105	6.3	50.3	50	0.3	3	★
1.06	VAPDSD0106	6.3	50.3	50	0.3	3	★
1.07	VAPDSD0107	8.3	55.3	55	0.3	3	★
1.08	VAPDSD0108	8.3	55.3	55	0.3	3	★
1.09	VAPDSD0109	8.3	55.3	55	0.3	3	★
1.10	VAPDSD0110	8.3	55.3	55	0.3	3	★
1.11	VAPDSD0111	8.3	55.3	55	0.3	3	★
1.12	VAPDSD0112	8.3	55.3	55	0.3	3	★
1.13	VAPDSD0113	8.3	55.3	55	0.3	3	★
1.14	VAPDSD0114	8.3	55.3	55	0.3	3	★
1.15	VAPDSD0115	8.4	55.4	55	0.4	3	★

● : Standard magazynowy. ★ : Na specjalne zamówienie z magazynu w Japonii.

DC (mm)	Numer zamówieniowy	Wymiary (mm)					Dostępność
		LCF	OAL	LF	PL	DCON	
1.16	VAPDSD0116	8.4	55.4	55	0.4	3	★
1.17	VAPDSD0117	8.4	55.4	55	0.4	3	★
1.18	VAPDSD0118	8.4	55.4	55	0.4	3	★
1.19	VAPDSD0119	8.4	55.4	55	0.4	3	★
1.20	VAPDSD0120	8.4	55.4	55	0.4	3	★
1.21	VAPDSD0121	8.4	55.4	55	0.4	3	★
1.22	VAPDSD0122	8.4	55.4	55	0.4	3	★
1.23	VAPDSD0123	8.4	55.4	55	0.4	3	★
1.24	VAPDSD0124	8.4	55.4	55	0.4	3	★
1.25	VAPDSD0125	8.4	55.4	55	0.4	3	★
1.26	VAPDSD0126	8.4	55.4	55	0.4	3	★
1.27	VAPDSD0127	8.4	55.4	55	0.4	3	★
1.28	VAPDSD0128	8.4	55.4	55	0.4	3	★
1.29	VAPDSD0129	8.4	55.4	55	0.4	3	★
1.30	VAPDSD0130	9.4	55.4	55	0.4	3	★
1.31	VAPDSD0131	9.4	55.4	55	0.4	3	★
1.32	VAPDSD0132	9.4	55.4	55	0.4	3	★
1.33	VAPDSD0133	9.4	55.4	55	0.4	3	★
1.34	VAPDSD0134	9.4	55.4	55	0.4	3	★
1.35	VAPDSD0135	9.4	55.4	55	0.4	3	★
1.36	VAPDSD0136	9.4	55.4	55	0.4	3	★
1.37	VAPDSD0137	9.4	55.4	55	0.4	3	★
1.38	VAPDSD0138	9.4	55.4	55	0.4	3	★
1.39	VAPDSD0139	9.4	55.4	55	0.4	3	★
1.40	VAPDSD0140	9.4	55.4	55	0.4	3	★
1.41	VAPDSD0141	9.4	55.4	55	0.4	3	★
1.42	VAPDSD0142	9.4	55.4	55	0.4	3	★
1.43	VAPDSD0143	9.4	55.4	55	0.4	3	★
1.44	VAPDSD0144	9.4	55.4	55	0.4	3	★
1.45	VAPDSD0145	9.4	55.4	55	0.4	3	★
1.46	VAPDSD0146	9.4	55.4	55	0.4	3	★
1.47	VAPDSD0147	9.4	55.4	55	0.4	3	★
1.48	VAPDSD0148	9.4	55.4	55	0.4	3	★
1.49	VAPDSD0149	9.5	55.5	55	0.5	3	★
1.50	VAPDSD0150	9.5	55.5	55	0.5	3	●
1.51	VAPDSD0151	11.5	55.5	55	0.5	3	★
1.52	VAPDSD0152	11.5	55.5	55	0.5	3	★
1.53	VAPDSD0153	11.5	55.5	55	0.5	3	★
1.54	VAPDSD0154	11.5	55.5	55	0.5	3	★
1.55	VAPDSD0155	11.5	55.5	55	0.5	3	★
1.56	VAPDSD0156	11.5	55.5	55	0.5	3	★
1.57	VAPDSD0157	11.5	55.5	55	0.5	3	★
1.58	VAPDSD0158	11.5	55.5	55	0.5	3	★
1.59	VAPDSD0159	11.5	55.5	55	0.5	3	★
1.60	VAPDSD0160	11.5	55.5	55	0.5	3	★
1.61	VAPDSD0161	11.5	55.5	55	0.5	3	★
1.62	VAPDSD0162	11.5	55.5	55	0.5	3	★
1.63	VAPDSD0163	11.5	55.5	55	0.5	3	★
1.64	VAPDSD0164	11.5	55.5	55	0.5	3	★
1.65	VAPDSD0165	11.5	55.5	55	0.5	3	★

DC (mm)	Numer zamówieniowy	Wymiary (mm)					Dostępność
		LCF	OAL	LF	PL	DCON	
1.66	VAPDSD0166	11.5	55.5	55	0.5	3	★
1.67	VAPDSD0167	11.5	55.5	55	0.5	3	★
1.68	VAPDSD0168	11.5	55.5	55	0.5	3	★
1.69	VAPDSD0169	11.5	55.5	55	0.5	3	★
1.70	VAPDSD0170	11.5	55.5	55	0.5	3	★
1.71	VAPDSD0171	11.5	55.5	55	0.5	3	★
1.72	VAPDSD0172	11.5	55.5	55	0.5	3	★
1.73	VAPDSD0173	11.5	55.5	55	0.5	3	★
1.74	VAPDSD0174	11.5	55.5	55	0.5	3	★
1.75	VAPDSD0175	11.5	55.5	55	0.5	3	★
1.76	VAPDSD0176	11.5	55.5	55	0.5	3	★
1.77	VAPDSD0177	11.5	55.5	55	0.5	3	★
1.78	VAPDSD0178	11.5	55.5	55	0.5	3	★
1.79	VAPDSD0179	11.5	55.5	55	0.5	3	★
1.80	VAPDSD0180	11.5	55.5	55	0.5	3	★
1.81	VAPDSD0181	11.5	55.5	55	0.5	3	★
1.82	VAPDSD0182	11.6	55.6	55	0.6	3	★
1.83	VAPDSD0183	11.6	55.6	55	0.6	3	★
1.84	VAPDSD0184	11.6	55.6	55	0.6	3	★
1.85	VAPDSD0185	11.6	55.6	55	0.6	3	★
1.86	VAPDSD0186	11.6	55.6	55	0.6	3	★
1.87	VAPDSD0187	11.6	55.6	55	0.6	3	★
1.88	VAPDSD0188	11.6	55.6	55	0.6	3	★
1.89	VAPDSD0189	11.6	55.6	55	0.6	3	★
1.90	VAPDSD0190	12.6	55.6	55	0.6	3	★
1.91	VAPDSD0191	12.6	60.6	60	0.6	3	★
1.92	VAPDSD0192	12.6	60.6	60	0.6	3	★
1.93	VAPDSD0193	12.6	60.6	60	0.6	3	★
1.94	VAPDSD0194	12.6	60.6	60	0.6	3	★
1.95	VAPDSD0195	12.6	60.6	60	0.6	3	★
1.96	VAPDSD0196	12.6	60.6	60	0.6	3	★
1.97	VAPDSD0197	12.6	60.6	60	0.6	3	★
1.98	VAPDSD0198	12.6	60.6	60	0.6	3	★
1.99	VAPDSD0199	12.6	60.6	60	0.6	3	★
2.00	VAPDSD0200	12.4	60.4	60	0.4	3	●
2.05	VAPDSD0205	12.4	60.4	60	0.4	3	★
2.10	VAPDSD0210	12.4	60.4	60	0.4	3	★
2.15	VAPDSD0215	12.5	60.5	60	0.5	3	★
2.20	VAPDSD0220	12.5	60.5	60	0.5	3	★
2.25	VAPDSD0225	12.5	60.5	60	0.5	3	★
2.30	VAPDSD0230	13.5	60.5	60	0.5	3	★
2.35	VAPDSD0235	13.5	60.5	60	0.5	3	★
2.40	VAPDSD0240	13.5	60.5	60	0.5	3	★
2.45	VAPDSD0245	13.5	60.5	60	0.5	3	★
2.50	VAPDSD0250	13.5	60.5	60	0.5	3	●
2.55	VAPDSD0255	13.5	60.5	60	0.5	3	★
2.60	VAPDSD0260	15.5	60.5	60	0.5	3	★
2.65	VAPDSD0265	15.6	60.6	60	0.6	3	★
2.70	VAPDSD0270	15.6	60.6	60	0.6	3	★
2.75	VAPDSD0275	15.6	60.6	60	0.6	3	★

M
WIERCENIE

VAPDS

Krótki rowek wiórowy, podwyższona dokładność

Stal
szybko tnąca

M
WIERCENIE

DC (mm)	Numer zamówieniowy	Wymiary (mm)					Dostępność	DC (mm)	Numer zamówieniowy	Wymiary (mm)					Dostępność
		LCF	OAL	LF	PL	DCON				LCF	OAL	LF	PL	DCON	
2.80	VAPDSD0280	15.6	60.6	60	0.6	3	★	5.30	VAPDSD0530	26.1	81.1	80	1.1	6	★
2.85	VAPDSD0285	15.6	60.6	60	0.6	3	★	5.35	VAPDSD0535	28.1	81.1	80	1.1	6	★
2.90	VAPDSD0290	15.6	60.6	60	0.6	3	★	5.40	VAPDSD0540	28.1	81.1	80	1.1	6	★
2.95	VAPDSD0295	15.6	60.6	60	0.6	3	★	5.45	VAPDSD0545	28.1	81.1	80	1.1	6	★
3.00	VAPDSD0300	15.6	60.6	60	0.6	3	●	5.50	VAPDSD0550	28.1	81.1	80	1.1	6	●
3.05	VAPDSD0305	17.6	70.6	70	0.6	4	★	5.55	VAPDSD0555	28.2	81.2	80	1.2	6	★
3.10	VAPDSD0310	17.6	70.6	70	0.6	4	★	5.60	VAPDSD0560	28.2	81.2	80	1.2	6	★
3.15	VAPDSD0315	17.7	70.7	70	0.7	4	★	5.65	VAPDSD0565	28.2	81.2	80	1.2	6	★
3.20	VAPDSD0320	17.7	70.7	70	0.7	4	★	5.70	VAPDSD0570	28.2	81.2	80	1.2	6	★
3.25	VAPDSD0325	17.7	70.7	70	0.7	4	★	5.75	VAPDSD0575	28.2	81.2	80	1.2	6	★
3.30	VAPDSD0330	19.7	70.7	70	0.7	4	★	5.80	VAPDSD0580	28.2	81.2	80	1.2	6	★
3.35	VAPDSD0335	19.7	70.7	70	0.7	4	★	5.85	VAPDSD0585	28.2	81.2	80	1.2	6	★
3.40	VAPDSD0340	19.7	70.7	70	0.7	4	★	5.90	VAPDSD0590	28.2	81.2	80	1.2	6	★
3.45	VAPDSD0345	19.7	70.7	70	0.7	4	★	5.95	VAPDSD0595	28.2	81.2	80	1.2	6	★
3.50	VAPDSD0350	19.7	70.7	70	0.7	4	●	6.00	VAPDSD0600	28.2	81.2	80	1.2	6	●
3.55	VAPDSD0355	19.7	70.7	70	0.7	4	★	6.05	VAPDSD0605	31.3	81.3	80	1.3	8	★
3.60	VAPDSD0360	21.8	70.8	70	0.8	4	★	6.10	VAPDSD0610	31.3	81.3	80	1.3	8	★
3.65	VAPDSD0365	21.8	70.8	70	0.8	4	★	6.15	VAPDSD0615	31.3	81.3	80	1.3	8	★
3.70	VAPDSD0370	21.8	70.8	70	0.8	4	★	6.20	VAPDSD0620	31.3	81.3	80	1.3	8	★
3.75	VAPDSD0375	21.8	70.8	70	0.8	4	★	6.25	VAPDSD0625	31.3	81.3	80	1.3	8	★
3.80	VAPDSD0380	21.8	70.8	70	0.8	4	★	6.30	VAPDSD0630	31.3	81.3	80	1.3	8	★
3.85	VAPDSD0385	21.8	70.8	70	0.8	4	★	6.35	VAPDSD0635	31.3	81.3	80	1.3	8	★
3.90	VAPDSD0390	21.8	70.8	70	0.8	4	★	6.40	VAPDSD0640	31.3	81.3	80	1.3	8	★
3.95	VAPDSD0395	21.8	70.8	70	0.8	4	★	6.45	VAPDSD0645	31.3	81.3	80	1.3	8	★
4.00	VAPDSD0400	21.8	70.8	70	0.8	4	●	6.50	VAPDSD0650	31.4	81.4	80	1.4	8	●
4.05	VAPDSD0405	21.8	80.8	80	0.8	6	★	6.55	VAPDSD0655	31.4	81.4	80	1.4	8	★
4.10	VAPDSD0410	21.9	80.9	80	0.9	6	★	6.60	VAPDSD0660	31.4	81.4	80	1.4	8	★
4.15	VAPDSD0415	21.9	80.9	80	0.9	6	★	6.65	VAPDSD0665	31.4	81.4	80	1.4	8	★
4.20	VAPDSD0420	21.9	80.9	80	0.9	6	★	6.70	VAPDSD0670	31.4	81.4	80	1.4	8	★
4.25	VAPDSD0425	21.9	80.9	80	0.9	6	★	6.75	VAPDSD0675	33.4	81.4	80	1.4	8	★
4.30	VAPDSD0430	23.9	80.9	80	0.9	6	★	6.80	VAPDSD0680	33.4	81.4	80	1.4	8	★
4.35	VAPDSD0435	23.9	80.9	80	0.9	6	★	6.85	VAPDSD0685	33.4	81.4	80	1.4	8	★
4.40	VAPDSD0440	23.9	80.9	80	0.9	6	★	6.90	VAPDSD0690	33.4	81.4	80	1.4	8	★
4.45	VAPDSD0445	23.9	80.9	80	0.9	6	★	6.95	VAPDSD0695	33.4	81.4	80	1.4	8	★
4.50	VAPDSD0450	23.9	80.9	80	0.9	6	●	7.00	VAPDSD0700	33.5	81.5	80	1.5	8	●
4.55	VAPDSD0455	23.9	80.9	80	0.9	6	★	7.05	VAPDSD0705	33.5	81.5	80	1.5	8	★
4.60	VAPDSD0460	26.0	81.0	80	1.0	6	★	7.10	VAPDSD0710	33.5	81.5	80	1.5	8	★
4.65	VAPDSD0465	26.0	81.0	80	1.0	6	★	7.15	VAPDSD0715	33.5	81.5	80	1.5	8	★
4.70	VAPDSD0470	26.0	81.0	80	1.0	6	★	7.20	VAPDSD0720	33.5	81.5	80	1.5	8	★
4.75	VAPDSD0475	26.0	81.0	80	1.0	6	★	7.25	VAPDSD0725	33.5	81.5	80	1.5	8	★
4.80	VAPDSD0480	26.0	81.0	80	1.0	6	★	7.30	VAPDSD0730	33.5	81.5	80	1.5	8	★
4.85	VAPDSD0485	26.0	81.0	80	1.0	6	★	7.35	VAPDSD0735	33.5	81.5	80	1.5	8	★
4.90	VAPDSD0490	26.0	81.0	80	1.0	6	★	7.40	VAPDSD0740	33.5	81.5	80	1.5	8	★
4.95	VAPDSD0495	26.0	81.0	80	1.0	6	★	7.45	VAPDSD0745	33.5	81.5	80	1.5	8	★
5.00	VAPDSD0500	26.0	81.0	80	1.0	6	●	7.50	VAPDSD0750	33.6	81.6	80	1.6	8	●
5.05	VAPDSD0505	26.1	81.1	80	1.1	6	★	7.55	VAPDSD0755	36.6	86.6	85	1.6	8	★
5.10	VAPDSD0510	26.1	81.1	80	1.1	6	★	7.60	VAPDSD0760	36.6	86.6	85	1.6	8	★
5.15	VAPDSD0515	26.1	81.1	80	1.1	6	★	7.65	VAPDSD0765	36.6	86.6	85	1.6	8	★
5.20	VAPDSD0520	26.1	81.1	80	1.1	6	★	7.70	VAPDSD0770	36.6	86.6	85	1.6	8	★
5.25	VAPDSD0525	26.1	81.1	80	1.1	6	★	7.75	VAPDSD0775	36.6	86.6	85	1.6	8	★

● : Standard magazynowy. ★ : Na specjalne zamówienie z magazynu w Japonii.

DC (mm)	Numer zamówieniowy	Wymiary (mm)					Dostępność
		LCF	OAL	LF	PL	DCON	
7.80	VAPDSD0780	36.6	86.6	85	1.6	8	★
7.85	VAPDSD0785	36.6	86.6	85	1.6	8	★
7.90	VAPDSD0790	36.6	86.6	85	1.6	8	★
7.95	VAPDSD0795	36.7	86.7	85	1.7	8	★
8.00	VAPDSD0800	36.7	86.7	85	1.7	8	●
8.05	VAPDSD0805	36.7	91.7	90	1.7	10	★
8.10	VAPDSD0810	36.7	91.7	90	1.7	10	★
8.15	VAPDSD0815	36.7	91.7	90	1.7	10	★
8.20	VAPDSD0820	36.7	91.7	90	1.7	10	★
8.25	VAPDSD0825	36.7	91.7	90	1.7	10	★
8.30	VAPDSD0830	36.7	91.7	90	1.7	10	★
8.35	VAPDSD0835	36.7	91.7	90	1.7	10	★
8.40	VAPDSD0840	36.7	91.7	90	1.7	10	★
8.45	VAPDSD0845	36.8	91.8	90	1.8	10	★
8.50	VAPDSD0850	36.8	91.8	90	1.8	10	●
8.55	VAPDSD0855	39.8	94.8	93	1.8	10	★
8.60	VAPDSD0860	39.8	94.8	93	1.8	10	★
8.65	VAPDSD0865	39.8	94.8	93	1.8	10	★
8.70	VAPDSD0870	39.8	94.8	93	1.8	10	★
8.75	VAPDSD0875	39.8	94.8	93	1.8	10	★
8.80	VAPDSD0880	39.8	94.8	93	1.8	10	★
8.85	VAPDSD0885	39.8	94.8	93	1.8	10	★
8.90	VAPDSD0890	39.8	94.8	93	1.8	10	★
8.95	VAPDSD0895	39.9	94.9	93	1.9	10	★
9.00	VAPDSD0900	39.9	94.9	93	1.9	10	●
9.10	VAPDSD0910	39.9	94.9	93	1.9	10	★
9.20	VAPDSD0920	39.9	94.9	93	1.9	10	★
9.30	VAPDSD0930	39.9	94.9	93	1.9	10	★
9.40	VAPDSD0940	40.0	95.0	93	2.0	10	★
9.50	VAPDSD0950	40.0	95.0	93	2.0	10	●
9.60	VAPDSD0960	43.0	98.0	96	2.0	10	★
9.70	VAPDSD0970	43.0	98.0	96	2.0	10	★
9.80	VAPDSD0980	43.0	98.0	96	2.0	10	★
9.90	VAPDSD0990	43.1	98.1	96	2.1	10	★
10.00	VAPDSD1000	43.1	98.1	96	2.1	10	●
10.10	VAPDSD1010	43.1	103.1	101	2.1	12	★
10.20	VAPDSD1020	43.1	103.1	101	2.1	12	★
10.30	VAPDSD1030	43.1	103.1	101	2.1	12	★
10.40	VAPDSD1040	43.2	103.2	101	2.2	12	★
10.50	VAPDSD1050	43.2	103.2	101	2.2	12	●
10.60	VAPDSD1060	43.2	103.2	101	2.2	12	★
10.70	VAPDSD1070	47.2	107.2	105	2.2	12	★
10.80	VAPDSD1080	47.2	107.2	105	2.2	12	★
10.90	VAPDSD1090	47.3	107.3	105	2.3	12	★
11.00	VAPDSD1100	47.3	107.3	105	2.3	12	●
11.10	VAPDSD1110	47.3	107.3	105	2.3	12	★
11.20	VAPDSD1120	47.3	107.3	105	2.3	12	★
11.30	VAPDSD1130	47.3	107.3	105	2.3	12	★
11.40	VAPDSD1140	47.4	107.4	105	2.4	12	★
11.50	VAPDSD1150	47.4	107.4	105	2.4	12	★

DC (mm)	Numer zamówieniowy	Wymiary (mm)					Dostępność
		LCF	OAL	LF	PL	DCON	
11.60	VAPDSD1160	47.4	107.4	105	2.4	12	★
11.70	VAPDSD1170	47.4	107.4	105	2.4	12	★
11.80	VAPDSD1180	47.4	107.4	105	2.4	12	★
11.90	VAPDSD1190	51.5	111.5	109	2.5	12	★
12.00	VAPDSD1200	51.5	111.5	109	2.5	12	●
12.10	VAPDSD1210	51.5	111.5	109	2.5	12	★
12.20	VAPDSD1220	51.5	111.5	109	2.5	12	★
12.30	VAPDSD1230	51.6	111.6	109	2.6	12	★
12.40	VAPDSD1240	51.6	111.6	109	2.6	12	★
12.50	VAPDSD1250	51.6	111.6	109	2.6	12	●
12.60	VAPDSD1260	51.6	111.6	109	2.6	12	★
12.70	VAPDSD1270	51.6	111.6	109	2.6	12	★
12.80	VAPDSD1280	51.7	111.7	109	2.7	12	★
12.90	VAPDSD1290	51.7	111.7	109	2.7	12	★
13.00	VAPDSD1300	51.7	111.7	109	2.7	12	★

M

WIERCENIE

ZALECANE PARAMETRY SKRAWANIA

Materiał przedmiotu obrabianego	P		P	K	P	M	P	M
	Obroty (min ⁻¹)	Posuw (mm/obr.)	Obroty (min ⁻¹)	Posuw (mm/obr.)	Obroty (min ⁻¹)	Posuw (mm/obr.)	Obroty (min ⁻¹)	Posuw (mm/obr.)
Stal konstrukcyjna								
Stal węglowa Ck55 Stal stopowa 070M55 Zeliwo								
Stal narzędziowa stopowa X210Cr12 (Materiały o niskiej twardości) Stal nierdzewna o strukturze ferrytycznej X10CrAl18, X10CrAl13 Stal nierdzewna o strukturze martenzytycznej X20Cr13, X10CrAl13								
Stal narzędziowa stopowa X40CrMoV51 (-40HRC) Stal nierdzewna umacniana wydzieleniowo X7CrNiAl177								
Średnica wiertła DC (mm)								
0.5	18000	0.02	16000	0.02	9000	0.02	8200	0.02
1.0	12000	0.05	10000	0.05	6300	0.05	5500	0.04
2.0	6400	0.09	5500	0.09	3200	0.09	2900	0.05
3.0	4300	0.13	3700	0.13	2100	0.13	1900	0.06
4.0	3200	0.15	2800	0.15	1600	0.15	1400	0.08
5.0	2600	0.18	2200	0.18	1300	0.18	1100	0.10
6.0	2100	0.19	1800	0.19	1100	0.20	950	0.11
8.0	1600	0.24	1400	0.24	800	0.22	720	0.13
10.0	1300	0.28	1100	0.28	640	0.25	570	0.15
12.0	1100	0.34	930	0.34	530	0.30	480	0.17
13.0	980	0.36	860	0.36	490	0.32	440	0.19

Uwaga 1) Gdy zamocowanie przedmiotu obrabianego ma małą sztywność lub przy ograniczonej sztywności obrabiarki prosimy o zmniejszenie obrotów i posuwu.

Uwaga 2) Prosimy użyć uchwytu wiertarskiego z tuleją samozaciskową lub uchwytu frezarskiego.

Uwaga 3) Użyć odpowiednich ilości chłodziwa.

Uwaga 4) Podczas wiercenia otworów o średnicy 4-krotnie większej od średnicy wiertła, stosować posuw stopniowy (z wycofaniem wiertła).

Uwaga 5) Podane wyżej parametry skrawania dotyczą chłodziw wodorozcieńczalnych.

W przypadku użycia chłodziwa innego niż wodorozcieńczalne prosimy o zmniejszenie obrotów.

VAPDM

Rowek wiórowy o średniej długości, podwyższona dokładność



Stal
szybkotnąca

DC<2

DC≥2

P M K N S H

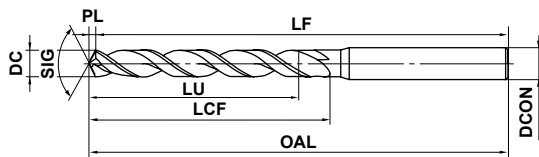

*LU = LCF-2DC (Maks. 5×DC)



$0.5 \leq DC \leq 3$	$3 < DC \leq 6$	$6 < DC \leq 10$	$10 < DC \leq 18$	$18 < DC \leq 30$	$30 < DC \leq 32$
0	0	0	0	0	0
-0.014	-0.018	-0.022	-0.027	-0.033	-0.039

● Dzięki opracowaniu nowej powłoki Violet, osiągnięto dużą wydajność wiercenia oraz długą żywotność narzędzia.

DC (mm)	Numer zamówieniowy	Wymiary (mm)					Dostępność
		LCF	OAL	LF	PL	DCON	
0.50	VAPDMD0050	6.2	50.2	50	0.15	3	●
0.55	VAPDMD0055	6.2	50.2	50	0.17	3	★
0.60	VAPDMD0060	8.2	50.2	50	0.18	3	★
0.65	VAPDMD0065	8.2	50.2	50	0.20	3	★
0.70	VAPDMD0070	10.2	50.2	50	0.21	3	★
0.75	VAPDMD0075	10.2	50.2	50	0.23	3	★
0.80	VAPDMD0080	10.2	50.2	50	0.24	3	★
0.85	VAPDMD0085	10.3	50.3	50	0.26	3	★
0.90	VAPDMD0090	12.3	50.3	50	0.27	3	★
0.95	VAPDMD0095	12.3	50.3	50	0.29	3	★
1.00	VAPDMD0100	12.3	60.3	60	0.3	3	●
1.05	VAPDMD0105	12.3	60.3	60	0.3	3	★
1.10	VAPDMD0110	16.3	60.3	60	0.3	3	★
1.15	VAPDMD0115	16.4	60.4	60	0.4	3	★
1.20	VAPDMD0120	16.4	60.4	60	0.4	3	★
1.25	VAPDMD0125	16.4	60.4	60	0.4	3	★
1.30	VAPDMD0130	16.4	60.4	60	0.4	3	★
1.35	VAPDMD0135	18.4	60.4	60	0.4	3	★
1.40	VAPDMD0140	18.4	60.4	60	0.4	3	★
1.45	VAPDMD0145	18.4	60.4	60	0.4	3	★
1.50	VAPDMD0150	18.5	60.5	60	0.5	3	●
1.55	VAPDMD0155	20.5	60.5	60	0.5	3	★
1.60	VAPDMD0160	20.5	60.5	60	0.5	3	★
1.65	VAPDMD0165	20.5	60.5	60	0.5	3	★
1.70	VAPDMD0170	20.5	60.5	60	0.5	3	★
1.75	VAPDMD0175	20.5	60.5	60	0.5	3	★
1.80	VAPDMD0180	22.5	60.5	60	0.5	3	★
1.85	VAPDMD0185	22.6	60.6	60	0.6	3	★
1.90	VAPDMD0190	22.6	60.6	60	0.6	3	★
1.95	VAPDMD0195	23.6	60.6	60	0.6	3	★
2.00	VAPDMD0200	23.4	70.4	70	0.4	3	●
2.05	VAPDMD0205	23.4	70.4	70	0.4	3	★
2.10	VAPDMD0210	23.4	70.4	70	0.4	3	★

DC (mm)	Numer zamówieniowy	Wymiary (mm)					Dostępność
		LCF	OAL	LF	PL	DCON	
2.15	VAPDMD0215	23.5	70.5	70	0.5	3	★
2.20	VAPDMD0220	26.5	70.5	70	0.5	3	★
2.25	VAPDMD0225	26.5	70.5	70	0.5	3	★
2.30	VAPDMD0230	26.5	70.5	70	0.5	3	★
2.35	VAPDMD0235	26.5	70.5	70	0.5	3	★
2.40	VAPDMD0240	29.5	70.5	70	0.5	3	★
2.45	VAPDMD0245	29.5	70.5	70	0.5	3	★
2.50	VAPDMD0250	29.5	70.5	70	0.5	3	●
2.55	VAPDMD0255	29.5	70.5	70	0.5	3	★
2.60	VAPDMD0260	29.5	70.5	70	0.5	3	★
2.65	VAPDMD0265	29.6	70.6	70	0.6	3	★
2.70	VAPDMD0270	32.6	70.6	70	0.6	3	★
2.75	VAPDMD0275	32.6	70.6	70	0.6	3	★
2.80	VAPDMD0280	32.6	70.6	70	0.6	3	★
2.85	VAPDMD0285	32.6	70.6	70	0.6	3	★
2.90	VAPDMD0290	32.6	70.6	70	0.6	3	★
2.95	VAPDMD0295	32.6	70.6	70	0.6	3	★
3.00	VAPDMD0300	32.6	70.6	70	0.6	3	●
3.05	VAPDMD0305	35.6	85.6	85	0.6	4	★
3.10	VAPDMD0310	35.6	85.6	85	0.6	4	★
3.15	VAPDMD0315	35.7	85.7	85	0.7	4	★
3.20	VAPDMD0320	35.7	85.7	85	0.7	4	★
3.25	VAPDMD0325	35.7	85.7	85	0.7	4	★
3.30	VAPDMD0330	35.7	85.7	85	0.7	4	★
3.35	VAPDMD0335	35.7	85.7	85	0.7	4	★
3.40	VAPDMD0340	38.7	85.7	85	0.7	4	★
3.45	VAPDMD0345	38.7	85.7	85	0.7	4	★
3.50	VAPDMD0350	38.7	85.7	85	0.7	4	●
3.55	VAPDMD0355	38.7	85.7	85	0.7	4	★
3.60	VAPDMD0360	38.8	85.8	85	0.8	4	★
3.65	VAPDMD0365	38.8	85.8	85	0.8	4	★
3.70	VAPDMD0370	38.8	85.8	85	0.8	4	★
3.75	VAPDMD0375	42.8	85.8	85	0.8	4	★

M
WIERCENIE

● : Standard magazynowy. ★ : Na specjalne zamówienie z magazynu w Japonii.

PARAMETRY SKRAWANIA > M182
INFORMACJE TECHNICZNE > P001

M179

VAPDM

Rowek wiórowy o średniej długości, podwyższona dokładność

Stal
szybkotnąca

M
WIERCENIE

DC (mm)	Numer zamówieniowy	Wymiary (mm)					Dostępność	DC (mm)	Numer zamówieniowy	Wymiary (mm)					Dostępność
		LCF	OAL	LF	PL	DCON				LCF	OAL	LF	PL	DCON	
3.80	VAPDMD0380	42.8	85.8	85	0.8	4	★	6.30	VAPDMD0630	63.3	113.3	112	1.3	8	★
3.85	VAPDMD0385	42.8	85.8	85	0.8	4	★	6.35	VAPDMD0635	63.3	113.3	112	1.3	8	★
3.90	VAPDMD0390	42.8	85.8	85	0.8	4	★	6.40	VAPDMD0640	63.3	113.3	112	1.3	8	★
3.95	VAPDMD0395	42.8	85.8	85	0.8	4	★	6.45	VAPDMD0645	63.3	113.3	112	1.3	8	★
4.00	VAPDMD0400	42.8	85.8	85	0.8	4	●	6.50	VAPDMD0650	63.4	113.4	112	1.4	8	●
4.05	VAPDMD0405	42.8	100.8	100	0.8	6	★	6.55	VAPDMD0655	63.4	113.4	112	1.4	8	★
4.10	VAPDMD0410	42.9	100.9	100	0.9	6	★	6.60	VAPDMD0660	63.4	113.4	112	1.4	8	★
4.15	VAPDMD0415	42.9	100.9	100	0.9	6	★	6.65	VAPDMD0665	63.4	113.4	112	1.4	8	★
4.20	VAPDMD0420	42.9	100.9	100	0.9	6	★	6.70	VAPDMD0670	63.4	113.4	112	1.4	8	★
4.25	VAPDMD0425	46.9	100.9	100	0.9	6	★	6.75	VAPDMD0675	68.4	118.4	117	1.4	8	★
4.30	VAPDMD0430	46.9	100.9	100	0.9	6	★	6.80	VAPDMD0680	68.4	118.4	117	1.4	8	★
4.35	VAPDMD0435	46.9	100.9	100	0.9	6	★	6.85	VAPDMD0685	68.4	118.4	117	1.4	8	★
4.40	VAPDMD0440	46.9	100.9	100	0.9	6	★	6.90	VAPDMD0690	68.4	118.4	117	1.4	8	★
4.45	VAPDMD0445	46.9	100.9	100	0.9	6	★	6.95	VAPDMD0695	68.4	118.4	117	1.4	8	★
4.50	VAPDMD0450	46.9	100.9	100	0.9	6	●	7.00	VAPDMD0700	68.5	118.5	117	1.5	8	●
4.55	VAPDMD0455	46.9	100.9	100	0.9	6	★	7.05	VAPDMD0705	68.5	118.5	117	1.5	8	★
4.60	VAPDMD0460	47.0	101.0	100	1.0	6	★	7.10	VAPDMD0710	68.5	118.5	117	1.5	8	★
4.65	VAPDMD0465	47.0	101.0	100	1.0	6	★	7.15	VAPDMD0715	68.5	118.5	117	1.5	8	★
4.70	VAPDMD0470	47.0	101.0	100	1.0	6	★	7.20	VAPDMD0720	68.5	118.5	117	1.5	8	★
4.75	VAPDMD0475	47.0	101.0	100	1.0	6	★	7.25	VAPDMD0725	68.5	118.5	117	1.5	8	★
4.80	VAPDMD0480	52.0	101.0	100	1.0	6	★	7.30	VAPDMD0730	68.5	118.5	117	1.5	8	★
4.85	VAPDMD0485	52.0	101.0	100	1.0	6	★	7.35	VAPDMD0735	68.5	118.5	117	1.5	8	★
4.90	VAPDMD0490	52.0	101.0	100	1.0	6	★	7.40	VAPDMD0740	68.5	118.5	117	1.5	8	★
4.95	VAPDMD0495	52.0	101.0	100	1.0	6	★	7.45	VAPDMD0745	68.5	118.5	117	1.5	8	★
5.00	VAPDMD0500	52.0	101.0	100	1.0	6	●	7.50	VAPDMD0750	68.6	118.6	117	1.6	8	●
5.05	VAPDMD0505	52.1	101.1	100	1.1	6	★	7.55	VAPDMD0755	74.6	124.6	123	1.6	8	★
5.10	VAPDMD0510	52.1	101.1	100	1.1	6	★	7.60	VAPDMD0760	74.6	124.6	123	1.6	8	★
5.15	VAPDMD0515	52.1	101.1	100	1.1	6	★	7.65	VAPDMD0765	74.6	124.6	123	1.6	8	★
5.20	VAPDMD0520	52.1	101.1	100	1.1	6	★	7.70	VAPDMD0770	74.6	124.6	123	1.6	8	★
5.25	VAPDMD0525	52.1	101.1	100	1.1	6	★	7.75	VAPDMD0775	74.6	124.6	123	1.6	8	★
5.30	VAPDMD0530	52.1	101.1	100	1.1	6	★	7.80	VAPDMD0780	74.6	124.6	123	1.6	8	★
5.35	VAPDMD0535	57.1	107.1	106	1.1	6	★	7.85	VAPDMD0785	74.6	124.6	123	1.6	8	★
5.40	VAPDMD0540	57.1	107.1	106	1.1	6	★	7.90	VAPDMD0790	74.6	124.6	123	1.6	8	★
5.45	VAPDMD0545	57.1	107.1	106	1.1	6	★	7.95	VAPDMD0795	74.7	124.7	123	1.7	8	★
5.50	VAPDMD0550	57.1	107.1	106	1.1	6	●	8.00	VAPDMD0800	74.7	124.7	123	1.7	8	●
5.55	VAPDMD0555	57.2	107.2	106	1.2	6	★	8.05	VAPDMD0805	74.7	129.7	128	1.7	10	★
5.60	VAPDMD0560	57.2	107.2	106	1.2	6	★	8.10	VAPDMD0810	74.7	129.7	128	1.7	10	★
5.65	VAPDMD0565	57.2	107.2	106	1.2	6	★	8.15	VAPDMD0815	74.7	129.7	128	1.7	10	★
5.70	VAPDMD0570	57.2	107.2	106	1.2	6	★	8.20	VAPDMD0820	74.7	129.7	128	1.7	10	★
5.75	VAPDMD0575	57.2	107.2	106	1.2	6	★	8.25	VAPDMD0825	74.7	129.7	128	1.7	10	★
5.80	VAPDMD0580	57.2	107.2	106	1.2	6	★	8.30	VAPDMD0830	74.7	129.7	128	1.7	10	★
5.85	VAPDMD0585	57.2	107.2	106	1.2	6	★	8.35	VAPDMD0835	74.7	129.7	128	1.7	10	★
5.90	VAPDMD0590	57.2	107.2	106	1.2	6	★	8.40	VAPDMD0840	74.7	129.7	128	1.7	10	★
5.95	VAPDMD0595	57.2	107.2	106	1.2	6	★	8.45	VAPDMD0845	74.8	129.8	128	1.8	10	★
6.00	VAPDMD0600	57.2	107.2	106	1.2	6	●	8.50	VAPDMD0850	74.8	129.8	128	1.8	10	●
6.05	VAPDMD0605	63.3	113.3	112	1.3	8	★	8.55	VAPDMD0855	80.8	135.8	134	1.8	10	★
6.10	VAPDMD0610	63.3	113.3	112	1.3	8	★	8.60	VAPDMD0860	80.8	135.8	134	1.8	10	★
6.15	VAPDMD0615	63.3	113.3	112	1.3	8	★	8.65	VAPDMD0865	80.8	135.8	134	1.8	10	★
6.20	VAPDMD0620	63.3	113.3	112	1.3	8	★	8.70	VAPDMD0870	80.8	135.8	134	1.8	10	★
6.25	VAPDMD0625	63.3	113.3	112	1.3	8	★	8.75	VAPDMD0875	80.8	135.8	134	1.8	10	★

● : Standard magazynowy. ★ : Na specjalne zamówienie z magazynu w Japonii.

DC (mm)	Numer zamówieniowy	Wymiary (mm)					Dostępność
		LCF	OAL	LF	PL	DCON	
8.80	VAPDMD0880	80.8	135.8	134	1.8	10	★
8.85	VAPDMD0885	80.8	135.8	134	1.8	10	★
8.90	VAPDMD0890	80.8	135.8	134	1.8	10	★
8.95	VAPDMD0895	80.9	135.9	134	1.9	10	★
9.00	VAPDMD0900	80.9	135.9	134	1.9	10	●
9.10	VAPDMD0910	80.9	135.9	134	1.9	10	★
9.20	VAPDMD0920	80.9	135.9	134	1.9	10	★
9.30	VAPDMD0930	80.9	135.9	134	1.9	10	★
9.40	VAPDMD0940	81.0	136.0	134	2.0	10	★
9.50	VAPDMD0950	81.0	136.0	134	2.0	10	●
9.60	VAPDMD0960	87.0	142.0	140	2.0	10	★
9.70	VAPDMD0970	87.0	142.0	140	2.0	10	★
9.80	VAPDMD0980	87.0	142.0	140	2.0	10	★
9.90	VAPDMD0990	87.1	142.1	140	2.1	10	★
10.00	VAPDMD1000	87.1	142.1	140	2.1	10	●
10.10	VAPDMD1010	87.1	147.1	145	2.1	12	★
10.20	VAPDMD1020	87.1	147.1	145	2.1	12	★
10.30	VAPDMD1030	87.1	147.1	145	2.1	12	★
10.40	VAPDMD1040	87.2	147.2	145	2.2	12	★
10.50	VAPDMD1050	87.2	147.2	145	2.2	12	●
10.60	VAPDMD1060	87.2	147.2	145	2.2	12	★
10.70	VAPDMD1070	94.2	154.2	152	2.2	12	★
10.80	VAPDMD1080	94.2	154.2	152	2.2	12	★
10.90	VAPDMD1090	94.3	154.3	152	2.3	12	★
11.00	VAPDMD1100	94.3	154.3	152	2.3	12	●
11.10	VAPDMD1110	94.3	154.3	152	2.3	12	★
11.20	VAPDMD1120	94.3	154.3	152	2.3	12	★
11.30	VAPDMD1130	94.3	154.3	152	2.3	12	★
11.40	VAPDMD1140	94.4	154.4	152	2.4	12	★
11.50	VAPDMD1150	94.4	154.4	152	2.4	12	●
11.60	VAPDMD1160	94.4	154.4	152	2.4	12	★
11.70	VAPDMD1170	94.4	154.4	152	2.4	12	★
11.80	VAPDMD1180	94.4	154.4	152	2.4	12	★
11.90	VAPDMD1190	101.5	161.5	159	2.5	12	★
12.00	VAPDMD1200	101.5	161.5	159	2.5	12	●
12.10	VAPDMD1210	101.5	161.5	159	2.5	12	★
12.20	VAPDMD1220	101.5	161.5	159	2.5	12	★
12.30	VAPDMD1230	101.6	161.6	159	2.6	12	★
12.40	VAPDMD1240	101.6	161.6	159	2.6	12	★
12.50	VAPDMD1250	101.6	161.6	159	2.6	12	●
12.60	VAPDMD1260	101.6	161.6	159	2.6	12	★
12.70	VAPDMD1270	101.6	161.6	159	2.6	12	★
12.80	VAPDMD1280	101.7	161.7	159	2.7	12	★
12.90	VAPDMD1290	101.7	161.7	159	2.7	12	★
13.00	VAPDMD1300	101.7	161.7	159	2.7	12	●
13.50	VAPDMD1350	102.8	162.8	160	2.8	16	●
14.00	VAPDMD1400	102.9	162.9	160	2.9	16	●
14.10	VAPDMD1410	107.9	167.9	165	2.9	16	★
14.20	VAPDMD1420	107.9	167.9	165	2.9	16	★
14.50	VAPDMD1450	108.0	168.0	165	3.0	16	●
15.00	VAPDMD1500	108.1	168.1	165	3.1	16	●

DC (mm)	Numer zamówieniowy	Wymiary (mm)					Dostępność
		LCF	OAL	LF	PL	DCON	
15.50	VAPDMD1550	113.2	173.2	170	3.2	16	★
15.60	VAPDMD1560	113.2	173.2	170	3.2	16	★
15.70	VAPDMD1570	113.3	173.3	170	3.3	16	★
16.00	VAPDMD1600	113.3	173.3	170	3.3	16	●
16.50	VAPDMD1650	113.4	178.4	175	3.4	20	●
17.00	VAPDMD1700	113.5	178.5	175	3.5	20	●
17.50	VAPDMD1750	118.6	183.6	180	3.6	20	●
17.60	VAPDMD1760	118.7	183.7	180	3.7	20	★
17.70	VAPDMD1770	118.7	183.7	180	3.7	20	★
18.00	VAPDMD1800	118.7	183.7	180	3.7	20	●
18.50	VAPDMD1850	123.8	188.8	185	3.8	20	★
19.00	VAPDMD1900	123.9	188.9	185	3.9	20	★
19.50	VAPDMD1950	124.0	189.0	185	4.0	20	★
19.60	VAPDMD1960	124.1	189.1	185	4.1	20	★
19.70	VAPDMD1970	124.1	189.1	185	4.1	20	★
20.00	VAPDMD2000	124.1	189.1	185	4.1	20	★
20.50	VAPDMD2050	129.3	204.3	200	4.3	25	●
21.00	VAPDMD2100	129.4	204.4	200	4.4	25	●
21.10	VAPDMD2110	129.4	204.4	200	4.4	25	★
21.20	VAPDMD2120	129.4	204.4	200	4.4	25	★
21.50	VAPDMD2150	129.5	204.5	200	4.5	25	★
22.00	VAPDMD2200	129.6	204.6	200	4.6	25	●
22.50	VAPDMD2250	134.7	209.7	205	4.7	25	★
23.00	VAPDMD2300	134.8	209.8	205	4.8	25	●
23.50	VAPDMD2350	134.9	209.9	205	4.9	25	★
24.00	VAPDMD2400	140.0	215.0	210	5.0	25	★
24.50	VAPDMD2450	140.1	215.1	210	5.1	25	★
25.00	VAPDMD2500	140.2	215.2	210	5.2	25	★
25.50	VAPDMD2550	145.3	225.3	220	5.3	32	●
26.00	VAPDMD2600	145.4	225.4	220	5.4	32	★
26.50	VAPDMD2650	145.5	225.5	220	5.5	32	★
27.00	VAPDMD2700	145.6	225.6	220	5.6	32	★
28.00	VAPDMD2800	145.8	225.8	220	5.8	32	★
29.00	VAPDMD2900	151.0	231.0	225	6.0	32	★
30.00	VAPDMD3000	151.2	231.2	225	6.2	32	★
31.00	VAPDMD3100	156.4	236.4	230	6.4	32	★
32.00	VAPDMD3200	161.6	241.6	235	6.6	32	★

M

WIERCENIE

ZALECANE PARAMETRY SKRAWANIA (Standardowa głębokość wiercenia : maksymalnie 5-krotność średnicy wiertła)

Materiał przedmiotu obrabianego	P		P	K	P	M	P	M
	Stal konstrukcyjna		Stal węglowa Ck55 Stal stopowa 070M55 Zeliwo		Stal narzędziowa stopowa X210Cr12 (Materiały o niskiej twardości) Stal nierdzewna o strukturze ferrytycznej X10CrAl18, X10CrAl13 Stal nierdzewna o strukturze martenzytycznej X20Cr13, X10CrAl13		Stal narzędziowa stopowa X40CrMoV51 (-40HRC) Stal nierdzewna umacniana wydzieleniowo X7CrNiAl177	
Średnica wiertła DC (mm)	Obroty (min ⁻¹)	Posuw (mm/obr.)	Obroty (min ⁻¹)	Posuw (mm/obr.)	Obroty (min ⁻¹)	Posuw (mm/obr.)	Obroty (min ⁻¹)	Posuw (mm/obr.)
0.5	17000	0.01	12800	0.01	8000	0.01	6600	0.01
1.0	11000	0.05	8300	0.05	5000	0.05	4100	0.04
2.0	6400	0.09	4800	0.09	2900	0.06	2400	0.05
3.0	4300	0.13	3200	0.13	1900	0.10	1600	0.06
4.0	3200	0.15	2400	0.15	1400	0.10	1200	0.08
5.0	2600	0.18	1900	0.18	1100	0.13	950	0.10
6.0	2100	0.19	1600	0.20	950	0.15	800	0.11
8.0	1600	0.24	1200	0.22	720	0.18	600	0.13
10.0	1300	0.28	950	0.25	570	0.21	480	0.15
12.0	1100	0.34	800	0.30	480	0.25	400	0.17
14.0	910	0.39	680	0.35	410	0.30	340	0.21
15.0	850	0.40	640	0.36	380	0.31	320	0.22
16.0	800	0.42	600	0.38	360	0.32	300	0.23
18.0	710	0.44	530	0.40	320	0.34	270	0.24
20.0	570	0.44	450	0.40	250	0.34	220	0.24
22.0	520	0.46	410	0.42	230	0.36	200	0.25
24.0	480	0.48	370	0.44	210	0.37	190	0.26
26.0	440	0.51	340	0.46	200	0.39	170	0.28
28.0	410	0.53	320	0.48	180	0.41	160	0.29
30.0	380	0.55	300	0.50	170	0.43	150	0.30
32.0	360	0.55	280	0.50	160	0.43	140	0.30

Uwaga 1) Gdy zamocowanie przedmiotu obrabianego ma małą sztywność lub przy ograniczonej sztywności obrabiarki prosimy o zmniejszenie obrotów i posuwu.

Uwaga 2) Prosimy użyć uchwytu wiertarskiego z tuleją samozaciskową lub uchwytu frezarskiego.

Uwaga 3) Użyć odpowiednich ilości chłodziwa.

Uwaga 4) Podczas wiercenia otworów o średnicy 4-krotnie większej od średnicy wiertła, stosować posuw stopniowy (z wycofaniem wiertła).

Uwaga 5) Podane wyżej parametry skrawania dotyczą chłodziw wodorozcieńczalnych.

W przypadku użycia chłodziwa innego niż wodorozcieńczalne prosimy o zmniejszenie obrotów.



DC < 0.7

DC ≥ 0.7

DC < 2

DC ≥ 2

P M K N S H

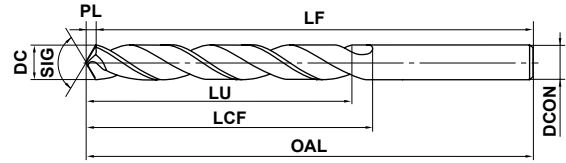

*LU = LCF - 2DC



0.5 ≤ DC ≤ 1	1 ≤ DC ≤ 3	3 < DC ≤ 6	6 < DC ≤ 10	10 < DC ≤ 13
0 -0.010	0 -0.014	0 -0.018	0 -0.022	0 -0.027

DC (mm)	Numer zamówieniowy	Wymiary (mm)					Dostępność
		LCF	OAL	LF	PL	DCON	
0.5	VSDD0050	6.2	27.2	27	0.18	0.5	★
0.6	VSDD0060	7.2	30.2	30	0.21	0.6	●
0.7	VSDD0070	9.2	32.2	32	0.21	0.7	●
0.8	VSDD0080	10.2	34.2	34	0.24	0.8	●
0.9	VSDD0090	11.3	36.3	36	0.27	0.9	●
1.0	VSDD0100	12.3	40.3	40	0.3	1.0	●
1.1	VSDD0110	14.3	42.3	42	0.3	1.1	●
1.2	VSDD0120	16.4	42.4	42	0.4	1.2	●
1.3	VSDD0130	16.4	45.4	45	0.4	1.3	●
1.4	VSDD0140	18.4	48.4	48	0.4	1.4	●
1.5	VSDD0150	18.5	48.5	48	0.5	1.5	●
1.6	VSDD0160	20.5	50.5	50	0.5	1.6	●
1.7	VSDD0170	20.5	50.5	50	0.5	1.7	★
1.8	VSDD0180	22.5	52.5	52	0.5	1.8	●
1.9	VSDD0190	22.6	52.6	52	0.6	1.9	●
2.0	VSDD0200	23.6	55.6	55	0.6	2.0	●
2.1	VSDD0210	23.6	55.6	55	0.6	2.1	●
2.2	VSDD0220	26.7	58.7	58	0.7	2.2	●
2.3	VSDD0230	26.7	58.7	58	0.7	2.3	★
2.4	VSDD0240	29.7	61.7	61	0.7	2.4	★
2.5	VSDD0250	29.8	61.8	61	0.8	2.5	●
2.6	VSDD0260	29.8	64.8	64	0.8	2.6	★
2.7	VSDD0270	32.8	64.8	64	0.8	2.7	★
2.8	VSDD0280	32.8	67.8	67	0.8	2.8	●
2.9	VSDD0290	32.9	71.9	71	0.9	2.9	★
3.0	VSDD0300	32.9	71.9	71	0.9	3.0	●
3.1	VSDD0310	35.9	71.9	71	0.9	3.1	●
3.2	VSDD0320	36.0	72.0	71	1.0	3.2	●
3.3	VSDD0330	36.0	74.0	73	1.0	3.3	●
3.4	VSDD0340	39.0	74.0	73	1.0	3.4	●
3.5	VSDD0350	39.1	74.1	73	1.1	3.5	●
3.6	VSDD0360	39.1	77.1	76	1.1	3.6	★
3.7	VSDD0370	39.1	77.1	76	1.1	3.7	★
3.8	VSDD0380	43.1	77.1	76	1.1	3.8	★
3.9	VSDD0390	43.2	80.2	79	1.2	3.9	★
4.0	VSDD0400	43.2	84.2	83	1.2	4.0	●
4.1	VSDD0410	43.2	84.2	83	1.2	4.1	●
4.2	VSDD0420	43.3	84.3	83	1.3	4.2	●
4.3	VSDD0430	47.3	84.3	83	1.3	4.3	●
4.4	VSDD0440	47.3	87.3	86	1.3	4.4	★

DC (mm)	Numer zamówieniowy	Wymiary (mm)					Dostępność
		LCF	OAL	LF	PL	DCON	
4.5	VSDD0450	47.4	87.4	86	1.4	4.5	●
4.6	VSDD0460	47.4	87.4	86	1.4	4.6	★
4.7	VSDD0470	47.4	90.4	89	1.4	4.7	★
4.8	VSDD0480	52.4	90.4	89	1.4	4.8	●
4.9	VSDD0490	52.5	93.5	92	1.5	4.9	★
5.0	VSDD0500	52.5	93.5	92	1.5	5.0	●
5.1	VSDD0510	52.5	93.5	92	1.5	5.1	●
5.2	VSDD0520	52.6	96.6	95	1.6	5.2	●
5.3	VSDD0530	52.6	96.6	95	1.6	5.3	★
5.4	VSDD0540	57.6	96.6	95	1.6	5.4	★
5.5	VSDD0550	57.7	96.7	95	1.7	5.5	●
5.6	VSDD0560	57.7	99.7	98	1.7	5.6	★
5.7	VSDD0570	57.7	99.7	98	1.7	5.7	★
5.8	VSDD0580	57.7	99.7	98	1.7	5.8	★
5.9	VSDD0590	57.8	99.8	98	1.8	5.9	●
6.0	VSDD0600	57.8	103.8	102	1.8	6.0	●
6.1	VSDD0610	63.8	103.8	102	1.8	6.1	★
6.2	VSDD0620	63.9	103.9	102	1.9	6.2	●
6.3	VSDD0630	63.9	103.9	102	1.9	6.3	●
6.4	VSDD0640	63.9	106.9	105	1.9	6.4	★
6.5	VSDD0650	64.0	107.0	105	2.0	6.5	●
6.6	VSDD0660	64.0	107.0	105	2.0	6.6	★
6.7	VSDD0670	64.0	107.0	105	2.0	6.7	★
6.8	VSDD0680	69.0	107.0	105	2.0	6.8	●
6.9	VSDD0690	69.1	107.1	105	2.1	6.9	★
7.0	VSDD0700	69.1	107.1	105	2.1	7.0	●
7.1	VSDD0710	69.1	110.1	108	2.1	7.1	★
7.2	VSDD0720	69.2	110.2	108	2.2	7.2	★
7.3	VSDD0730	69.2	110.2	108	2.2	7.3	●
7.4	VSDD0740	69.2	113.2	111	2.2	7.4	★
7.5	VSDD0750	69.3	113.3	111	2.3	7.5	★
7.6	VSDD0760	75.3	113.3	111	2.3	7.6	★
7.7	VSDD0770	75.3	116.3	114	2.3	7.7	★
7.8	VSDD0780	75.3	116.3	114	2.3	7.8	★
7.9	VSDD0790	75.4	116.4	114	2.4	7.9	●
8.0	VSDD0800	75.4	116.4	114	2.4	8.0	●
8.1	VSDD0810	75.4	119.4	117	2.4	8.1	★
8.2	VSDD0820	75.5	119.5	117	2.5	8.2	★
8.3	VSDD0830	75.5	119.5	117	2.5	8.3	★
8.4	VSDD0840	75.5	123.5	121	2.5	8.4	★

Uwaga 1) Wiertła o średnicy ø5-ø1.9mm: 5 szt./opakowanie, o średnicy powyżej ø2mm: 1 szt./opakowanie

● : Standard magazynowy. ★ : Na specjalne zamówienie z magazynu w Japonii.

PARAMETRY SKRAWANIA > M184
INFORMACJE TECHNICZNE > P001

DC (mm)	Numer zamówieniowy	Wymiary (mm)					Dostępność	DC (mm)	Numer zamówieniowy	Wymiary (mm)					Dostępność
		LCF	OAL	LF	PL	DCON				LCF	OAL	LF	PL	DCON	
8.5	VSDD0850	75.6	123.6	121	2.6	8.5	●	10.8	VSDD1080	95.2	143.2	140	3.2	10.8	★
8.6	VSDD0860	81.6	123.6	121	2.6	8.6	●	10.9	VSDD1090	95.3	143.3	140	3.3	10.9	★
8.7	VSDD0870	81.6	123.6	121	2.6	8.7	●	11.0	VSDD1100	95.3	143.3	140	3.3	11.0	●
8.8	VSDD0880	81.6	126.6	124	2.6	8.8	★	11.1	VSDD1110	95.3	143.3	140	3.3	11.1	★
8.9	VSDD0890	81.7	126.7	124	2.7	8.9	★	11.2	VSDD1120	95.4	146.4	143	3.4	11.2	★
9.0	VSDD0900	81.7	126.7	124	2.7	9.0	●	11.3	VSDD1130	95.4	146.4	143	3.4	11.3	★
9.1	VSDD0910	81.7	126.7	124	2.7	9.1	★	11.4	VSDD1140	95.4	146.4	143	3.4	11.4	★
9.2	VSDD0920	81.8	129.8	127	2.8	9.2	★	11.5	VSDD1150	95.5	146.5	143	3.5	11.5	★
9.3	VSDD0930	81.8	129.8	127	2.8	9.3	★	11.6	VSDD1160	95.5	149.5	146	3.5	11.6	★
9.4	VSDD0940	81.8	129.8	127	2.8	9.4	★	11.7	VSDD1170	95.5	149.5	146	3.5	11.7	★
9.5	VSDD0950	81.9	129.9	127	2.9	9.5	●	11.8	VSDD1180	95.5	149.5	146	3.5	11.8	★
9.6	VSDD0960	87.9	132.9	130	2.9	9.6	★	11.9	VSDD1190	102.6	149.6	146	3.6	11.9	★
9.7	VSDD0970	87.9	132.9	130	2.9	9.7	★	12.0	VSDD1200	102.6	152.6	149	3.6	12.0	●
9.8	VSDD0980	87.9	132.9	130	2.9	9.8	★	12.1	VSDD1210	102.6	152.6	149	3.6	12.1	★
9.9	VSDD0990	88.0	133.0	130	3.0	9.9	★	12.2	VSDD1220	102.7	152.7	149	3.7	12.2	★
10.0	VSDD1000	88.0	133.0	130	3.0	10.0	●	12.3	VSDD1230	102.7	152.7	149	3.7	12.3	★
10.1	VSDD1010	88.0	136.0	133	3.0	10.1	★	12.4	VSDD1240	102.7	155.7	152	3.7	12.4	★
10.2	VSDD1020	88.1	136.1	133	3.1	10.2	●	12.5	VSDD1250	102.8	155.8	152	3.8	12.5	★
10.3	VSDD1030	88.1	136.1	133	3.1	10.3	●	12.6	VSDD1260	102.8	155.8	152	3.8	12.6	★
10.4	VSDD1040	88.1	136.1	133	3.1	10.4	★	12.7	VSDD1270	102.8	155.8	152	3.8	12.7	★
10.5	VSDD1050	88.2	140.2	137	3.2	10.5	●	12.8	VSDD1280	102.8	155.8	152	3.8	12.8	★
10.6	VSDD1060	88.2	140.2	137	3.2	10.6	★	12.9	VSDD1290	102.9	155.9	152	3.9	12.9	★
10.7	VSDD1070	95.2	140.2	137	3.2	10.7	★	13.0	VSDD1300	102.9	155.9	152	3.9	13.0	●

ZALECANE PARAMETRY SKRAWANIA

Materiał przedmiotu obrabianego	P		M		P		M	
	Stal konstrukcyjna		Stal węglowa Ck55		Stal nierdzewna X20Cr13		Stal nierdzewna X5CrNi1810 Stal narzędziowa X210Cr12 (Materiały o niskiej twardości) Stal obrobiona cieplnie X40CrMoV51 (-40HRC)	
Prędkość skrawania	40m/min		30m/min		20m/min		10-14m/min	
Średnica wiertła DC (mm)	Obroty (min ⁻¹)	Posuw (mm/obr.)	Obroty (min ⁻¹)	Posuw (mm/obr.)	Obroty (min ⁻¹)	Posuw (mm/obr.)	Obroty (min ⁻¹)	Posuw (mm/obr.)
0.5	15000	0.01	11250	0.01	7500	0.01	5620	0.01
1.0	10000	0.02	7500	0.02	5000	0.02	3750	0.02
1.5	8200	0.03	6150	0.03	4100	0.03	2800	0.03
2.0	6370	0.05	4780	0.05	3180	0.05	2200	0.04
3.0	4250	0.10	3180	0.10	2120	0.07	1400	0.06
4.0	3180	0.13	2390	0.13	1590	0.09	1100	0.08
5.0	2550	0.15	1910	0.15	1270	0.11	860	0.10
6.0	2120	0.18	1590	0.18	1060	0.13	720	0.11
7.0	1820	0.20	1360	0.20	910	0.14	610	0.12
8.0	1590	0.22	1190	0.21	800	0.15	540	0.13
9.0	1420	0.24	1060	0.22	710	0.17	480	0.14
10.0	1270	0.26	960	0.23	640	0.18	430	0.15
11.0	1160	0.28	870	0.24	580	0.19	390	0.16
12.0	1060	0.30	800	0.25	530	0.20	360	0.17
13.0	980	0.30	730	0.26	490	0.20	330	0.17

Uwaga 1) Gdy zamocowanie przedmiotu obrabianego ma małą sztywność, prosimy o zmniejszenie obrotów i posuwu.

Uwaga 2) Podane wyżej parametry skrawania dotyczą chłodziw wodorozcieńczalnych.

W przypadku użycia chłodziwa innego niż wodorozcieńczalne prosimy o zmniejszenie obrotów.

VAPDSCB

Krótki rowek wiórowy, podwyższona dokładność, do pogłębiania czołowego



Stal
szybkotnąca

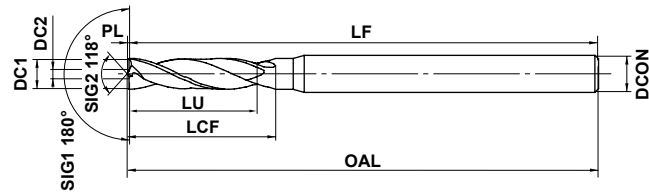

*LU = LCF - 2DC (Maks. 3×DC)



DC ≤ 3	3 < DC ≤ 6	6 < DC ≤ 10	10 < DC ≤ 18	18 < DC ≤ 30	30 < DC ≤ 32
0	0	0	0	0	0
-0.014	-0.018	-0.022	-0.027	-0.033	-0.039

- Unikalna geometria zapewnia wysoką wydajność pogłębiania czołowego. Doskonałe łamanie wióra i płaska powierzchnia po obróbce.

M
WIERCENIE

DC1 (mm)	Numer zamówieniowy	Wymiary (mm)						Dostępność
		DC2	LCF	OAL	LF	PL	DCON	
2.0	VAPDSCBD0200	0.7	12	60.2	60	0.2	3	★
2.1	VAPDSCBD0210	0.7	12	60.2	60	0.2	3	★
2.2	VAPDSCBD0220	0.7	12	60.2	60	0.2	3	★
2.3	VAPDSCBD0230	0.7	13	60.2	60	0.2	3	★
2.4	VAPDSCBD0240	0.7	13	60.2	60	0.2	3	★
2.5	VAPDSCBD0250	0.7	13	60.2	60	0.2	3	★
2.6	VAPDSCBD0260	0.8	15	60.2	60	0.2	3	★
2.7	VAPDSCBD0270	0.8	15	60.2	60	0.2	3	★
2.8	VAPDSCBD0280	0.8	15	60.2	60	0.2	3	★
2.9	VAPDSCBD0290	0.8	15	60.2	60	0.2	3	★
3.0	VAPDSCBD0300	0.8	15	60.2	60	0.2	3	★
3.1	VAPDSCBD0310	0.8	17	70.2	70	0.2	4	★
3.2	VAPDSCBD0320	0.8	17	70.2	70	0.2	4	★
3.3	VAPDSCBD0330	0.8	19	70.2	70	0.2	4	★
3.4	VAPDSCBD0340	0.8	19	70.2	70	0.2	4	★
3.5	VAPDSCBD0350	0.8	19	70.2	70	0.2	4	★
3.6	VAPDSCBD0360	1.0	21	70.2	70	0.2	4	★
3.7	VAPDSCBD0370	1.0	21	70.2	70	0.2	4	★
3.8	VAPDSCBD0380	1.0	21	70.2	70	0.2	4	★
3.9	VAPDSCBD0390	1.0	21	70.2	70	0.2	4	★
4.0	VAPDSCBD0400	1.0	21	70.3	70	0.3	4	★
4.1	VAPDSCBD0410	1.0	21	80.3	80	0.3	6	★
4.2	VAPDSCBD0420	1.0	21	80.3	80	0.3	6	★
4.3	VAPDSCBD0430	1.0	23	80.3	80	0.3	6	★
4.4	VAPDSCBD0440	1.0	23	80.3	80	0.3	6	★
4.5	VAPDSCBD0450	1.0	23	80.3	80	0.3	6	★
4.6	VAPDSCBD0460	1.4	25	80.3	80	0.3	6	★
4.7	VAPDSCBD0470	1.4	25	80.3	80	0.3	6	★
4.8	VAPDSCBD0480	1.4	25	80.3	80	0.3	6	★
4.9	VAPDSCBD0490	1.4	25	80.3	80	0.3	6	★
5.0	VAPDSCBD0500	1.4	25	80.4	80	0.4	6	★
5.1	VAPDSCBD0510	1.4	25	80.4	80	0.4	6	★
5.2	VAPDSCBD0520	1.4	25	80.4	80	0.4	6	★
5.3	VAPDSCBD0530	1.4	25	80.4	80	0.4	6	★
5.4	VAPDSCBD0540	1.4	27	80.4	80	0.4	6	★
5.5	VAPDSCBD0550	1.4	27	80.4	80	0.4	6	★
5.6	VAPDSCBD0560	1.4	27	80.4	80	0.4	6	★
5.7	VAPDSCBD0570	1.4	27	80.4	80	0.4	6	★
5.8	VAPDSCBD0580	1.4	27	80.4	80	0.4	6	★
5.9	VAPDSCBD0590	1.4	27	80.4	80	0.4	6	★

DC1 (mm)	Numer zamówieniowy	Wymiary (mm)						Dostępność
		DC2	LCF	OAL	LF	PL	DCON	
6.0	VAPDSCBD0600	1.4	27	80.4	80	0.4	6	★
6.1	VAPDSCBD0610	1.4	30	80.4	80	0.4	8	★
6.2	VAPDSCBD0620	1.4	30	80.4	80	0.4	8	★
6.3	VAPDSCBD0630	1.4	30	80.4	80	0.4	8	★
6.4	VAPDSCBD0640	1.4	30	80.4	80	0.4	8	★
6.5	VAPDSCBD0650	1.4	30	80.4	80	0.4	8	★
6.6	VAPDSCBD0660	1.8	30	80.4	80	0.4	8	★
6.7	VAPDSCBD0670	1.8	30	80.4	80	0.4	8	★
6.8	VAPDSCBD0680	1.8	32	80.4	80	0.4	8	★
6.9	VAPDSCBD0690	1.8	32	80.4	80	0.4	8	★
7.0	VAPDSCBD0700	1.8	32	80.6	80	0.6	8	★
7.1	VAPDSCBD0710	1.8	32	80.6	80	0.6	8	★
7.2	VAPDSCBD0720	1.8	32	80.6	80	0.6	8	★
7.3	VAPDSCBD0730	1.8	32	80.6	80	0.6	8	★
7.4	VAPDSCBD0740	1.8	32	80.6	80	0.6	8	★
7.5	VAPDSCBD0750	1.8	32	80.6	80	0.6	8	★
7.6	VAPDSCBD0760	2.0	35	85.6	85	0.6	8	★
7.7	VAPDSCBD0770	2.0	35	85.6	85	0.6	8	★
7.8	VAPDSCBD0780	2.0	35	85.6	85	0.6	8	★
7.9	VAPDSCBD0790	2.0	35	85.6	85	0.6	8	★
8.0	VAPDSCBD0800	2.0	35	85.6	85	0.6	8	★
8.1	VAPDSCBD0810	2.0	35	90.6	90	0.6	10	★
8.5	VAPDSCBD0850	2.0	35	90.6	90	0.6	10	★
8.6	VAPDSCBD0860	2.8	38	93.6	93	0.6	10	★
8.8	VAPDSCBD0880	2.8	38	93.6	93	0.6	10	★
9.0	VAPDSCBD0900	2.8	38	93.8	93	0.8	10	★
9.1	VAPDSCBD0910	2.8	38	93.8	93	0.8	10	★
9.5	VAPDSCBD0950	2.8	38	93.8	93	0.8	10	★
9.6	VAPDSCBD0960	3.2	41	96.8	96	0.8	10	★
9.8	VAPDSCBD0980	3.2	41	96.8	96	0.8	10	★
10.0	VAPDSCBD1000	3.2	41	96.9	96	0.9	10	★
10.1	VAPDSCBD1010	3.2	41	101.9	101	0.9	12	★
10.3	VAPDSCBD1030	3.2	41	101.9	101	0.9	12	★
10.5	VAPDSCBD1050	3.2	41	101.9	101	0.9	12	★
10.8	VAPDSCBD1080	3.7	45	105.9	105	0.9	12	★
11.0	VAPDSCBD1100	3.7	45	105.9	105	0.9	12	★
11.1	VAPDSCBD1110	3.7	45	105.9	105	0.9	12	★
11.5	VAPDSCBD1150	3.7	45	105.9	105	0.9	12	★
11.8	VAPDSCBD1180	3.7	45	105.9	105	0.9	12	★
12.0	VAPDSCBD1200	3.7	49	109.9	109	0.9	12	★

★ : Na specjalne zamówienie z magazynu w Japonii.

PARAMETRY SKRAWANIA > M187
INFORMACJE TECHNICZNE > P001

M185

VAPDSCB

Krótki rowek wiórowy, podwyższona dokładność, do pogłębiania czołowego

Stal
szybko tnąca

M
WIERCENIE

DC1 (mm)	Numer zamówieniowy	Wymiary (mm)						Dostępność
		DC2	LCF	OAL	LF	PL	DCON	
12.5	VAPDSCBD1250	3.7	49	109.9	109	0.9	12	★
13.0	VAPDSCBD1300	4.2	49	110.1	109	1.1	12	★
13.5	VAPDSCBD1350	4.2	51	122.1	121	1.1	16	★
13.8	VAPDSCBD1380	4.2	51	122.1	121	1.1	16	★
14.0	VAPDSCBD1400	4.2	51	122.1	121	1.1	16	★
14.1	VAPDSCBD1410	5.5	58	124.1	123	1.1	16	★
14.2	VAPDSCBD1420	5.5	58	124.1	123	1.1	16	★
14.5	VAPDSCBD1450	5.5	58	124.1	123	1.1	16	★
14.8	VAPDSCBD1480	5.5	58	124.1	123	1.1	16	★
15.0	VAPDSCBD1500	5.5	58	124.3	123	1.3	16	★
15.5	VAPDSCBD1550	5.5	60	126.3	125	1.3	16	★
15.7	VAPDSCBD1570	5.5	60	126.3	125	1.3	16	★
15.8	VAPDSCBD1580	5.5	60	126.3	125	1.3	16	★
16.0	VAPDSCBD1600	5.5	60	126.3	125	1.3	16	★
17.0	VAPDSCBD1700	5.5	62	133.3	132	1.3	20	★
17.5	VAPDSCBD1750	5.5	63	134.6	133	1.6	20	★
17.6	VAPDSCBD1760	6.5	63	134.6	133	1.6	20	★
17.7	VAPDSCBD1770	6.5	63	134.6	133	1.6	20	★
17.8	VAPDSCBD1780	6.5	63	134.6	133	1.6	20	★
18.0	VAPDSCBD1800	6.5	63	134.6	133	1.6	20	★
18.1	VAPDSCBD1810	6.5	65	136.6	135	1.6	20	★
19.0	VAPDSCBD1900	6.5	65	136.6	135	1.6	20	★
19.8	VAPDSCBD1980	7.5	67	138.6	137	1.6	20	★
20.0	VAPDSCBD2000	7.5	67	138.8	137	1.8	20	★
20.1	VAPDSCBD2010	7.5	67	138.8	137	1.8	20	★
21.0	VAPDSCBD2100	7.5	75	166.8	165	1.8	25	★
22.0	VAPDSCBD2200	7.5	75	166.8	165	1.8	25	★
23.0	VAPDSCBD2300	7.5	80	171.8	170	1.8	25	★
24.0	VAPDSCBD2400	8.5	80	172.2	170	2.2	25	★
25.0	VAPDSCBD2500	8.5	85	182.2	180	2.2	25	★
26.0	VAPDSCBD2600	9.0	85	182.2	180	2.2	32	★
27.0	VAPDSCBD2700	9.0	95	192.2	190	2.2	32	★
28.0	VAPDSCBD2800	10.0	95	192.6	190	2.6	32	★
29.0	VAPDSCBD2900	10.0	100	197.6	195	2.6	32	★
30.0	VAPDSCBD3000	11.0	100	197.6	195	2.6	32	★
31.0	VAPDSCBD3100	11.0	105	202.6	200	2.6	32	★
32.0	VAPDSCBD3200	13.0	105	202.6	200	2.6	32	★

★ : Na specjalne zamówienie z magazynu w Japonii.

ZALECANE PARAMETRY SKRAWANIA

Materiał przedmiotu obrabianego	P		N		P		K		P		M	
	Stal konstrukcyjna, Sropy aluminium		Stal węglowa Ck55, Stal stopowa 070M55, Żeliwo sferoidalne (GGG)		Stal narzędziowa stopowa X210Cr12, (Materiały o niskiej twardości) Stal nierdzewna o strukturze ferrytycznej, X10CrAl18, X10CrAl13 Stal nierdzewna o strukturze martenzytycznej, X20Cr13, X10CrAl13		Stal narzędziowa stopowa, X40CrMoV51 (-40HRC) Stal nierdzewna utwardzana wydzieleniowo, X7CrNiAl177					
Średnica wiertła DC (mm)	Obroty (min ⁻¹)	Posuw (mm/obr.)	Obroty (min ⁻¹)	Posuw (mm/obr.)	Obroty (min ⁻¹)	Posuw (mm/obr.)	Obroty (min ⁻¹)	Posuw (mm/obr.)	Obroty (min ⁻¹)	Posuw (mm/obr.)	Obroty (min ⁻¹)	Posuw (mm/obr.)
2.0	5600	0.07	4800	0.07	3200	0.07	2800	0.04				
3.0	3700	0.10	3200	0.10	2100	0.10	1900	0.05				
4.0	2800	0.12	2400	0.12	1600	0.12	1400	0.06				
5.0	2200	0.14	1900	0.14	1300	0.14	1150	0.07				
6.0	1850	0.15	1600	0.15	1050	0.15	950	0.08				
8.0	1400	0.20	1200	0.20	800	0.20	720	0.10				
10.0	1100	0.23	960	0.23	640	0.21	570	0.11				
12.0	950	0.26	800	0.26	530	0.24	470	0.12				
14.0	800	0.27	680	0.27	450	0.25	410	0.13				
16.0	700	0.28	500	0.28	360	0.26	300	0.14				
18.0	620	0.29	450	0.29	320	0.27	260	0.15				
20.0	560	0.30	400	0.30	290	0.27	240	0.15				
22.0	510	0.32	360	0.32	260	0.29	220	0.16				
24.0	460	0.33	330	0.33	240	0.30	200	0.16				
26.0	430	0.35	310	0.35	220	0.31	180	0.17				
28.0	400	0.36	290	0.36	210	0.33	170	0.18				
30.0	370	0.37	270	0.37	190	0.34	160	0.18				
32.0	350	0.38	250	0.38	180	0.35	150	0.19				

Uwaga 1) Podane wyżej parametry skrawania dotyczą wiercenia otworów o głębokości DCx3 bez otworu pilotowego.

Podczas wiercenia otworów o głębokości mniejszej od DCx1, obroty można zwiększyć o 20%.

Uwaga 2) Zalecane jest wiercenie bez otworu pilotowego.

Jeśli występuje otwór pilotowy, wiór może nie łamać się. W razie konieczności łamania wióra, stosować posuw stopniowy (z wycofaniem wiertła).

Uwaga 3) Podczas pogłębiania czołowego na powierzchni pochylej zalecane jest stosowanie freza palcowego pełnowęglkowego.

Uwaga 4) Podczas obróbki austenitycznych stali nierdzewnych (X5CrNi1810), zmniejszyć obroty o 30 - 60% i posuw o 40 - 60%.

Uwaga 5) Prosimy użyć uchwytu wiertarskiego z tuleją samozaciskową.

Uwaga 6) Gdy sztywność zamocowania przedmiotu obrabianego jest za niska, prosimy o zmniejszenie obrotów i posuwu odpowiednio do sytuacji.









Uwaga 7) Użyć odpowiednich ilości chłodziwa.

Uwaga 8) Podane wyżej parametry skrawania dotyczą chłodziw wodorozcieńczalnych.

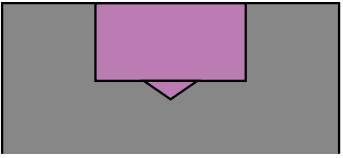
W przypadku użycia chłodziwa innego niż wodorozcieńczalne prosimy o zmniejszenie obrotów.

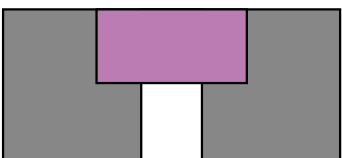
ZALECANA METODA OBRÓBK

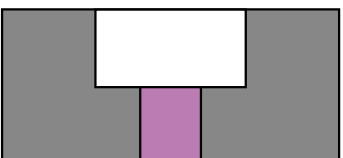
■ Wiertło VAPDSCB zapewnia zachowanie wysokiej wydajności przy wydajnym odprowadzaniu wióra.

Obróbka standardowa		Obróbka z wykorzystaniem wiertła VAPDSCB	
<p>① Wiercenie otworu</p> 	<p>Geometria wióra</p> 	<p>① Pogłębianie czołowe</p> 	<p>Geometria wióra</p> 
<p>② Pogłębianie czołowe</p> 	<p>Wiór skłębiony</p> 	<p>② Wiercenie otworu</p> 	<p>Prawidłowy</p> 

Uwaga 1) Podczas pogłębiania czołowego za pomocą wiertel VAPDSCB z wykorzystaniem otworu pilotowego, może powstawać wiór ciągły i owijać się wokół narzędzia.

WIERCENIE (WIERTŁA PEŁNOWĘGLIKOWE)

WĘGLIKI
SPIEKANE

MCC



P M K N S H **CFRP**



Maszyna CNC

X

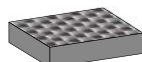

CFRP

M

WIERCENIE

Chłodzenie zewnętrzne

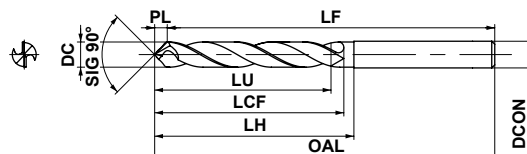

	3<DC≤6	6<DC≤10	10<DC≤18	18<DC≤20
	0 -0.018	0 -0.022	0 -0.027	0 -0.033
	D<CON=6	6<D<CON≤10	10<D<CON≤12	
	0 -0.008	0 -0.009	0 -0.011	

Średnica Otworu Mocującego		Średnica Wiertła		Głębokość Otworu (L/D)	Numer zamówieniowy	Gatunek	Wymiary (mm)						
*AWG	cal	DC (mm)	cal				DD2105	LU	LCF	LH	OAL	LF	PL
—	3/16	4.76	.1875	3	MCC0476X03S060	★	16.7	40	40	80	77.6	2.4	6
—	1/4	6.38	.251	3	MCC0638X03S080	★	22.3	50	50	90	86.8	3.2	8
—	5/16	7.96	.3125	3	MCC0796X03S080	★	27.9	50	50	90	86.0	4.0	8
—	3/8	9.55	.375	3	MCC0955X03S100	★	33.5	50	50	100	95.2	4.8	10
—	7/16	11.14	.4375	3	MCC1114X03S120	★	39.0	60	60	110	104.4	5.6	12

*AWG : American Wire Gage

ZALECANE PARAMETRY SKRAWANIA

Materiał przedmiotu obrabianego		X			
		CFRP			
Średnica wiertła DC (mm)	Średnica wiertła DC (cal)	Prędkość skrawania (m/min)	Obroty (min ⁻¹)	Posuw (Min.—Maks.) (mm/obr.)	Posuw stołu (mm/min)
4.76	.1875	100	6700	0.08 (0.05—0.12)	540
6.38	.251	100	5000	0.1 (0.05—0.12)	500
7.96	.3125	100	4000	0.1 (0.05—0.12)	400
9.55	.375	100	3400	0.1 (0.05—0.12)	340
11.14	.4375	100	2900	0.1 (0.05—0.12)	290

★ : Na specjalne zamówienie z magazynu w Japonii. □ : Niestandardowy, produkowany na specjalne zamówienie.

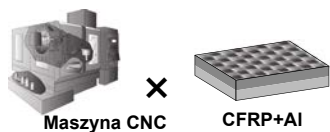

Chłodzenie wewnętrzne

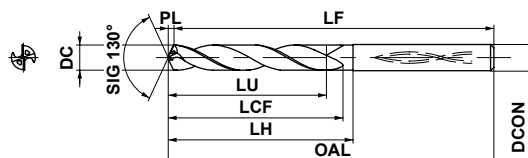

	$6 < DC \leq 10$
	0 -0.022
	$6 < DCON \leq 10$
	0 -0.009

Średnica Otworu Mocującego		Średnica Wiertła		Głębokość Otworu (L/D)	Numer zamówieniowy	Gatunek	Wymiary (mm)						
AWG*	cal	DC (mm)	cal				DD2110	LU	LCF	LH	OAL	LF	PL
—	1/4	6.38	.251	5	MCA0638X05S070	<input type="checkbox"/>	33.4	51	51	91	89.5	1.5	7
—	3/8	9.55	.375	5	MCA0955X05S100	<input type="checkbox"/>	50.0	77	77	118	115.8	2.2	10

*AWG : American Wire Gage

ZALECANE PARAMETRY SKRAWANIA

Materiał przedmiotu obrabianego		X				N			
		CFRP				Stopy aluminium (Si<5%) ASTM A6061, ASTM A7075 etc			
Średnica wiertła DC (mm)	Średnica wiertła DC (cal)	Prędkość skrawania (m/min)	Obroty (min ⁻¹)	Posuw (Min.—Maks.) (mm/obr.)	Posuw stołu (mm/min)	Prędkość skrawania (m/min)	Obroty (min ⁻¹)	Posuw (Min.—Maks.) (mm/obr.)	Posuw stołu (mm/min)
6.38	.251	100	5000	0.15 (0.10—0.20)	750	100	5000	0.03 (0.02—0.04)	150
9.55	.375	100	3400	0.15 (0.10—0.20)	680	100	3400	0.03 (0.02—0.04)	100

Uwaga 1) Zalecamy rozdzielać parametry skrawania dla każdego materiału.

WIERCENIE (WIERTŁA PEŁNOWĘGLIKOWE)

WĘGLIKI
SPIEKANE

MCT



P M K N **S** H CFRP+Ti



Maszyna CNC

X

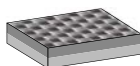

CFRP+Ti

M

WIERCENIE

Chłodzenie wewnętrzne

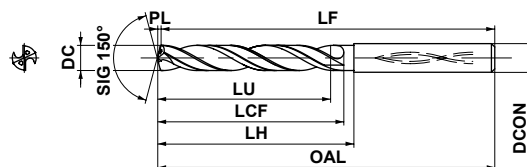

	$6 < DC \leq 10$
	0
	-0.022
	$6 < DCON \leq 10$
	0
	-0.009

Średnica Otworu Mocującego		Średnica Wiertła		Głębokość Otworu	Numer zamówieniowy	Gatunek	Wymiary (mm)						
AWG *	cal	DC (mm)	cal				(L/D)	TF15	LU	LCF	LH	OAL	LF
—	1/4	6.38	.251	5	MCT0638X05S070	<input type="checkbox"/>	32.8	47	47	96	95.1	0.9	7
—	3/8	9.55	.375	5	MCT0955X05S100	<input type="checkbox"/>	49.1	71	71	122	120.7	1.3	10

*AWG : American Wire Gage

ZALECANE PARAMETRY SKRAWANIA

Materiał przedmiotu obrabianego		X				S				
		CFRP				Stop tytanu Ti-6Al-4V itd.				
Średnica wiertła DC (mm)	Średnica wiertła DC (cal)	Prędkość skrawania (m/min)	Obroty (min ⁻¹)	Posuw (Min.—Maks.) (mm/obr.)	Posuw stołu (mm/min)	Prędkość skrawania (m/min)	Obroty (min ⁻¹)	Posuw (Min.—Maks.) (mm/obr.)	Posuw stołu (mm/min)	Głębokość po jakiej należy odwirować narzędzie (mm)
6.38	.251	100	5000	0.15 (0.10—0.20)	750	15	750	0.02 (0.01—0.03)	15	1
9.55	.375	100	3400	0.15 (0.10—0.20)	680	15	500	0.02 (0.01—0.03)	10	1

Uwaga 1) Parametry zalecane gdy stosowane jest wewnętrzne chłodzenie mgłą olejową lub nadmuchem powietrza.

Uwaga 2) Zalecamy rozdzielać parametry skrawania dla każdego materiału.

: Niestandardowy, produkowany na specjalne zamówienie.

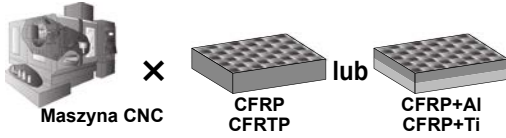

Chłodzenie wewnętrzne

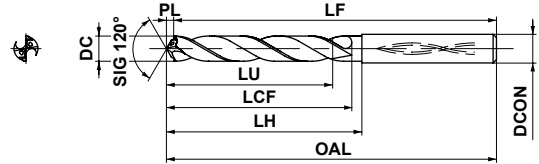

	$6 < DC \leq 10$ 0 -0.022
	$6 < DCON \leq 10$ 0 -0.009

Średnica Otworu Mocującego	Średnica Wiertła				Głębokość Otworu (L/D)	Numer zamówieniowy	Gatunek		Wymiary (mm)						
	AWG *	cal	DC (mm)	cal			HT10	DD2110	LU	LCF	LH	OAL	LF	PL	DCON
—	1/4	6.38	.251	5	MCW0638X05S070	<input type="checkbox"/>	<input type="checkbox"/>	33.7	52	52	92	90.2	1.8	7	
—	3/8	9.55	.375	5	MCW0955X05S100	<input type="checkbox"/>	<input type="checkbox"/>	50.6	73	73	119	116.2	2.8	10	

*AWG : American Wire Gage

ZALECANE PARAMETRY SKRAWANIA

Materiał przedmiotu obrabianego		X				
		CFRP				
Średnica wiertła DC (mm)	Średnica wiertła DC (cal)	Prędkość skrawania (m/min)	Obroty (min ⁻¹)	Posuw (Min.—Maks.) (mm/obr.)	Posuw stołu (mm/min)	
6.38	.251	100	5000	0.15 (0.10—0.20)	750	
9.55	.375	100	3400	0.15 (0.10—0.20)	680	

Materiał przedmiotu obrabianego		N					S				
		Stopy aluminium (Si<5%) A6061, A7075 itd.					Stop tytanu Ti-6Al-4V itd.				
Średnica wiertła DC (mm)	Średnica wiertła DC (cal)	Prędkość skrawania (m/min)	Obroty (min ⁻¹)	Posuw (Min.—Maks.) (mm/obr.)	Posuw stołu (mm/min)	Głębokość po jakiej należy odwirować narzędzie (mm)	Prędkość skrawania (m/min)	Obroty (min ⁻¹)	Posuw (Min.—Maks.) (mm/obr.)	Posuw stołu (mm/min)	Głębokość po jakiej należy odwirować narzędzie (mm)
6.38	.251	100	5000	0.15 (0.10—0.20)	750	3	15	750	0.02 (0.01—0.03)	15	1
9.55	.375	100	3400	0.15 (0.10—0.20)	500	3	15	500	0.02 (0.01—0.03)	10	1

Uwaga 1) Parametry zalecane gdy stosowane jest wewnętrzne chłodzenie mgłą olejową lub nadmuchem powietrza.

Uwaga 2) Zalecamy rozdzielać parametry skrawania dla każdego materiału.

WIERCENIE (WIERTŁA PEŁNOWĘGLIKOWE)

WĘGLIKI
SPIEKANE

MCCH



P M K **N** S H CFRP



X

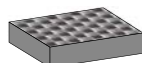

Narzędzie ręczne

CFRP

M

WIERCENIE

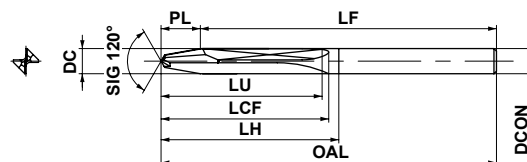

	1 ≤ DC ≤ 3	3 < DC ≤ 6	6 < DC ≤ 10
	0 -0.014	0 -0.018	0 -0.022
	DCON=3	3 < DCON ≤ 6	6 < DCON ≤ 10
	0 -0.006	0 -0.008	0 -0.009

Średnica Otworu Mocującego	Średnica Wiertła			Głębokość Otworu (L/D)	Numer zamówieniowy	Gatunek	Wymiary (mm)						
	AWG*	cal	DC (mm)				cal	DT2030	LU	LCF	LH	OAL	LF
#40	—	2.5	.0985	15	MCCH0250X15S030	★	42.1	48	50	100	95.4	4.6	3
#30	—	3.26	.1285	10	MCCH0326X10S040	★	38.6	48	50	100	94.0	6.0	4
#20	—	4.1	.1615	8	MCCH0410X08S050	★	40.3	48	50	100	92.5	7.5	5
#11	—	4.86	.1915	5	MCCH0486X05S050	★	33.2	48	50	100	91.1	8.9	5
—	1/4	6.38	.251	3	MCCH0638X03S070	★	30.8	48	50	100	88.3	11.7	7
—	3/8	9.55	.375	2	MCCH0955X02S100	★	36.6	48	50	100	82.5	17.5	10

*AWG : American Wire Gage

Uwaga 1) Należy zapoznać się z instrukcją obsługi narzędzia ręcznego w celu sprawdzenia parametrów skrawania.

★ : Na specjalne zamówienie z magazynu w Japonii.

MCAH



WĘGLIKI
SPIEKANE

P M K **N** S H CFRP+AI



X

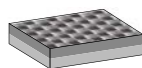

Narzędzie ręczne

CFRP+AI

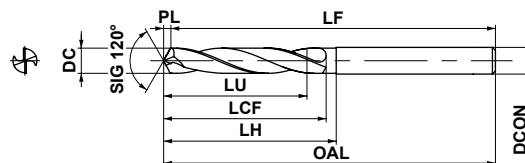

M

WIERCENIE

	$1 \leq DC \leq 3$	$3 < DC \leq 6$	$6 < DC \leq 10$
	0 -0.014	0 -0.018	0 -0.022
	$DCON=3$	$3 < DCON \leq 6$	$6 < DCON \leq 10$
	0 -0.006	0 -0.008	0 -0.009

Średnica Otworu Mocującego	Średnica Wiertła			Głębokość Otworu	Numer zamówieniowy	Gatunek	Wymiary (mm)						
	AWG*	cal	DC (mm)				cal	(L/D)	DT2030	LU	LCF	LH	OAL
#40	—	2.5	.0985	15	MCAH0250X15S030	★	38.2	50	50	100	99.3	0.7	3
#30	—	3.26	.1285	15	MCAH0326X15S040	★	49.8	50	50	100	99.1	0.9	4
#20	—	4.1	.1615	10	MCAH0410X10S050	★	42.2	50	50	100	98.8	1.2	5
#11	—	4.86	.1915	8	MCAH0486X08S050	★	40.3	50	50	100	98.6	1.4	5
—	1/4	6.38	.251	5	MCAH0638X05S070	★	33.7	50	50	100	98.2	1.8	7
—	3/8	9.55	.375	3	MCAH0955X03S100	★	31.5	50	50	100	97.2	2.8	10

*AWG : American Wire Gage

Uwaga 1) Należy zapoznać się z instrukcją obsługi narzędzia ręcznego w celu sprawdzenia parametrów skrawania.

Notatki

A series of horizontal dashed lines for writing notes, spanning the width of the page.

CZĘŚCI ZAPASOWE

SPOSÓB OZNACZANIA N002

CZĘŚCI ZAPASOWE

WKRĘT DOCISKOWY N003

ŚRUBA USTALAJĄCA N009

ŚRUBA REGULACYJNA N010

PŁYTKA PODPOROWA N011

KOŁKI I DŹWIGNIE MOCUJĄCE N014

KOŁEK USTALAJĄCY N015

PŁYTKA DOCISKOWA N015

ŁAMACZ WIÓRA N017

SMAR ZAPOBIEGAJĄCY ZATARCIU N018



SPOSÓB OZNACZANIA

CZĘŚCI ZAPASOWE

■ SPOSÓB OZNACZANIA WKRĘTÓW MOCUJĄCYCH (Gwint metryczny zwykły, prawy)

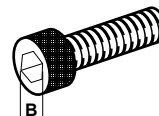

H SC 060 05

Długość

Średnica wkręta

Przykład	
Symbol literowy	L
05	5
10	10
20	20
30	30

Przykład	
Symbol literowy	d
050	M5
060	M6

● Wymiary gniazd sześciokątnych

Średnica	Skok	B Wymiary			
		HBH	HFC	HSC	HS \odot
M2	0.4	—	—	1.5	0.9
M2.5	0.45	—	—	2	1.3
M3	0.5	2	2	2.5	1.5
M4	0.7	2.5	2.5	3	2
M5	0.8	3	3	4	2.5
M6	1	4	4	5	3
M8	1.25	5	5	6	4
M10	1.5	6	6	8	5

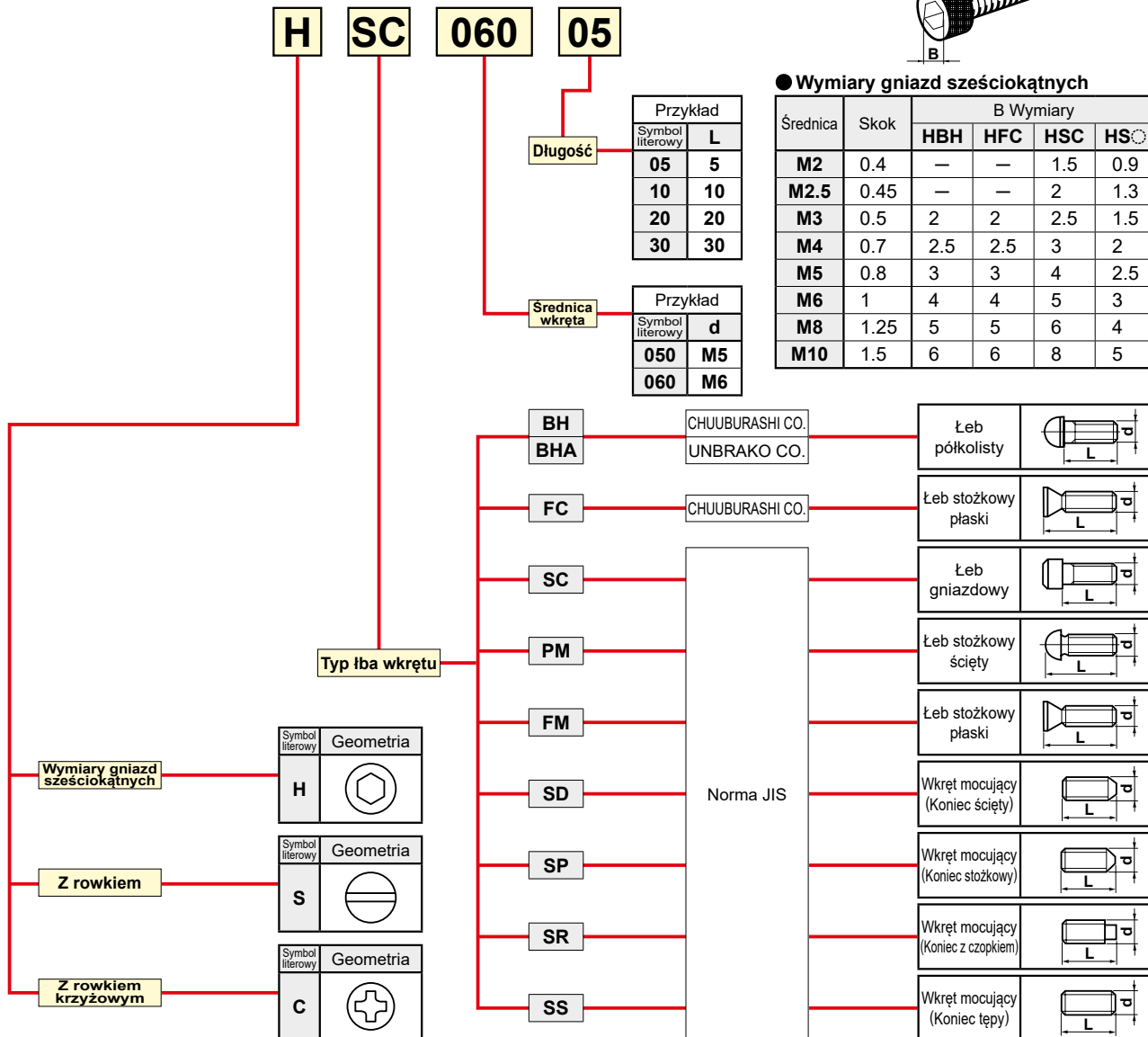

■ SPOSÓB OZNACZANIA KLUCZY

HKY 15 R

Symbol literowy	Typ klucza
HKY	Klucz trzpieniowy sześciokątny
TKY	Klucz typu Torx
RKY	Klucz typu R
TIP	Klucz typu Torx plus

Klucz trzpieniowy sześciokątny		
Symbol literowy	B	
15	1.5	
20	2	
25	2.5	
30	3	
35	3.5	
40	4	
50	5	
60	6	

Klucz typu Torx		
Symbol literowy	B	Wielkość
06	1.7	T6
08	2.3	T8
10	2.7	T10
15	3.3	T15
20	3.8	T20
25	4.4	T25
27	5.0	T27
30	5.5	T30

Klucz typu Torx plus		
Symbol literowy	B	Wielkość
06	1.8	6IP
07	2.1	7IP
08	2.4	8IP
10	2.8	10IP
15	3.4	15IP

R	Standardowy klucz fajkowy	
L	Przedłużony klucz fajkowy	
T	Klucz T	
F	Klucz flagowy	
FS	Klucz flagowy	
W	Klucz flagowy	
D	Śrubokręt	
DS	Śrubokręt	
S	Klucz	

IMX 10 - WR

Symbol literowy	Typ klucza
IMX	Typ klucza dla serii IMX

Klucz trzpieniowy sześciokątny		
Symbol literowy	B	
10	8	
12	10	
16	13	
20	16	
25	20	

WR

CZĘŚCI ZAPASOWE

WKREŃ DOCISKOWY

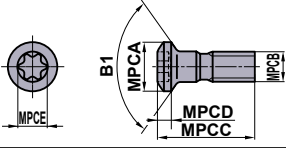
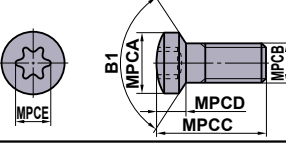
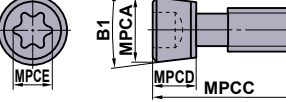
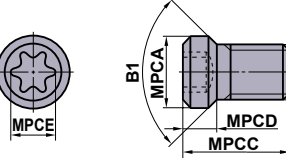
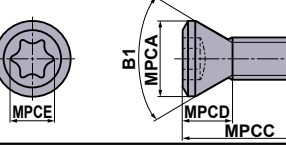
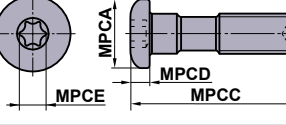
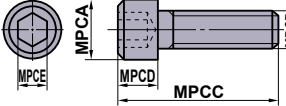

Geometria	Numer zamówieniowy	Wymiary (mm)					Kąt B1	MPCDS	TQ (N·m)	Nazwa oprawki
		MPCA	MPCB	MPCC	MPCD	MPCE				
	AJS3010T10	5	M3×0.5	10	1.5	2.8	120°	T10	2.5	Oprawka Profil (⊕C032) AJX (⊕K180) AJX (⊕K180)
	AJS4012T15	7	M4×0.7	12	2.2	3.4	120°	T15	3.5	
	AJS5014T25	8	M5×0.8	14	2.7	4.5	120°	T25	7.5	
	BRS103	5	M3×0.5	9.9	2.9	3.4	120°	T15	3.5	
	BRS105	8	M5×0.8	13.8	3.8	4.5	120°	T25	7.5	
	CAS51T	7.9	M5×0.8	19	5	4.5	10°	T25	8.5	
	CS200T	3.2	M2×0.4	5	1.6	1.8	90°	T6	0.6	Oprawki wytaczarskie typu F (⊕E027) Narzędzia do frezowania (⊕K001) BRP (⊕K190) DCCC (⊕K200) Oprawki wytaczarskie typu MMTI (⊕G026) BRP (⊕K190) DCCC (⊕K200) Oprawka typu AL (⊕C034) AHX640S (⊕K041)
	CS250T	3.7	M2.5×0.45	6	1.8	2.4	90°	T8	1.0	
	* CS250560T	3.9	M2.5×0.45	5.2	2.5	2.4	60°	T8	1.0	
	CS300590T	4.1	M3×0.5	5.5	2.1	2.4	90°	T8	1.0	
	CS300790TS	4.7	M3×0.5	7	2.3	2.8	90°	T10	2.0	
	CS300890T	4.1	M3×0.5	8	2.1	2.4	90°	T8	1.0	
	CS350690T	4.8	M3.5×0.6	6.5	2.4	2.8	90°	T10	2.5	
	* CS350760T	5.5	M3.5×0.6	7	4.0	3.4	60°	T15	3.5	
	CS350790T	4.8	M3.5×0.6	7	2.4	2.8	90°	T10	3.5	
	* CS350860T	5.5	M3.5×0.6	8.4	4.0	3.4	60°	T15	3.5	
	CS350990T	4.8	M3.5×0.6	9	2.4	2.8	90°	T10	2.5	
	CS400990T	6.0	M4×0.7	9	2.8	3.4	90°	T15	3.5	
	CS401160T	5.7	M4×0.7	11	4.5	3.4	60°	T15	3.5	
	CS401990T	6.0	M4×0.7	19	3.0	3.9	90°	T20	3.5	
	CS451190T	6.3	M4.5×0.75	11	2.9	3.9	90°	T20	5.0	
	* CS501160T	7.0	M5×0.8	11	3.6	3.9	60°	T20	5.0	
CS501290T	7.0	M5×0.8	11	3.5	4.5	90°	T25	7.5		
* CS5015060T	7.2	M5×0.8	15	2.4	3.9	60°	T20	5.0		
CS502190T	8.5	M5×0.8	21	4.0	5.1	90°	T27	7.5		
CS6016060T	8.5	M6×1.0	16	4.5	4.5	60°	T25	7.5		
	CSF401260T	7.2	M4×0.5	12	5.2	3.9	60°	T20	5.0	PMR (⊕K236)
	DC0520T	8.5	M5×0.8	22.5	2.5	3.4	—	T15	3.5	Oprawka Z PODWÓJNYM SYSTEMEM MOCOWANIA (⊕C008) OPRAWKA "DIMPLE BAR" Z PODWÓJNYM SYSTEMEM MOCOWANIA (⊕E015) Nazwa oprawki HSK (⊕H001)
	DC0621T	10.5	M6×1.0	25	4	3.9	—	T20	5.0	
	DKS4	5.6	M4×0.7	18	3.5	3	—	—	3.3	
	DKS5	7.6	M5×0.8	19	4.5	4	—	—	7.0	

N

CZĘŚCI ZAPASOWE

CZĘŚCI ZAPASOWE

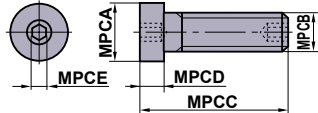
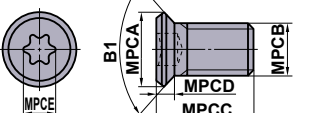
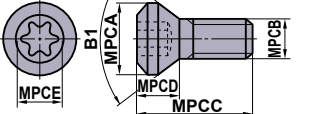
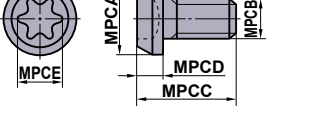
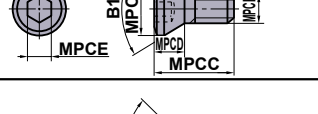
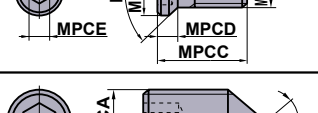
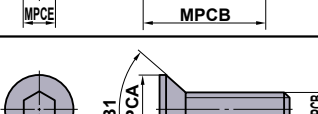
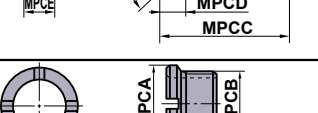
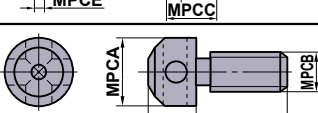
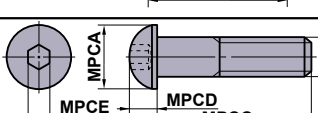
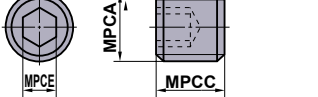
WKRĘT DOCISKOWY



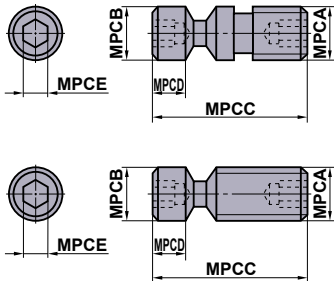
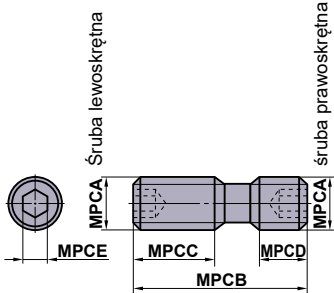
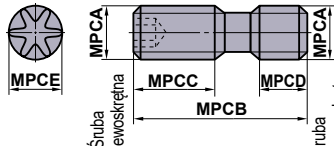
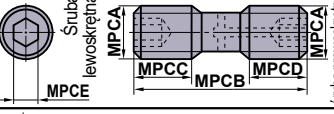
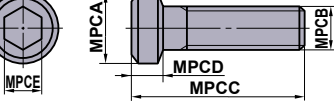
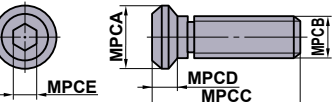

Geometria	Numer zamówieniowy	Wymiary (mm)					Kąt		TQ (N·m)	Nazwa oprawki
		MPCA	MPCB	MPCC	MPCD	MPCE	B1	MPCDS		
	EGS06019	9	M6×1	22.5	3.5	3	—	—	3.3	
	EGS08024	11	M8×1.25	28.5	4.5	4	—	—	7.0	
	FC400890T	5.6	M4×0.7	7.5	1.3	2.8	90°	T10	2.5	Oprawka typu AL (⊕C035) Oprawki wytaczarskie typu AL (⊕E041)
	GY05016S	8.7	M5×0.8	16	3.5	3.9	90°	T20	5.0	Oprawki serii GY (⊕F004)
	GY06013M	12	M6×1	18	5	5.6	—	T30	6.0	Oprawki serii GY (⊕F004)
	HFF06015	10	M6×1	15	6	5	80°	—	8.2	
	HS4L	5.4	M4×0.7	14	2.3	2.5	80°	—	3.8	
	HS5S	6.8	M5×0.8	9	2.8	3	80°	—	3.3	
	HS5L	6.8	M5×0.8	15	2.8	3	80°	—	6.6	
	HSP05008C	M5×0.8	8	—	—	2.5	—	—	2.5	Oprawka typu MP (⊕C019)
	HY-A1	4.4	M3×0.5	7	2.1	2	82°	—	1.5	
	HY-V1	5.5	M3×0.5	7	2.5	2	82°	—	1.5	
	HY2	5.5	M3×0.5	10	2.5	2	82°	—	1.5	
	HY3	7	M3.5×0.6	12	2.9	2	82°	—	1.5	
	HY4	9.3	M5×0.8	16	3.6	3	82°	—	3.3	
	JSS6	6.9	M6×0.75	4.5	1.5	0.8	—	—	—	
	JSS7	8	M7×0.75	4.4	1.5	1	—	—	—	
	KS1	7	M4×0.7	14	5	—	—	—	—	
	KS2	10	M6×1	18	7	—	—	—	—	
	KS2S	10	M6×1	18	7	—	—	—	—	
	KS12	10	M6×1	26	4	4	—	—	7.0	
	LLR1	M5×0.8	—	3.5	—	2.5	—	—	—	
	LLR2	M6×1	—	5	—	3	—	—	—	

Geometria	Numer zamówieniowy	Wymiary (mm)					Kąt B1	MPCDS	TQ (N·m)	Nazwa oprawki
		MPCA	MPCB	MPCC	MPCD	MPCE				
 <p>LLCS103, LLCS105 LLCS112, LLCS125 LLCS205</p> <p>Produkty oznaczone "*" nie posiadają otworu od strony oznaczonej literą "MPCB".</p> <p>Produkty oznaczone "☆" nie posiadają otworu od strony oznaczonej literą "MPCA".</p>	☆ LLCS103	M3×0.5	4	11	4.6	2	—	—	1.5	Oprawki wytaczarskie typu P (⊕E037) Nazwa oprawki HSK (⊕H001)
	* LLCS105	M5×0.8	M5×0.8	10	1.5	2	—	—	1.5	
	LLCS106	M6×1	6	16.5	3.5	2.5	—	—	2.2	
	* LLCS106S	M6×1	6	13.4	0.7	2.5	—	—	2.2	
	LLCS108	M8×1.25	8	21	6.5	3	—	—	3.3	
	* LLCS108S	M8×1.25	8	16.5	2	3	—	—	3.3	
	LLCS110	M10×1.5	10	29	8	4	—	—	7.0	
	LLCS112	M12×1	11.9	36.2	9	5	—	—	8.0	
	LLCS125	M5×0.8	M5×0.8	12	2	2	—	—	1.5	
	LLCS205	M5×0.8	M5×0.8	16	4	2	—	—	1.5	
	LLCS206	M6×1	6	26	13	2.5	—	—	2.2	
	LLCS208	M8×1.25	8	24	6.5	3	—	—	3.3	
	LLCS306	M6×1	6	21	4	2.5	—	—	2.2	
	LLCS308	M8×1.25	8	42	27.5	3	—	—	3.3	
	LLCS310	M10×1	10	29	8	4	—	—	7.0	
	LLCS410	M10×1	10	30	6.6	4	—	—	7.0	
	LLCS508	M8×1	8	24	6.5	3	—	—	3.3	
* LLCS508S	M8×1	8	20.5	3	3	—	—	3.3		
 <p>Śruba lewoskrętna</p> <p>Śruba prawoskrętna</p> <p>* Nie posiada sześciokątnego gniazda na prawoskrętnej śrubie</p>	LS1	M6×1	22	8	8	3	—	—	5.0	Narzędzia do frezowania (⊕K001)
	LS2	M8×1	29	13	10	4	—	—	8.2	
	LS3	M8×1	32	13	13	4	—	—	8.2	
	* LS4	M6×1	15	8	4	3	—	—	5.0	
	* LS5	M6×1	18	8	5	3	—	—	5.0	
	* LS6	M8×1	24	13	5	4	—	—	8.2	
	* LS7	M8×1	27	13	8	4	—	—	8.2	
	* LS8	M6×0.75	18	7	7	3	—	—	5.0	
	* LS9	M6×0.75	22	8	8	3	—	—	5.0	
	* LS10	M7×0.75	16	6	6	4	—	—	8.2	
	* LS11	M8×1	16	6	6	4	—	—	7.8	
	* LS12	M8×1	24	7	7	4	—	—	7.8	
	* LS13	M8×1	34	12	12	4	—	—	7.8	
	* LS14	M7×0.75	24	10	10	4	—	—	7.8	
	* LS16	M7×0.75	23	11	8	4	—	—	7.8	
* LS18	M7×0.75	14	6	4	4	—	—	7.8		
* LS20	M10×1.5	26	9	9	5	—	—	9.0		
* LS21	M10×1.5	32	12	12	5	—	—	9.0		
 <p>Śruba lewoskrętna</p> <p>Śruba prawoskrętna</p>	LS24	M8×1.25	24	8.5	8.5	4	—	—	7.8	Oprawka Z PODWÓJNYM SYSTEMEM MOCOWANIA (⊕C009)
	LS25	M8×1	28.5	12.0	10.5	4	—	—	8.2	
	LS10T	M7×0.75	14	6	5	4.5	—	T25	8.0	
	LS14T	M7×0.75	24	10	10	4.5	—	T25	8.0	
	LS15T	M7×0.75	18	7	7	4.5	—	T25	8.0	
	LS19T	M6×0.75	11	4	4	3.4	—	T15	5.0	
	LS10TS	M7×0.75	13	6	4	4.5	—	T25	8.5	
LS0622T	M6×0.75	22	8	8	3.4	—	T15	6.0		
 <p>Śruba lewoskrętna</p> <p>Śruba prawoskrętna</p>	LS24H	M8×1.25	24	8.5	8.5	4	—	—	8.2	AHX640W (⊕K048)
	MGS6	10	M6×1	26	4	5	—	—	9.0	APX3000 (⊕K133)
	MHT1	11	M8×1	18.5	3.5	4	—	—	8.7	

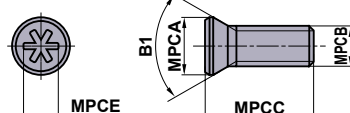
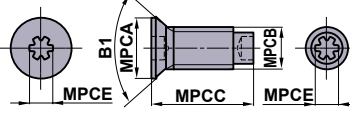
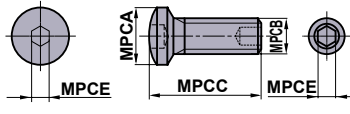
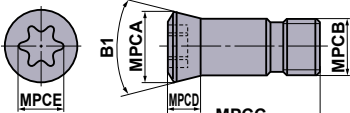
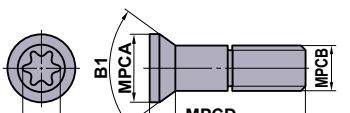
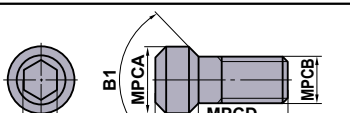
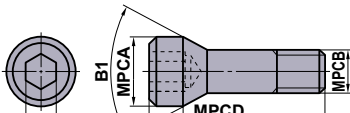
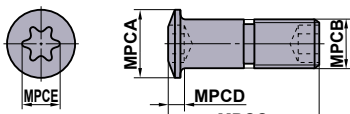
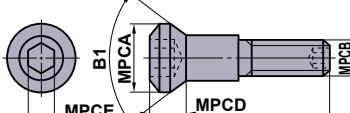
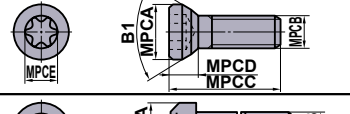
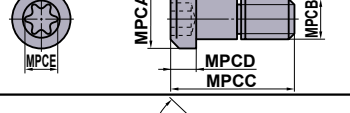
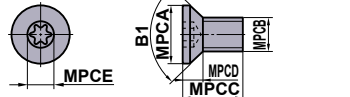
CZĘŚCI ZAPASOWE

WKRĘT DOCISKOWY

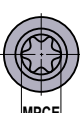
Geometria	Numer zamówieniowy	Wymiary (mm)					Kąt B1	MPCDS	TQ (N·m)	Nazwa oprawki
		MPCA	MPCB	MPCC	MPCD	MPCE				
	NS251	3.6	M2.5×0.45	7	—	2.2	60°	—	0.7	BTVH (⊕D016) CSVH (⊕D027) CTAH-S (⊕D020)
	NS401	5.8	M4×0.7	6	—	3.6	60°	—	3.5	
	NS402W	5.85	M4×0.7	10	—	2.2	60°	—	0.7	CTAH (⊕D020) CTBH (⊕D022)
	NS403W	5.85	M4×0.7	12	—	2.2	60°	—	0.7	
	NS404W	5.8	M4×0.7	10	—	2.2	90°	—	0.7	
	NS501W	8	M5×0.8	16	—	2.5	120°	—	2.2	MIKRONARZĘDZIA (⊕D001)
	NS502W	8	M5×0.8	20	—	2.5	120°	—	2.2	
	RN-S6	9.5	M6×0.75	20.3	4.6	3.9	61°	T20	5.0	
	RN-S7	11	M7×0.75	24.7	5.2	4.5	61°	T25	7.5	
	RS3008T	4.3	M3×0.35	8.6	2	2.4	61°	T8	1.5	SRF (⊕K212) SUF (⊕K216)
	RS3510T	5	M3.5×0.35	10	2.3	2.8	61°	T10	2.5	
	RS4015T	6	M4×0.5	14	2.7	3.4	61°	T15	3.3	
	RS5020T	8.1	M5×0.5	16.4	3.6	3.9	61°	T20	5.0	
	RS6025T	9.5	M6×0.75	21.5	4.2	4.5	61°	T25	7.5	
	RS8030T	12	M8×0.75	25	5	5.6	61°	T30	10.0	
	S1	3.5	M2×0.4	5.5	2.2	1.5	92°	—	0.6	
	S3	4.5	M3×0.5	7.7	2.4	2	92°	—	1.5	
	S4	5.3	M4×0.7	8	1.8	2.5	62°	—	2.2	
	S5	6.8	M5×0.8	9	2.4	3	62°	—	3.3	
	SD32	12	M8×1.25	28	7.2	6	50°	—	9.5	
	SD40	12	M8×1.25	36	7.2	6	50°	—	9.5	
	SD50	16	M10×1.5	46	8.2	8	50°	—	1.0	
	SD63	16	M10×1.5	61	8.2	8	50°	—	1.0	
	SETS51	6.8	M5×0.8	14.8	1.5	3.4	—	T15	3.5	Oprawka typu MMTE (⊕G019)
	SETS61	8	M6×1	20	1.8	3.9	—	T20	5.0	Oprawki wytaczarskie typu MMTI (⊕G026) Nazwa oprawki HSK (⊕H001)
	SLCS105	10	M5×0.8	25	6.3	4	90°	—	7.0	Oprawka typu WP (⊕C017)
	SLCS106	12	M6×1	32	6.2	4	90°	—	7.0	
	SPS1	8.5	M5×0.8	16	4	4.5	70°	T25	5.0	
	SRS5	6.7	M5×0.8	16	3.5	3.9	—	T20	5.0	
	STS1	6.8	M3×0.5	7	2.2	2.8	90°	T10	2.5	

Geometria	Numer zamówieniowy	Wymiary (mm)					Kąt B1	MPCDS	TQ (N·m)	Nazwa oprawki
		MPCA	MPCB	MPCC	MPCD	MPCE				
	* TS16	2.5	M1.6×0.35	3.2	1.6	1.8	60°	T6	0.6	MICRO-DEX (☉E018)
	TS2	2.7	M2×0.4	4.6	1.4	1.8	60°	T6	0.6	
	* TS2A	2.7	M2×0.4	4.5	1.2	1.8	60°	T6	0.6	AQX (☉K172)
	TS2C	2.7	M2×0.4	3.8	1.4	1.8	60°	T6	0.6	
	☆ TS2D	3.8	M2×0.4	5.3	1.9	1.8	82°	T6	0.6	DIMPLE BAR (☉E007)
	TS21	2.7	M2×0.4	3.4	1.4	1.8	60°	T6	0.6	Oprawki wytaczarskie typu F (☉E029)
	* TS22	3.0	M2.2×0.45	5	1.2	1.8	60°	T6	0.6	Oprawki wytaczarskie typu S (☉E030)
	* TS25	3.3	M2.5×0.45	5.5	1.7	2.4	60°	T8	1.0	AQX (☉K172) AJX (☉K180)
	☆ TS25D	4.4	M2.5×0.45	6.2	2.2	2.4	82°	T8	1.0	Oprawki wytaczarskie typu MMTI (☉G026)
	* TS25H	3.6	M2.5×0.45	5.5	2	2.4	60°	T8	1.0	SRM2 (☉K220)
	TS202	2.7	M2×0.4	5.5	1.8	1.8	60°	T6	0.6	
	TS253	3.3	M2.5×0.45	4.5	1.7	2.4	60°	T8	1.0	Narzędzia do frezowania (☉K001)
	TS254	3.3	M2.5×0.45	7	1.7	2.4	60°	T8	1.0	MIKRONARZĘDZIA (☉D001) PMF (☉K234)
	* TS255	3.5	M2.5×0.45	7.5	1.6	2.4	60°	T8	1.0	Oprawka Profil (☉C032)
	TS3	3.9	M3×0.5	6	2	2.4	60°	T8	1.0	TSMP (☉K232)
	TS304	3.9	M3×0.5	10.5	2.0	2.4	60°	T8	1.5	
	TS3D	5.0	M3×0.5	6	2.3	2.8	82°	T10	2.5	DIMPLE BAR (☉E007)
	* TS3SB	4.4	M3×0.5	8	2	2.4	80°	T8	1.5	AXD4000 (☉K155)
	TS3SBS	4.4	M3×0.5	6.5	2	2.4	80°	T8	1.5	AXD4000 (☉K155)
	☆ TS31D	4.8	M3×0.5	7.2	2.2	2.8	82°	T10	2.5	DIMPLE BAR (☉E007)
	* TS32	3.9	M3×0.5	7.5	2	2.4	60°	T8	2.0	SRM2 (☉K220)
	* TS33	3.9	M3×0.5	6.7	2	2.4	60°	T8	1.5	AQX (☉K172) AJX (☉K180)
	TS35	4.8	M3.5×0.6	6.5	2.4	2.8	60°	T10	2.5	
	* TS35D	5.3	M3.5×0.6	12	2.8	3.4	60°	T15	3.5	Nazwa oprawki HSK (☉H001)
	★ TS35R	5.7	M3.5×0.6	10	2.1	3.4	—	T15	3.5	AHX440S (☉K034) AHX475S (☉K038)
	TS351	4.8	M3.5×0.6	7.2	2.4	2.8	60°	T10	2.5	AJX (☉K180) SRM2 (☉K220)
	TS352	4.8	M3.5×0.6	10	3	2.8	60°	T10	2.5	VFX5 (☉K192)
	TS4S	5.4	M4×0.7	7	2.4	3.4	80°	T15	3.5	
	* TS4SL	5.4	M4×0.7	8	2.4	3.4	80°	T15	4.0	
	* TS4SB	5.8	M4×0.7	9	2.7	3.4	80°	T15	3.5	AXD7000 (☉K166)
	* TS4SBL	5.8	M4×0.7	10.5	2.7	3.4	80°	T15	3.5	Oprawki serii GY (☉F004) AXD7000 (☉K166)
	TS4	5.4	M4×0.7	8	2.6	3.4	60°	T15	3.5	CE/CF/CGSP (☉K230) TSMP (☉K232)
	TS4D	5.6	M4×0.7	7.7	2.5	3.4	82°	T15	3.5	DIMPLE BAR (☉E007)
	TS42	5.4	M4×0.7	6	2.6	3.4	60°	T15	3.5	
	TS43	5.4	M4×0.7	10	2.6	3.4	60°	T15	3.5	AJX (☉K180) BRP (☉K190) SRM2 (☉K220)
	TS44	5.4	M4×0.7	12	2.6	3.4	60°	T15	3.5	
	TS406	5.4	M4×0.7	15.5	2.6	3.4	60°	T15	3.5	
	TS407	5.4	M4×0.7	9	2.6	3.4	60°	T15	3.5	AQX (☉K172) AJX (☉K180)
	TS450	5.9	M4.5×0.75	13	3.6	3.9	60°	T20	5.0	VFX6 (☉K196)
	TS5S	6.8	M5×0.8	9	2.9	4.5	80°	T25	7.5	
	* TS5SL	6.8	M5×0.8	12	2.9	4.5	80°	T25	7.5	
	TS5	6.8	M5×0.8	9	3.2	4.5	60°	T25	7.5	Oprawka SP (☉C024) CE/CF/CGSP (☉K230) TSMP (☉K232)
	TS5L	6.8	M5×0.8	15	2.9	4.5	80°	T25	7.5	
	★ TS5R	6.9	M5×0.8	12	3.5	3.9	—	T20	5.0	WWX400 (☉K056) WJX (☉K072)
	TS52	6.8	M5×0.8	8	3.2	4.5	60°	T25	7.5	CE/CF/CGSP (☉K230)
	TS53	6.8	M5×0.8	16	3.2	4.5	60°	T25	7.5	
	TS54	6.8	M5×0.8	12	3.2	4.5	60°	T25	7.5	AJX (☉K180)
	TS55	6.8	M5×0.8	10.5	3.2	4.5	60°	T25	7.5	Oprawki serii GY (☉F004) AQX (☉K172) SPX (☉K203) SRM2 (☉K220)
	* TS6S	8.5	M6×1.0	13	4.4	5.6	60°	T30	10.0	AQX (☉K172) SRM2 (☉K220)
	* TS6	8.5	M6×1.0	16	4.4	5.6	60°	T30	10.0	SRM2 (☉K220)

N

CZĘŚCI ZAPASOWE

CZĘŚCI ZAPASOWE

WKREŃ DOCISKOWY

CZĘŚCI ZAPASOWE

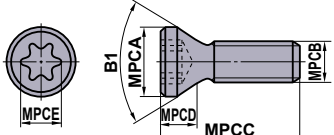
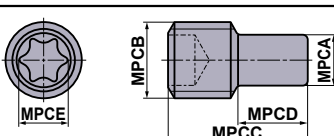
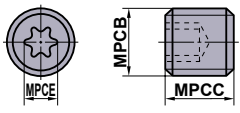
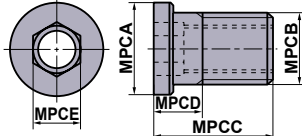
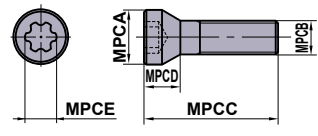
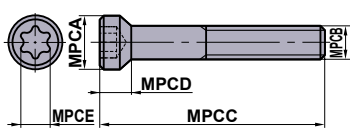
Geometria	Numer zamówieniowy	Wymiary (mm)					Kąt B1	MPCDS	TQ (N·m)	Nazwa oprawki
		MPCA	MPCB	MPCD	MPCD	MPCD				
	TPS20	2.7	M2×0.4	3.5	1.3	1.8	60°	6IP	0.5	
	TPS20-1	2.65	M2×0.4	4.7	2.4	1.8	60°	6IP	0.6	MVX (⊕M160)
	TPS22	3.0	M2.2×0.45	4.7	1.6	2.1	60°	7IP	0.5	
	TPS22S	3.0	M2.2×0.45	4.2	1.6	2.1	60°	7IP	0.5	
	TPS25	3.3	M2.5×0.45	5.5	1.7	2.1	60°	7IP	1.0	APX3000 (⊕K133) MVX (⊕M160)
	TPS25-1	3.3	M2.5×0.45	6.5	1.7	2.1	60°	7IP	1.0	APX3000 (⊕K133)
	TPS27F1	3.7	M2.7×0.35	6.5	1.8	2.1	60°	7IP	1.0	VPX200 (⊕K086)
	TPS27F2	3.7	M2.7×0.35	8.0	1.8	2.1	60°	7IP	1.0	VPX300 (⊕K100)
	TPS3	3.9	M3×0.5	6.7	1.4	2.82	60°	10IP	1.0	MVX (⊕M160)
	* TPS3R	4.6	M3×0.5	8.5	1.4	2.82	—	10IP	2.0	WJX09 (⊕K072)
	TPS3SB	4.4	M3×0.5	8	2.0	2.82	80°	10IP	3.0	AXD4000A (⊕K162)
	TPS35	5.3	M3.5×0.6	11.5	2.8	3.4	60°	15IP	3.5	ASX445 (⊕K026) ASX400 (⊕K068) PMR (⊕K236)
	TPS351	4.8	M3.5×0.6	7.2	1.4	2.82	60°	10IP	2.5	MVX (⊕M160)
	TPS351B	5.1	M3.5×0.6	7.2	1.4	2.82	60°	10IP	2.5	ARP (⊕K238)
	TPS4	5.3	M4×0.7	8	2.6	3.4	60°	15IP	3.5	APX4000 (⊕K140) ARP (⊕K238) MVX (⊕M160)
	TPS40F1	5.3	M4×0.5	10.5	2.8	3.4	60°	15IP	3.0	VPX300 (⊕K100)
TPS43	5.3	M4×0.7	10	2.6	3.4	60°	15IP	4.0	APX4000 (⊕K140) MVX (⊕M160)	
* TPS4R	6.4	M4×0.7	10.6	2.9	3.4	—	15IP	3.5	WSX445 (⊕K016)	
TPS54	6.8	M5×0.8	12	3.2	4.5	60°	25IP	7.5	MVX (⊕M160)	
	TSR05008S	3.5	M5×0.8	8	—	2.8	—	T10	—	
	TSR06011S	4	M6×1.0	11	—	3.9	—	T20	—	
	TSS04005	—	M4×0.7	5	—	2.4	—	T8	—	PMF (⊕K234)
	TSS04505S	—	M4.5×0.7	5	—	3.5	—	T10	3.5	FMAX (⊕K051)
	TSS05006	—	M5×0.8	6	—	2.8	—	T10	—	
	TSS06010	—	M6×1	10	—	3.9	—	T20	—	
	WCS503507H	6.3	M5×0.5	7	3.3	3.5	—	—	5.0	ASX445 (⊕K026) ASX400 (⊕K068) PMR (⊕K236)
	WCS604010H	7.8	M6×0.75	10	4.1	4.0	—	—	7.0	PMR (⊕K236)
	WS203107TPS	3.1	M2×0.25	7.3	1.7	1.8	60°	6IP	1.0	STAW (⊕M141)
	WS203108TPS	3.1	M2×0.25	8.3	1.9	1.8	60°	6IP	1.0	
	WS253909TPS	3.9	M2.5×0.35	9.5	2.4	2.4	60°	8IP	2.0	
	WS304912TPS	4.9	M3×0.35	12	3.25	2.82	60°	10IP	2.5	
	WS254012T	4	M2.5×0.45	11.5	2.2	2.4	80°	T8	2.0	TAW (⊕M150)
	WS254013T	4	M2.5×0.45	12.5	2.2	2.4	80°	T8	2.0	
	WS254014T	4	M2.5×0.45	13.5	2.2	2.4	80°	T8	2.0	
	WS254015T	4	M2.5×0.45	14.5	2.2	2.4	80°	T8	2.0	
	WS254016T	4	M2.5×0.45	15.5	2.2	2.4	80°	T8	2.0	
	WS304517T	4.5	M3×0.5	16.5	3.4	2.8	60°	T10	3.5	
	WS304518T	4.5	M3×0.5	17.5	3.4	2.8	60°	T10	3.5	
	WS355520T	5.5	M3.5×0.6	19.5	3.9	3.4	60°	T15	5.5	
	WS355521T	5.5	M3.5×0.6	20.5	3.9	3.4	60°	T15	5.5	
	WS406023T	6	M4×0.7	22.0	4.4	4.5	60°	T25	8.5	
	WS406024T	6	M4×0.7	23.0	4.4	4.5	60°	T25	8.5	
	WS508026T	8	M5×0.8	25.0	5.2	5.1	60°	T27	12.0	
WS508027T	8	M5×0.8	26.0	5.2	5.1	60°	T27	12.0		

ŚRUBA USTALAJĄCA

Geometria	Numer zamówieniowy	Wymiary (mm)						Kąt B1	MPCDS	TQ (N·m)	Nazwa oprawki
		MPCA	MPCB	MPCC	MPCD	MPCE	MPCF				
	BOES101	15	M10×1.5	45	10	8	60°	—	10.0		
	* HSC08025H	13	M8×1.25	33	8	5	—	—	24	VPX200/300 (⊕K086,K100) ARP (⊕K238)	
	HSC05030	8.5	M5×0.8	35	5	4	—	—	10	APX3000/4000 (⊕K133,K140)	
	* HSC08030H	13	M8×1.25	38	8	5	—	—	24	WSX445 (⊕K016)	
	HSC08045	13	M8×1.25	53	8	5	—	—	24	VPX200/300 (⊕K086,K100)	
	HSC08040	13	M8×1.25	48	8	5	—	—	24	WSX445 (⊕K016)	
	HSC08050	13	M8×1.25	58	8	5	—	—	24	VPX200/300 (⊕K086,K100)	
	* HSC10030H	16	M10×1.5	40	10	6	—	—	40	APX3000/4000 (⊕K133,K140) AJX (⊕K180) WSX445 (⊕K016)	
	HSC10035	16	M10×1.5	45	10	6	—	—	44	VFX5 (⊕K192) VFX6 (⊕K196)	
	HSC10050	16	M10×1.5	60	10	8	—	—	44	APX3000/4000 (⊕K133,K140) VPX200/300 (⊕K086,K100)	
	HSC10055	16	M10×1.5	65	10	8	—	—	44	VFX5 (⊕K192)	
	HSC10060	16	M10×1.5	70	10	8	—	—	44	VPX200/300 (⊕K086,K100)	
	HSC10070	16	M10×1.5	80	10	8	—	—	44	VPX200/300 (⊕K086,K100) ASPX (⊕K028)	
	HSC12035	18	M12×1.75	47	12	10	—	—	80	WSX445 (⊕K016)	
	* HSC12035H	18	M12×1.75	47	12	10	—	—	80	APX3000/4000 (⊕K133,K140) AJX (⊕K180)	
	HSC12040	18	M12×1.75	52	12	10	—	—	80		
	HSC12045	18	M12×1.75	57	12	10	—	—	80	WSX445 (⊕K016)	
	HSC12060	18	M12×1.75	72	12	10	—	—	80	VPX200/300 (⊕K086,K100)	
	HSC12070	18	M12×1.75	82	12	10	—	—	80	APX3000/4000 (⊕K133,K140) AJX (⊕K180) WSX445 (⊕K016)	
	HSC16040	24	M16×2	56	16	14	—	—	150	WSX445 (⊕K016)	
	* HSC16040H	24	M16×2	56	16	14	—	—	150	APX3000/4000 (⊕K133,K140) AJX (⊕K180)	
HSC16055	24	M16×2	71	16	14	—	—	150	VPX200/300 (⊕K086,K100)		
HSC16065	24	M16×2	81	16	14	—	—	150	VPX200/300 (⊕K086,K100)		
HSC16080	24	M16×2	96	16	14	—	—	150			
* Z kanałem doprowadzającym chłodziwo.	HSC20040	30	M20×2.5	60	20	17	—	—	320		
HSC20090	30	M20×2.5	110	20	17	—	—	320			
	HSCX12030H	24	M12×1.75	37	7	8	—	—	40	FMAX (⊕K051)	
	HSCX16035H	30	M16×2	44	9	12	—	—	100		
	HSCX20035H	36	M20×2.5	46	11	14	—	—	180		
	HFF08033H	11	M8×1.25	33	5	5	90°	—	8.2	WJX09 (⊕K072)	
	HFF08043H	11	M8×1.25	43	5	5	90°	—	8.2	AXD4000 (⊕K155)	
	MBA16033H	40	M16×2	43	10	14	—	—	150	AHX640 (do φ100) (⊕K041) WSX445 (⊕K016)	
	MBA20040H	50	M20×2.5	54	14	17	—	—	320	APX4000 (⊕K140) AHX475S (⊕K038) AHX640S (⊕K041) AXD4000 (⊕K155) AXD7000 (⊕K166) AJX (⊕K180)	

Geometria	Numer zamówieniowy	Wymiary (mm)						TQ (N·m)	Nazwa oprawki
		MPCA	MPCB	MPCC	MPCD	MPCE	MPCF		
	HDS08030	M8×0.75	M8×1.25	30	13.5	11.5	4	8.2	BRP (⊕K190)
	HDS10031	M10×1.0	M10×1.5	31	14	12	5	9.0	PMF (⊕K234)

N
CZĘŚCI ZAPASOWE

CZĘŚCI ZAPASOWE

ŚRUBA DO REGULACJI ZGRUBNEJ

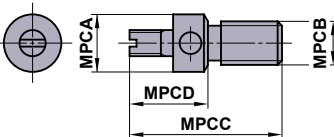
Geometria	Numer zamówieniowy	Wymiary (mm)					Kąt	MPCCS	TQ (N·m)	Nazwa oprawki
		MPCA	MPCB	MPCC	MPCD	MPCE	B1			
	KSS2	6.6	M5×0.8	17.5	9	—	—	—	FMAX (K051)	

N

CZĘŚCI ZAPASOWE

NAKRĘTKA DO MIKROREGULACJI

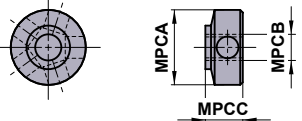
Geometria	Numer zamówieniowy	Wymiary (mm)					Kąt	MPCCS	TQ (N·m)	Nazwa oprawki
		MPCA	MPCB	MPCC	MPCD	MPCE	B1			
	KSN3	8.6	M3×0.35	4.3	—	—	—	—	FMAX (K051)	

PŁYTKA PODPOROWA

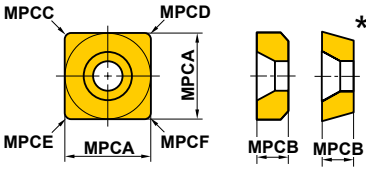
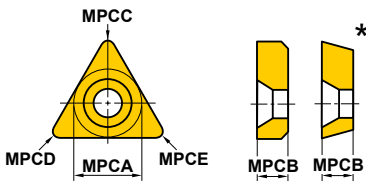
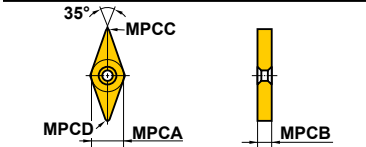
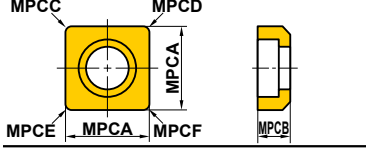
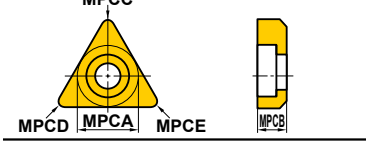
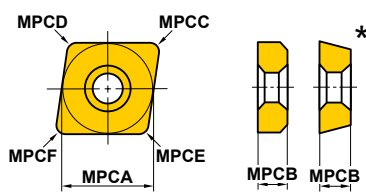
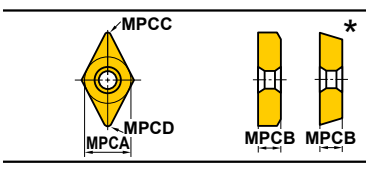
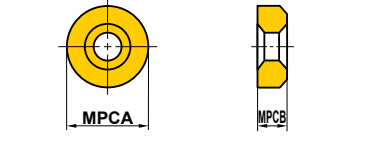
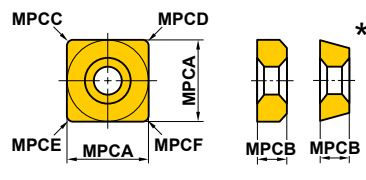
Geometria	Numer zamówieniowy	Wymiary (mm)						Nazwa oprawki
		MPCA	MPCB	MPCC	MPCD	MPCE	MPCF	
	CS32	9.52	3.18	0.8	0.8	1.2	1.2	
	CS42	12.70	3.18	0.8	0.8	1.2	1.6	
	CS43	12.70	4.76	0.8	0.8	1.2	1.6	
	* PS31	8.28	2.38	0.2	0.2	0.6	0.6	
	* PS42	11.46	3.18	0.2	0.2	0.6	1.0	
	CT22	6.35	3.18	0.4	0.8	1.2	—	
	CT32	9.52	3.18	0.4	0.8	1.2	—	
	* PT21	5.11	2.38	0.2	0.2	0.6	—	
	* PT32	8.28	3.18	0.2	0.2	0.6	—	Oprawki wytaczarskie typu F (☉E028)
	* PT42	10.85	3.18	0.3	0.3	0.7	—	
BPT322	7.8	3.18	—	—	—	—		
	DCSVN32	9.52	3.18	0.8	1.2	—	—	Oprawka Z PODWÓJNYM SYSTEMEM MOCOWANIA (☉C019) OPRAWKA "DIMPLE BAR" Z PODWÓJNYM SYSTEMEM MOCOWANIA (☉E017)
	ESS42	12.70	3.18	0.8	0.8	1.2	1.6	
	EST32	9.52	3.18	0.4	0.8	1.2	—	
EST43	12.70	4.76	0.4	0.8	1.2	—		
	LLSCN3T3	9.52	3.97	0.4	0.4	0.8	0.8	Oprawka typu LL (☉C008)
	LLSCN33	9.52	4.76	0.4	0.4	0.8	0.8	Oprawka typu LL (☉C008)
	LLSCN42	12.70	3.18	0.8	0.8	1.2	1.2	OPRAWKA "DIMPLE BAR" Z PODWÓJNYM SYSTEMEM MOCOWANIA (☉E015)
	LLSCN53	15.87	4.76	1.2	1.2	1.6	1.6	Oprawki wytaczarskie typu P (☉E038)
	LLSCN63	19.05	4.76	1.2	1.2	1.6	1.6	Nazwa oprawki HSK (☉H001)
	* LLSCP42	12.70	3.18	0.8	0.8	1.2	1.2	OPRAWKA "DIMPLE BAR" Z PODWÓJNYM SYSTEMEM MOCOWANIA (☉E015)
* LLSCP63	19.05	4.76	1.2	1.2	1.6	1.6	Oprawki wytaczarskie typu P (☉E038) Nazwa oprawki HSK (☉H001)	
	LLSDN32	9.52	3.18	0.8	1.2	—	—	Oprawka Z PODWÓJNYM SYSTEMEM MOCOWANIA (☉C010)
	LLSDN42	12.70	3.18	0.8	1.2	—	—	Oprawka typu LL (☉C010)
	LLSDN43	12.70	4.76	0.8	1.2	—	—	OPRAWKA "DIMPLE BAR" Z PODWÓJNYM SYSTEMEM MOCOWANIA (☉E015)
	LLSDN53	15.87	4.76	1.2	1.6	—	—	Oprawki wytaczarskie typu P (☉E038)
	* LLSDP42	12.70	3.18	0.8	1.2	—	—	Nazwa oprawki HSK (☉H001) OPRAWKA "DIMPLE BAR" Z PODWÓJNYM SYSTEMEM MOCOWANIA (☉E015)
	LLSRN103	8.3	3.18	—	—	—	—	Oprawka typu LL (☉C026)
	LLSRN123	9.8	3.18	—	—	—	—	Nazwa oprawki HSK (☉H001)
	LLSRN164	13.6	4.76	—	—	—	—	
	LLSRN204	17.3	4.76	—	—	—	—	
	LLSRN256	22.0	6.35	—	—	—	—	
	LLSRN326	28.0	6.35	—	—	—	—	
	LLSSN32	9.52	3.18	0.8	0.8	1.2	1.2	
	LLSSN33	9.52	4.76	0.8	0.8	1.2	1.2	OPRAWKA "DIMPLE BAR" Z PODWÓJNYM SYSTEMEM MOCOWANIA (☉E016)
	LLSSN42	12.70	3.18	0.8	0.8	1.2	1.6	Oprawki wytaczarskie typu P (☉E037)
	LLSSN53	15.87	4.76	1.2	1.2	1.6	1.6	
	LLSSN63	19.05	4.76	1.2	1.2	1.6	2.0	
	LLSSN84	25.40	6.35	1.6	1.6	2.4	2.4	
	* LLSSP42	12.70	3.18	0.8	0.8	1.2	1.6	OPRAWKA "DIMPLE BAR" Z PODWÓJNYM SYSTEMEM MOCOWANIA (☉E016)

N

CZĘŚCI ZAPASOWE

CZĘŚCI ZAPASOWE

PŁYTKA PODPOROWA

N

CZĘŚCI ZAPASOWE

Geometria	Numer zamówieniowy	Wymiary (mm)						Nazwa oprawki
		MPCA	MPCB	MPCC	MPCD	MPCE	MPCF	
	LLSTE32	7.6	3.18	0.4	0.4	0.4	—	Oprawka typu LL (☉C016) OPRAWKA "DIMPLE BAR" Z PODWÓJNYM SYSTEMEM MOCOWANIA (☉E016) Oprawki wytaczarskie typu P (☉E037)
	LLSTN32	9.52	3.18	0.4	0.8	1.2	—	
	LLSTN33	9.52	4.76	0.4	0.8	1.2	—	
	LLSTN42	12.70	3.18	0.4	0.8	1.2	—	
	LLSTN53	15.87	4.76	0.8	1.2	1.6	—	
	* LLSTP32	9.52	3.18	0.4	0.8	1.2	—	
* LLSTP42	12.70	3.18	0.4	0.8	1.2	—		
	LLSWN32	9.52	3.18	0.4	0.8	1.2	—	Oprawka typu LL (☉C022) Oprawka Z PODWÓJNYM SYSTEMEM MOCOWANIA (☉C022) OPRAWKA "DIMPLE BAR" Z PODWÓJNYM SYSTEMEM MOCOWANIA (☉E017)
	LLSWN3T3	9.52	3.97	0.4	0.8	1.2	—	
	LLSWN42	12.70	3.18	0.4	0.8	1.2	—	
	* LLSWP32	9.52	3.18	0.4	0.8	1.2	—	
	* LLSWP42	12.70	3.18	0.4	0.8	1.2	—	
	MHS532R/L	9.4	15.7	4.5	0.8	0.8	—	
	MHS533R/L	9.4	15.7	4.5	1.2	1.2	—	
	MHS534R/L	9.4	15.7	4.5	1.6	1.6	—	
	MHS543R/L	9.4	15.7	6.5	1.2	1.2	—	
<p>Pozycja otworu tego elementu jest odsunięta od środka.</p>	MLCP42	12.58	3.18	1.2	1.2	1.2	1.2	Oprawki wytaczarskie typu P (☉E038)
	MLDP42	12.56	3.18	1.2	1.2	—	—	
<p>Pozycja otworu tego elementu jest odsunięta od środka.</p>	MLSP42	12.63	3.18	1.2	1.2	1.2	1.2	Oprawki wytaczarskie typu P (☉E037)
	MLTP32	9.50	3.18	1.2	1.2	1.2	—	
	MSCN63	18.8	4.76	1.6	1.6	1.6	1.6	Oprawka Z PODWÓJNYM SYSTEMEM MOCOWANIA (☉C009) (do ciężkiego skrawania)
	MSSN63	18.8	4.76	1.6	1.6	1.6	1.6	
	CT32T1	9.525	15.03	3.18	—	—	—	
	* PT32T1R	8.28	13.34	3.18	—	—	—	
	* PT32T2R	8.28	13.19	3.18	—	—	—	

Geometria	Numer zamówieniowy	Wymiary (mm)						Nazwa oprawki
		MPCA	MPCB	MPCC	MPCD	MPCE	MPCF	
	PV321	9.52	3.18	0.4	0.4	—	—	Oprawka typu MP (☉C019)
	PV322	9.52	3.18	0.8	0.8	—	—	
	PV323	9.52	3.18	1.2	1.2	—	—	
	SPSVN32	8.06	3.18	0.3	0.3	—	—	Oprawka typu SP (☉C030) Nazwa oprawki HSK (☉H001)
	STASX400N	11.00	3.00	0.4	0.4	0.4	0.4	ASX400 (☉K068)
	STASX445N	10.76	3.00	—	—	—	—	ASX445 (☉K026)
	STBS500N	12.7	3.18	0.8	0.8	0.8	0.8	
	WPSTN33	9.3	4.76	0.8	0.4	1.2	—	Oprawka typu WP (☉C017)
	WPSTN43	12.50	4.76	0.8	0.4	1.2	—	
	* WPSWC43	12.50	4.76	0.4	0.8	1.2	—	Oprawka typu WP (☉C023)
	WPSWN43	12.50	4.76	0.4	0.8	1.2	—	
	SPSDN32	8.687	3.175	—	—	—	—	

CZĘŚCI ZAPASOWE

KOŁKI I DŹWIGNIE MOCUJĄCE

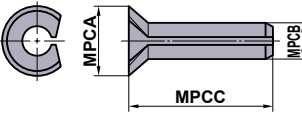
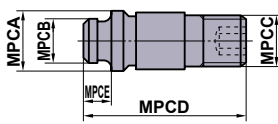
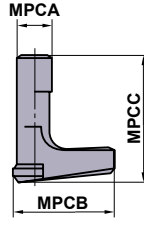
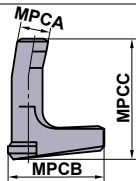
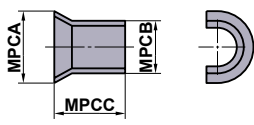
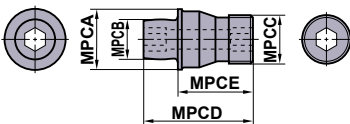
Geometria	Numer zamówieniowy	Wymiary (mm)					Nazwa oprawki
		MPCA	MPCB	MPCC	MPCD	MPCE	
	BCP141	3.0	1.4	5.6	—	—	Oprawka typu SP (☉C030)
	BCP201	4.3	2	7.4	—	—	Oprawki wytaczarskie typu F (☉E028)
	BCP202	4.3	2	6.4	—	—	Nazwa oprawki HSK (☉H013)
	BCP251	4.8	2.5	7.4	—	—	
	BCP252	4.8	2.5	6.4	—	—	
	BCP301	5.3	3	7.4	—	—	
	CCP33	6.5	3.66	M5×0.8	18.5	3	Oprawka WP (☉C017)
	CCP34	7.5	5.0	M6×1.0	18.5	3	
	CCP44	7.5	5.0	M5×0.8	14.2	3	
	LLCL12S	2.1	9.3	5.6	—	—	Oprawka typu LL (☉C016)
	LLCL13	3.6	10	12.5	—	—	Oprawki wytaczarskie typu P (☉E037)
	LLCL13S	3.6	10	7.8	—	—	Nazwa oprawki HSK (☉H001)
	LLCL14	4.7	13.4	13.2	—	—	
	LLCL14S	4.7	13.6	12.2	—	—	
	LLCL15	6.0	19	17	—	—	
	LLCL16	7.5	20.8	21	—	—	
	LLCL18	8.6	25.4	25.2	—	—	
	LLCL23	3.6	12.0	11.5	—	—	
	LLCL23S	3.6	11.6	9.5	—	—	
	LLCL24	4.7	16.2	14.8	—	—	
	LLCL25	6.0	17.1	17	—	—	
	LLCL110	3.0	10.7	11.6	—	—	
	LLCL112	3.5	13	13.5	—	—	
	LLCL116	4.5	18.5	18	—	—	
	LLCL120	5.6	20.3	19	—	—	
	LLCL125	6	24	24	—	—	
	LLCL132	8	30	27	—	—	
	LLP13	5.55	4.85	5.3	—	—	Oprawka typu LL (☉C008)
	LLP14	7.25	6.55	5.8	—	—	Oprawka Z PODWÓJNYM SYSTEMEM MOCOWANIA (☉C008)
	LLP15	8.8	8.05	8.6	—	—	OPRAWKA "DIMPLE BAR" Z PODWÓJNYM SYSTEMEM MOCOWANIA (☉E015)
	LLP16	10.85	9.85	11.1	—	—	Oprawki wytaczarskie typu P (☉E037)
	LLP18	15.35	13.05	12.0	—	—	Nazwa oprawki HSK (☉H001)
	LLP23	5.55	4.85	6.8	—	—	
	LLP24	7.25	6.55	9.1	—	—	
	MP6	11.9	7.8	M10×1	22.1	15	Oprawka Z PODWÓJNYM SYSTEMEM MOCOWANIA (☉C009) (do ciężkiego skrawania)

KOLEK USTALAJĄCY

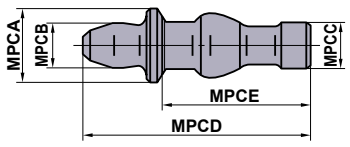
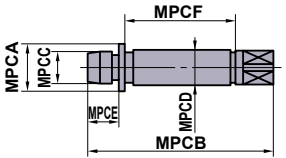
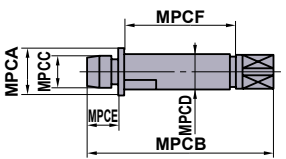
Geometria	Numer zamówieniowy	Wymiary (mm)						Nazwa oprawki
		MPCA	MPCB	MPCC	MPCD	MPCE	MPCF	
	P11S	6	3.7	4	17	11.1	—	Oprawka typu MP (C019)
	P21S	7.5	4.9	4.5	17.2	11.5	—	
	P221US	4	18	2.11	3.5	3.3	7.7	
	P333WS	5.75	24	3.64	5.0	4.9	11.3	
	P434W	7.75	30	5.03	7.0	4.9	16.8	

PŁYTKA DOCISKOWA

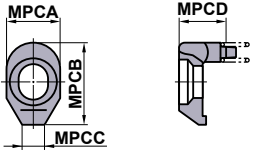
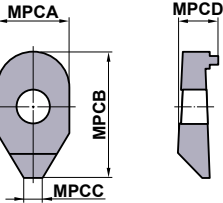
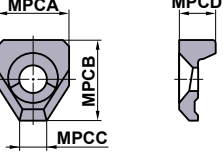
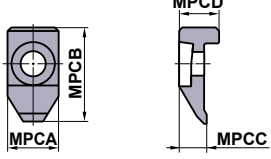
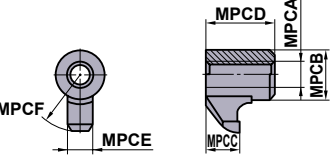
Geometria	Numer zamówieniowy	Wymiary (mm)						Nazwa oprawki
		MPCA	MPCB	MPCC	MPCD	MPCE	MPCF	
	AMS3	7	12	3	3.3	—	—	Oprawka Profil (C032) AJX (K180)
	AMS4	9	13.5	3	3.8	—	—	
	AMS5	10	15	3.5	5	—	—	
	CA142	8	15	4	7	—	—	
	CA150	9	16	4.5	7	—	—	
	CA151	10	17	5	7	—	—	
	CA152	10	19	5	7	—	—	
	CA153	10	24	5	7	—	—	
	CA161	13	20	6	8	—	—	
	CA162	13	24	6	8	—	—	
	CA163	13	27	6	8	—	—	
	CA181	16	30	8	10	—	—	
CA183	16	37	8	10	—	—		
	CCK13	15	18.5	6	9	—	—	Oprawka typu WP (C017)
	CCK14	19	22	8	9.5	—	—	
	CCTC1	13	25	7	10.2	—	—	
	CK231	M6×1	8	4	7.5	4.5	9.5	
	CK232	M6×1	8	4.5	8	4.5	11.5	
	CK341	M8×1	11	5.5	13.5	6	13.5	
	CK342	M8×1	11	6	14	6	16.5	

CZĘŚCI ZAPASOWE

PŁYTKA DOCISKOWA

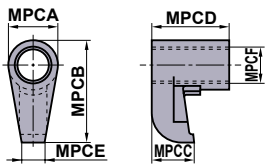
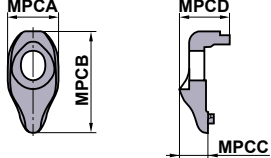
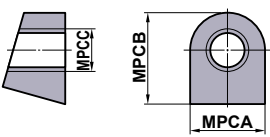
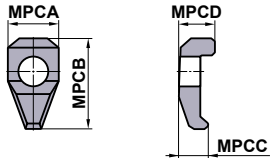
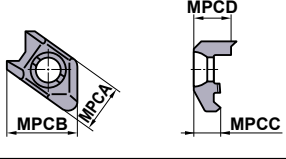
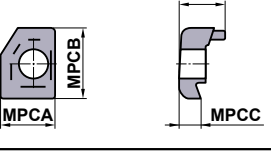
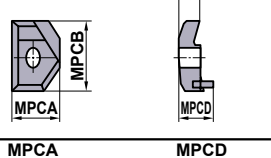
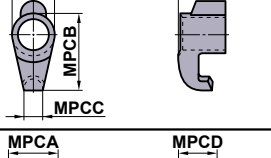
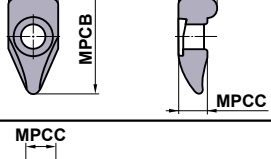
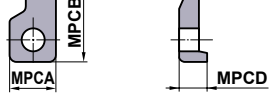
Geometria	Numer zamówieniowy	Wymiary (mm)						Nazwa oprawki
		MPCA	MPCB	MPCC	MPCD	MPCE	MPCF	
	CKW6	10.9	22.5	9.2	16.8	5	M8×1	Oprawka z PODWÓJNYM SYSTEMEM MOCOWANIA (☉C009) (do ciężkiego skrawania)
	DCK2211 DCK2613 DCK3113	11 13 13	22 26.5 31	6.57 7.35 9	11.1 12.9 14.5	— — —	— — —	Oprawka z PODWÓJNYM SYSTEMEM MOCOWANIA (☉C008) OPRAWKA "DIMPLE BAR" z PODWÓJNYM SYSTEMEM MOCOWANIA (☉E015) Nazwa oprawki HSK (☉H001)
	KGC1	12.0	15.0	M7×0.75	—	—	—	
	LK1	8	14.3	4.5	5.9	—	—	
	MHK5NR/L	15.5	23.5	8.1	12.1	—	—	
	MTK1R/L	13	17.5	5	12	—	—	Oprawka typu MG (☉F124) Oprawka typu MT (☉G024) Nazwa oprawki HSK (☉H001)
	MTK2R/L	18	28	7	14	—	—	
	SETK51 SETK61	6.8 8.9	14.5 18.1	2.9 4.1	8 8.6	— —	— —	Oprawka typu MMTE (☉G019) Oprawka typu MMTI (☉G026) Nazwa oprawki HSK (☉H001)
	SRK1R	9.4	21	5.5	7.5	—	—	
	UCR	12	24	8	7	—	—	

ŁAMACZ WIÓRA

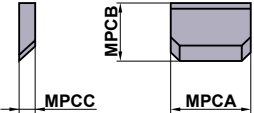
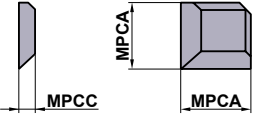
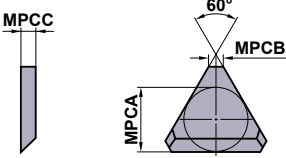
Geometria	Numer zamówieniowy	Wymiary (mm)					Nazwa oprawki
		MPCA	MPCB	MPCC	IC	LBB	
	CBS3	9.4	8.0	1.5	9.525	1.5	
	CBS4	12.6	9.2	2.5	12.70	3.5	
	CBS4N	12.6	10.2	2.5	12.70	2.5	
	CBS4F	12.6	11.2	2.5	12.70	1.5	
	CBS6	18.9	14.6	2.5	19.05	4.5	
	CBS6F	18.9	17.6	2.5	19.05	1.5	
	CBS3D	8.0	—	1.5	9.525	1.5	
	CBS4D	10.2	—	2.5	12.70	2.5	
	CBT2N	5.67	1.4	1.5	6.35	1.0	Oprawki wytaczarskie typu F (⊕E028) *Dla płytki o geometrii dodatknej szerokość łamacza wióra wynosi o 0.5mm więcej, niż podano w tabeli.
	CBT3	7.20	1.4	2.5	9.525	3.5	
	CBT3N	7.87	1.4	2.5	9.525	2.5	
	CBT3F	8.53	1.4	2.5	9.525	1.5	
	CBT4N	11.07	1.4	2.5	12.70	2.5	
	CBT4F	11.73	1.4	2.5	12.70	1.5	

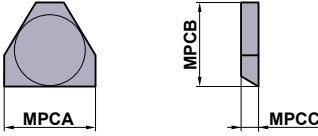
Geometria	Numer zamówieniowy	Wymiary (mm)			MPCD (mm)	Nazwa oprawki
		MPCA	MPCB	MPCC		
	CBT3106	11.5	10.6	2.0	2.5—3.0	
	CBT3113	11.5	11.3	2.0	1.5—2.0	
	CBT3120	11.5	12	2.0	0.75—1.25	

N

CZĘŚCI ZAPASOWE

SMAR ZAPOBIEGAJĄCY ZATARCIU

SMAR ZAPOBIEGAJĄCY ZATARCIU

Kształt	Numer zamówieniowy	Dostępność	Pojemność (g)
	MK1K	★	20
	MK1KS	★	3

N

CZĘŚCI ZAPASOWE

★ : Na specjalne zamówienie z magazynu w Japonii.

Notatki

A series of horizontal dashed lines for writing notes, spanning the width of the page.

INFORMACJE TECHNICZNE

ZGODNIE Z ISO13399.....	P002
ELIMINOWANIE PROBLEMÓW (WIERCENIE).....	P006
ZUŻYCIE WIERTŁA I USZKODZENIE KRAWĘDZI SKRAWAJĄCEJ	P007
BUDOWA I DANE TECHNICZNE WIERTEŁ.....	P008
OBLICZANIE PARAMETRÓW WIERCENIA.....	P011
TABELA PORÓWNAWCZA MATERIAŁÓW (METALE)	P012
CHROPOWATOŚĆ POWIERZCHNI.....	P016
TABELA PORÓWNAWCZA TWARDOŚCI.....	P017
POLA TOLERANCJI OTWORÓW.....	P018
POLA TOLERANCJI WAŁKÓW	P020
ŚREDNICE WIERTEŁ POD GWINT.....	P022
WYMIARY GNIAZD ŚRUB IMBUSOWYCH.....	P023
MIĘDZYNARODOWY UKŁAD JEDNOSTEK MIARY	P024



ZGODNIE Z ISO13399

Parametry narzędzi skrawających zgodne z normą ISO 13399

Alfabetycznie

Źródło: Norma ISO 13399

URL : <https://www.iso.org/search/x/query/13399>

Parametr wg ISO 13399	Znaczenie
ADJLX	Maksymalny zakres regulacji
ADJRG	Zakres regulacji
ALF	Kąt przyłożenia boczny
ALP	Kąt przyłożenia promieniowy
AN	Kąt przyłożenia, główny
ANN	Pomocniczy kąt przyłożenia
APMX	Maksymalna głębokość skrawania
AS	Kąt przyłożenia krawędzi wygładzającej (wiper) płytki
ASP	Wystawanie śruby regulacyjnej
AZ	Maksymalna głębokość zagłębiania osiowego
B	Szerokość chwytu
BBD	Wyważony konstrukcyjnie
BCH	Długość ścinu
BD	Średnica korpusu
BDX	Maksymalna średnica korpusu
BHCC	Liczba otworów pod śruby
BHTA	Kąt stożka korpusu
BMC	Oznaczenie materiału korpusu
BS	Długość krawędzi wygładzającej (wiper)
BSR	Promień naroża krawędzi wygładzającej (wiper)
CASC	Oznaczenie wielkości kasety
CB	Liczba krawędzi z łamaczem wióra
CBDP	Głębokość otworu łączenia
CBMD	Oznaczenie łamacza wióra producenta
CBP	Typ łamacza wióra
CCMS	Oznaczenie złącza po stronie obrabiarki
CCWS	Oznaczenie złącza po stronie przedmiotu obrabianego
CCP	Typ fazki naroża płytki
CDI	Średnica skrawania płytki
CDX	Maksymalna głębokość skrawania
CEATC	Oznaczenie typu kąta krawędzi skrawającej
CECC	Oznaczenie stanu krawędzi skrawającej
CEDC	Liczba krawędzi skrawających
CF	Szerokość ścinu na profilu ostrza
CHW	Szerokość fazki naroża ostrza
CICT	Liczba elementów skrawających
CNC	Liczba naroży
CND	Średnica podłączenia chłodziwa
CNSC	Oznaczenie typu wlotu chłodziwa
CNT	Wielkość gwintu wlotu chłodziwa
CP	Ciśnienie chłodziwa
CRE	Promień naroża
CRKS	Wielkość gwintu śruby ściągnącej złącza
CSP	Typ zasilania chłodziwem
CTP	Typ powłoki
CTX	Przesunięcie punktu skrawania w osi X
CTY	Przesunięcie punktu skrawania w osi Y
CUTDIA	Maksymalna średnica przecinanego przedmiotu
CUB	Baza jednostki złącza
CW	Szerokość skrawania
CWX	Maksymalna szerokość skrawania
CXD	Średnica wylotu chłodziwa

Parametr wg ISO 13399	Znaczenie
CXSC	Oznaczenie typu wylotu chłodziwa
CZC	Oznaczenie wielkości złącza
D1	Średnica otworu mocującego
DAH	Średnica otworu dostępowego
DAXN	Minimalna średnica zewnętrzna rowka osiowego
DAXX	Maksymalna średnica zewnętrzna rowka osiowego
DBC	Średnica rozstawienia kołków
DC	Średnica skrawania
DCB	Średnica otworu mocującego
DCBN	Minimalna średnica otworu mocującego
DCBX	Maksymalna średnica otworu mocującego
DCC	Oznaczenie typu wersji konstrukcyjnej
DCCB	Średnica otworu złącza pogłębiacza
DCIN	Wewnętrzna średnica skrawania
DCINN	Minimalna wewnętrzna średnica skrawania
DCINX	Maksymalna wewnętrzna średnica skrawania
DCN	Minimalna średnica skrawania
DCON	Średnica złącza
DCONMS	Wielkość złącza po stronie obrabiarki
DCONWS	Wielkość złącza po stronie przedmiotu obrabianego
DCSC	Oznaczenie wielkości średnicy skrawania
DCSFMS	Średnica powierzchni stycznej po stronie maszyny
DCX	Maksymalna średnica skrawania
DF	Średnica kołnierza
DHUB	Średnica piasty
DMIN	Średnica minimalna otworu obrabianego
DMM	Średnica chwytu
DN	Średnica szyjki
DRVA	Kąt elementu skrawającego
EPSR	Kąt zawarty płytki
FHA	Kąt pochylenia linii śrubowej rowków wiórowych
FHCSA	Kąt pogłębienia w otworze mocującym
FHCSD	Średnica sfazowania otworu mocującego
FLGT	Grubość kołnierza
FMT	Typ kształtu
FXHLP	Typ otworu mocującego
GAMF	Promieniowy kąt natarcia
GAMN	Kąt natarcia normalny
GAMO	Kąt natarcia w płaszczyźnie ortogonalnej
GAMP	Kąt natarcia promieniowy
GAN	Kąt natarcia płytki
H	Wysokość chwytu
HA	Teoretyczna wysokość zarysu gwintu
HAND	Kierunek pracy narzędzia
HBH	Wysokość przesunięcia spodu głowicy
HBKL	Długość offsetu tyłu głowicy
HBKW	Szerokość przesunięcia tyłu głowicy
HBL	Szerokość offsetu tyłu głowicy
HC	Wysokość zarysu gwintu
HF	Wysokość funkcjonalna
HHUB	Wysokość piasty
HTB	Wysokość korpusu
IC	Średnica okręgu wpisanego
IFS	Oznaczenie typu mocowania płytki
IIC	Oznaczenie złącza płytki
INSL	Długość płytki
KAPR	Kąt krawędzi skrawającej narzędzia
KCH	Kąt fazki naroża

INFORMACJE TECHNICZNE

Parametr wg ISO 13399	Znaczenie
KRINS	Kąt głównej krawędzi skrawającej
KWW	Szerokość rowka wpustowego
KYP	Typ rowka wpustowego
L	Długość krawędzi skrawającej
LAMS	Kąt pochylenia
LB	Długość korpusu
LBB	Szerokość łamacza wióra
LBX	Maksymalna długość korpusu
LCCB	Głębokość otworu złącza pogłębiacza
LCF	Długość rowka wiórowego
LDRED	Długość zredukowanej średnicy korpusu
LE	Efektywna długość krawędzi skrawającej
LF	Długość funkcjonalna
LFA	Wymiar na długości funkcjonalnej
LH	Długość głowicy
LPR	Długość wystawiania
LS	Długość chwytu
LSC	Długość mocowania
LSCN	Minimalna długość mocowania
LSCX	Maksymalna długość mocowania
LTA	Długość LTA (odległość od MCS do CRP)
LU	Długość użyteczna
LUX	Maksymalna długość użyteczna
M	Wymiar m
M2	Odległość między nominalnym okręgiem wpisanym a narożem płytki posiadającym pomocniczy kąt naroża
MHA	Kąt otworu montażowego
MHD	Odległość otworu montażowego
MHH	Wysokość otworu montażowego
MIID	Oznaczenie płytki głównej
MTP	Oznaczenie typu mocowania
NCE	Liczba stron tnących
NOF	Liczba rowków
NOI	Liczba krawędzi
NT	Liczba ostrzy
OAH	Wysokość całkowita
OAL	Długość całkowita
OAW	Szerokość całkowita
PDPT	Głębokość profilu płytki
PDX	Odległość profilu ex
PDY	Odległość profilu ey
PFS	Oznaczenie typu profilu
PL	Długość wierzchołka
PNA	Kąt zawarty profilu
PRFRAD	Promień profilu
PSIR	Kąt przystawienia narzędzia
PSIRL	Kąt głównej krawędzi skrawającej, lewy
PSIRR	Kąt głównej krawędzi skrawającej, prawy
RAL	Kąt przyłożenia, lewy
RAR	Kąt przyłożenia, prawy
RCP	Zaokrąglone naroże
RE	Promień naroża
REL	Promień naroża, lewy
RER	Promień naroża, prawy
RMPX	Maksymalny kąt zagłębiania skośnego
RPMX	Maksymalna prędkość obrotowa
S	Grubość płytki
S1	Promień przedmiotu obrabianego
SC	Całkowita grubość płytki
SDL	Długość średnicy stopnia
SIG	Kąt wierzchołkowy

Parametr wg ISO 13399	Znaczenie
SSC	Oznaczenie wielkości gniazda płytki
SX	Oznaczenie kształtu przekroju trzonka
TC	Klasa tolerancji płytki
TCE	Oznaczenie końcówki krawędzi skrawającej
TCTR	Klasa tolerancji gwintu
TD	Średnica gwintu
THFT	Zarys gwintu
THL	Długość gwintu
THLGTH	Długość gwintu
THSC	Oznaczenie kształtu trzonka narzędzia
THUB	Grubość piasty
TP	Skok gwintu
TPI	Liczba zwojów gwintu na cal
TPIN	Minimalna liczba zwojów/ cal
TPIX	Maksymalna liczba zwojów/ cal
TPN	Minimalny skok gwintu
TPT	Zarys gwintu
TPX	Maksymalny skok gwintu
TQ	Moment obrotowy
TSYC	Oznaczenie główne, tj. typ narzędzia
TTP	Typ gwintu
ULDR	Stosunek długości użytkowej do średnicy
UST	Układ jednostek
W1	Szerokość płytki
WEP	Krawędź dogładzająca
WF	Szerokość funkcjonalna
WF2	Odległość między narożem programowanym płytki a chwytem
WFS	Szerokość funkcjonalna pomocnicza
WT	Masa elementu
ZEFF	Liczba efektywnych ostrzy na czole
ZEPF	Liczba peryferyjnych efektywnych krawędzi skrawających
ZNC	Liczba ostrzy centralnych
ZNF	Liczba płytek czołowych
ZNP	Liczba płytek obwodowych

Lista symboli odniesienia zgodnych z normą ISO 13399

ISO 13399 Symbole odniesienia	Znaczenie
CIP	Układ współrzędnych CIP
CRP	Punkt odniesienia skrawania
CSW	Układ współrzędnych przedmiotu obrabianego
MCS	Układ współrzędnych uchwytu
PCS	Główny układ współrzędnych

ZUŻYCIE WIERTŁA I USZKODZENIE KRAWĘDZI SKRAWAJĄCEJ

■ STAN ZUŻYCIA WIERTŁA

Poniższy rysunek przedstawia sposób zużywania się krawędzi skrawającej wiertła. Sposób powstawania i wielkość zużycia zależy od materiału przedmiotu obrabianego i warunków skrawania. Generalnie jednak zużycie pomocniczej krawędzi skrawającej jest największe i decyduje o żywotności wiertła. Podczas ostrzenia zużycie na powierzchni przyłożenia przy wierzchołku powinno być całkowicie zeszlifowane. Im większe zużycie, tym więcej materiału należy zeszlifować w celu naostrzenia krawędzi skrawającej.

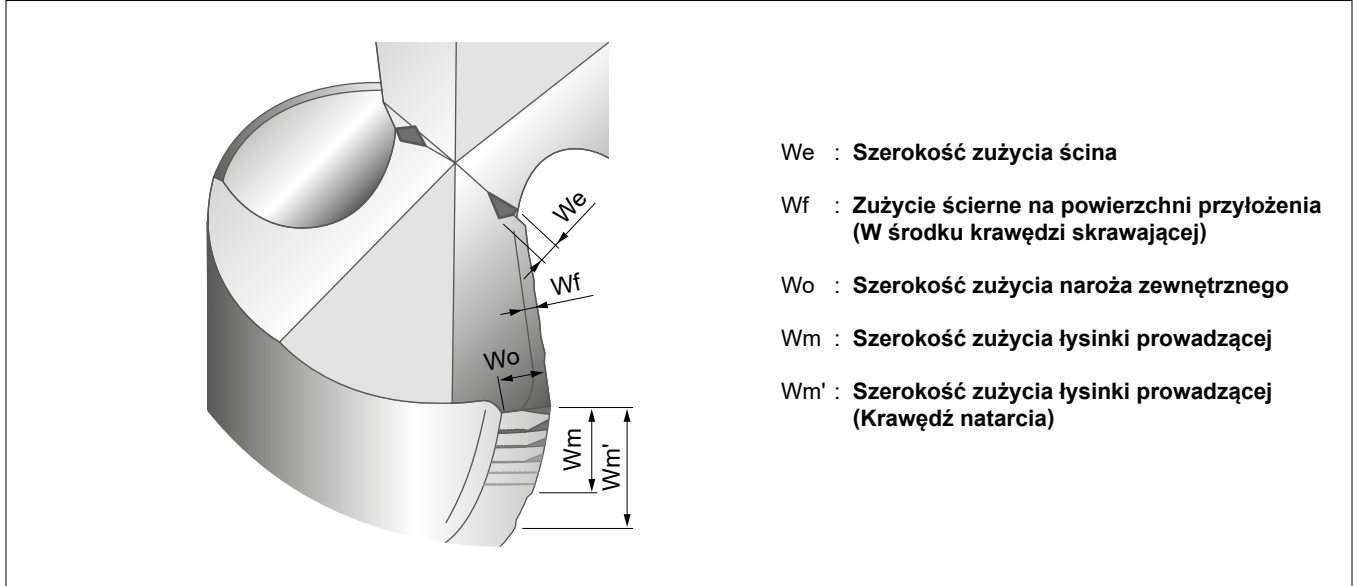

■ USZKODZENIE KRAWĘDZI SKRAWAJĄCEJ

Podczas wiercenia na krawędzi skrawającej mogą powstać wykruszenia, pęknięcia i inne nietypowe uszkodzenia. W takich przypadkach istotne jest dokładniejsze zbadanie uszkodzenia, znalezienie przyczyny i podjęcie środków zaradczych.

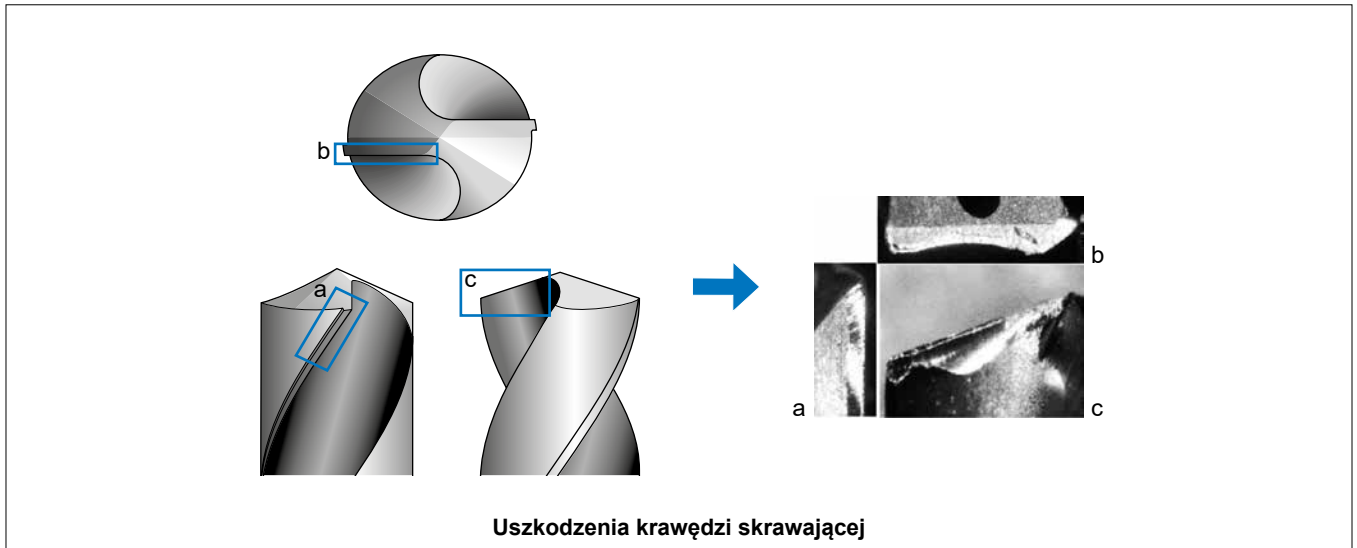

BUDOWA I DANE TECHNICZNE WIERTEŁ

■ NOMENKLATURA

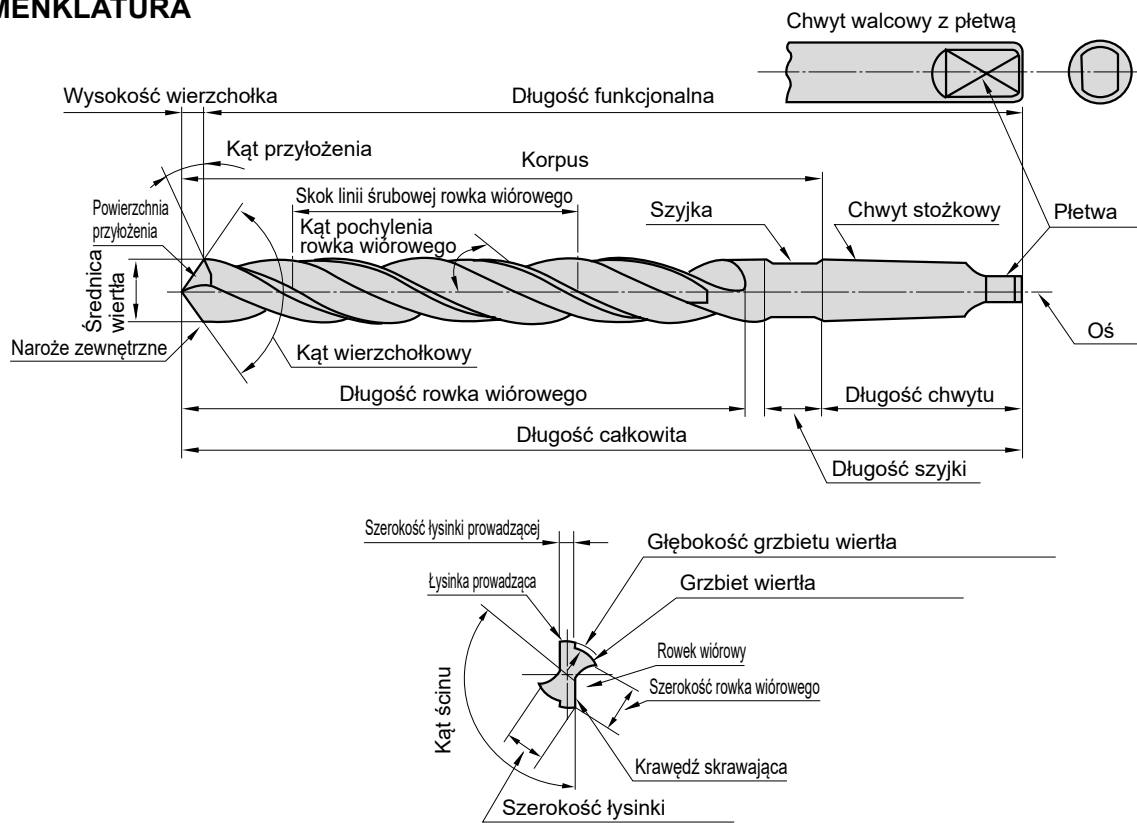

INFORMACJE TECHNICZNE

■ PARAMETRY KSZTAŁTU A SKRAWNOŚĆ

Kąt pochylenia rowka wiórowego	To kąt pochylenia linii śrubowej rowka wiórowego względem osi wiertła, od którego zależy kąt natarcia wiertła. Kąt natarcia wiertła zmienia się w zależności od położenia krawędzi skrawającej i zmniejsza się znacznie w miarę przechodzenia od brzegu w kierunku osi wiertła. Materiały o dużej twardości Mały ◀•• Kąt natarcia ••▶ Duży Materiały miękkie (Aluminium, itd.)				
Długość rowka wiórowego	Zależy od głębokości otworu, długości tulejki i nadkładu na ostrzenie. Ponieważ ma on duży wpływ na żywotność narzędzia, powinien być jak najkrótszy.				
Kąt wierzchołkowy	Zwykle kąt wierzchołkowy wynosi 118°. Inny kąt w zależności od zastosowania. Materiał miękki o dobrej obrabialności Mały ◀•• Kąt wierzchołkowy ••▶ Duży Materiały twarde i wysoka wydajność obróbki				
Grubość rdzenia	Jest to ważny parametr, który determinuje sztywność i skuteczność łamania wióra przez wiertło. Grubość rdzenia zależy od zastosowania wiertła. <table style="display: inline-table; vertical-align: middle;"> <tr> <td style="border: none;"> Niskie opory skrawania Mała sztywność Dobra skuteczność łamania wióra Materiał o dobrej skrawalności </td> <td style="border: none; font-size: 2em; vertical-align: middle;">}</td> <td style="border: none; vertical-align: middle;">Mała ◀•• Grubość rdzenia ••▶ Duża</td> <td style="border: none;"> Wysokie opory skrawania Wysoka sztywność Niska skuteczność łamania wióra Materiał o dużej twardości, wiercenie otworów krzyżujących się, itd. </td> </tr> </table>	Niskie opory skrawania Mała sztywność Dobra skuteczność łamania wióra Materiał o dobrej skrawalności	}	Mała ◀•• Grubość rdzenia ••▶ Duża	Wysokie opory skrawania Wysoka sztywność Niska skuteczność łamania wióra Materiał o dużej twardości, wiercenie otworów krzyżujących się, itd.
Niskie opory skrawania Mała sztywność Dobra skuteczność łamania wióra Materiał o dobrej skrawalności	}	Mała ◀•• Grubość rdzenia ••▶ Duża	Wysokie opory skrawania Wysoka sztywność Niska skuteczność łamania wióra Materiał o dużej twardości, wiercenie otworów krzyżujących się, itd.		
Łysinka prowadząca	Określa średnicę wiertła i służy do prowadzenia wiertła podczas wiercenia. Szerokość łysinki prowadzącej zależy od tarcia występującego w wierconym otworze. Złe prowadzenie wiertła Mała ◀•• Szerokość łysinki prowadzącej ••▶ Duża Dobre prowadzenie wiertła				
Zbieżność średnicy w kierunku chwytu	Celem zmniejszenia tarcia o wewnętrzną powierzchnię wierconego otworu, część rowka wiórowego od wierzchołka do chwytu ma niewielką zbieżność w kierunku chwytu. Zbieżność ta polega na zmniejszeniu średnicy wzdłuż rowka wiórowego i wynosi około 0.04–0.1mm. Jest ona większa dla wiertel szybkoobrotowych i w przypadku materiałów obrabianych, w których wiercony otwór może się zatykać wiórami.				

■ GEOMETRIA KRAWĘDZI SKRAWAJĄCEJ I JEJ WPŁYW NA OBRÓBKĘ

Jak pokazano w poniższej tabeli, istnieje możliwość wyboru najbardziej odpowiedniej geometrii krawędzi skrawającej do różnych zastosowań. Prawidłowy wybór geometrii krawędzi skrawającej skutkuje większą wydajnością obróbki i wyższą dokładnością otworu.

● Kształty Krawędzi Skrawających

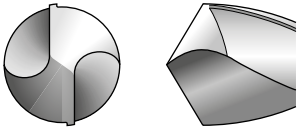
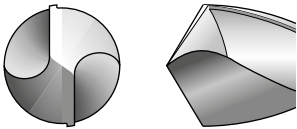
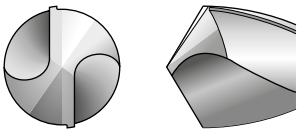
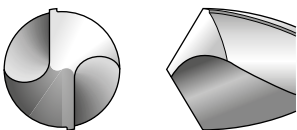
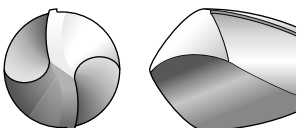
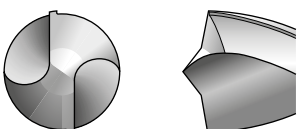
Typ zaszlifowania	Kształt	Opis i efekt	Zastosowanie
Stożkowe		<ul style="list-style-type: none"> Powierzchnia przyłożenia ma kształt stożkowy a kąt przyłożenia wzrasta w kierunku osi wiertła. 	<ul style="list-style-type: none"> Zastosowanie uniwersalne
Płaskie		<ul style="list-style-type: none"> Powierzchnia przyłożenia jest płaska. Łatwe ostrzenie. 	<ul style="list-style-type: none"> Głównie do wiertel o małej średnicy.
Trójstopniowe		<ul style="list-style-type: none"> Ponieważ wiertło nie posiada ścina, wysoka jest siła dośrodkowa i otwór jest nieznacznie nadwymiarowy. Do ostrzenia wymagana jest specjalna szlifierka. Szlifowanie powierzchni z trzech stron. 	<ul style="list-style-type: none"> Do operacji wiercenia wymagających wysokiej dokładności otworu i pozycjonowania.
Spiralne		<ul style="list-style-type: none"> Kąt przyłożenia wzrasta w kierunku osi wiertła, połączenie zaszlifowania stożkowego ze zmiennym kątem pochylenia rowka wiórowego. Ścin wiertła typu S, duża siła dośrodkowa i wysoka dokładność obróbki. 	<ul style="list-style-type: none"> Do wiercenia z wysoką dokładnością.
Promieniowe		<ul style="list-style-type: none"> Krawędź skrawająca jest szlifowana promieniowo, celem uzyskania lepszego rozkładu obciążeń. Wysoka dokładność obróbki i gładkość powierzchni po obróbce. Do otworów przelotowych, małe zadziory przy wylocie otworu. Do ostrzenia wymagana jest specjalna szlifierka. 	<ul style="list-style-type: none"> Żeliwo, Stopy aluminium Płyty żeliwne. Stal
Z ostrzem centrującym		<ul style="list-style-type: none"> Ten kształt charakteryzuje się podwójnym kątem wierchołkowym, co zapewnia lepszą współosiowość oraz zmniejszenie obciążeń uderowych przy wychodzeniu z przedmiotu obrabianego. 	<ul style="list-style-type: none"> Wiercenie cienkich blach.







■ KOREKCJA ŚCINA

Kąt natarcia krawędzi skrawającej zmniejsza się w kierunku osi i zmienia się na ujemny przy ścinie wiertła. Podczas wiercenia środek wiertła wcina się w materiał i tu wytwarza się 50–70% oporów skrawania. Korekcja ścina to bardzo skuteczna metoda zmniejszenia oporów skrawania wiertła, szybkiego usuwania wióra spod ścina i lepszego wcinania się wiertła na początku wiercenia.

Kształt	Typ X	Typ XR	Typ S	Typ N
Opis	Znaczne obniżenie się posuwowej siły skrawania i skuteczności wcinania. Ten typ kształtu jest skuteczny wtedy, gdy rdzeń wiertła jest gruby.	Skuteczność wcinania się wiertła jest nieznacznie niższa niż dla korekty typu X, ale krawędź skrawająca jest twarda i zakres stosowania jest szeroki.	Łatwe skrawanie. Ten kształt jest zwykle stosowany.	Skuteczne wtedy, gdy rdzeń wiertła jest stosunkowo gruby.
Główne obszary zastosowania	Wiercenie ogólne i wiercenie głębokich otworów.	Długa żywotność. Wiercenie ogólne i wiercenie w stali nierdzewnej.	Wiercenie ogólne w stali, żeliwie i metalach nieżelaznych.	Wiercenie głębokich otworów.

BUDOWA I DANE TECHNICZNE WIERTEŁ

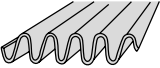
■ WIÓR POWSTAJĄCY PODCZAS WIERCENIA

Typy wióra	Kształt wióra	Cechy i łamliwość wióra
Stożkowy, spiralny		Wiór spiralny, skręcający w rowku wiórowym. Wiór tego typu powstaje podczas wiercenia w materiale ciągliwym z małym posuwem. Jeśli wiór łamie się po kilku skrętach, skuteczność łamania jest dostateczna.
Długi, wstęgowy		Długi, wstęgowy wiór powstaje podczas obróbki bez chłodzenia i łatwo owija się wokół wiertła.
Pojedynczy skręt		Jest to wiór łamiący się w rowku wiórowym i na ściankach wierconego otworu. Powstaje wtedy, gdy posuw jest duży.
Segmentowy		Wiór stożkowy, spiralny, łamany bezpośrednio przed powstaniem wióra wstęgowego na ściance wierconego otworu, wskutek zbyt małej ciągliwości materiału. Doskonały spływ i odprowadzanie wióra.
Zygzakowaty		Wiór, który wygina się tworząc harmonijkę z powodu kształtu rowka wiórowego i własności materiału. Łatwo następuje gromadzenie się wióra w rowku wiórowym.
Igielkowy		Wiór łamiący się wskutek drgań lub zwijania materiału kruchego z małym promieniem. Łamliwość jest zadowalająca, ale wiór może się ubijać.

OBLICZANIE PARAMETRÓW WIERCENIA

■ PRĘDKOŚĆ SKRAWANIA (V_c)

$$V_c = \frac{\pi \cdot DC \cdot n}{1000} \text{ (m/min)}$$

V_c (m/min): Prędkość skrawania DC (mm) : Średnica wiertła
 π (3.14) : Pi n (min^{-1}) : Obroty wrzeciona

*Aby otrzymać wymiar w metrach, należy wymiar w milimetrach podzielić przez 1000.

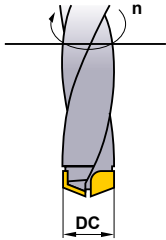

(Przykład) Ile wynosi prędkość skrawania, gdy prędkość obrotowa wrzeciona $n = 1350 \text{ min}^{-1}$ a średnica zewnętrzna wynosi 12mm ?

(Odpowiedź) Podstawiamy do wzoru $\pi = 3.14$, $DC = 12$, $n = 1350$

$$V_c = \frac{\pi \cdot DC \cdot n}{1000} = \frac{3.14 \times 12 \times 1350}{1000} = 50.9 \text{ m/min}$$

Prędkość skrawania wynosi 50.9m/min.

■ POSUW WRZECIONA (V_f)

$$V_f = fr \cdot n \text{ (mm/min)}$$

V_f (mm/min) : Posuw wrzeciona głównego (oś Z)
 fr (mm/obr.) : Posuw na obrót
 n (min^{-1}) : Obroty wrzeciona

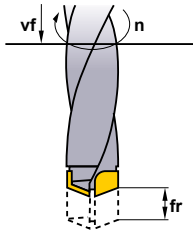

(Przykład) Jaki jest posuw wrzeciona (V_f), gdy posuw na obrót wynosi 0.2mm/obr. a prędkość obrotowa wrzeciona wynosi 1350 min^{-1} ?

(Odpowiedź) Podstawiamy do wzoru $fr = 0.2$, $n = 1350$

$$V_f = fr \cdot n = 0.2 \times 1350 = 270 \text{ mm/min}$$

Posuw wrzeciona wynosi 270mm/min.

■ CZAS WIERCENIA (T_c)

$$T_c = \frac{ld \cdot i}{n \cdot fr}$$

T_c (min) : Czas wiercenia
 n (min^{-1}) : Prędkość obrotowa wrzeciona
 ld (mm) : Głębokość otworu
 fr (mm/obr.) : Posuw na obrót
 i : Liczba otworów

(Przykład) Jaki jest czas potrzebny na wywiercenie otworu o głębokości 30 mm w stali stopowej z prędkością 50 m/min, gdy posuw wynosi 0.15 mm/obr. ?

(Odpowiedź) Prędkość obrotowa wrzeciona $n = \frac{50 \times 1000}{15 \times 3.14} = 1061.57 \text{ min}^{-1}$

$$T_c = \frac{30 \times 1}{1061.57 \times 0.15} = 0.188$$
$$= 0.188 \times 60 \approx 11.3 \text{ s}$$

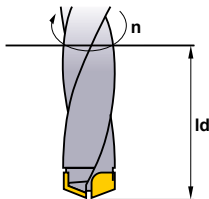

: Obroty wrzeciona

TABELA PORÓWNAWCZA MATERIAŁÓW (METALE)

■ STAL WĘGLOWA

Niemcy		Wielka Brytania		Francja	Włochy	Hiszpania	Szwecja	Japonia	USA	Chiny
W-nr.	DIN	BS	EN	AFNOR	UNI	UNE	SS	JIS	AISI/SAE	GB
1.0038	RSt.37-2	4360 40 C	–	E 24-2 Ne	–	–	1311	STKM 12A STKM 12C	A570.36	15
1.0401	C15	080M15	–	CC12	C15, C16	F.111	1350	–	1015	15
1.0402	C22	050A20	2C	CC20	C20, C21	F.112	1450	–	1020	20
1.0715	9SMn28	230M07	1A	S250	CF9SMn28	F.2111 11SMn28	1912	SUM22	1213	Y15
1.0718	9SMnPb28	–	–	S250Pb	CF9SMnPb28	11SMnPb28	1914	SUM22L	12L13	–
1.0722	10SPb20	–	–	10PbF2	CF10Pb20	10SPb20	–	–	–	–
1.0736	9SMn36	240M07	1B	S300	CF9SMn36	12SMn35	–	–	1215	Y13
1.0737	9SMnPb36	–	–	S300Pb	CF9SMnPb36	12SMnP35	1926	–	12L14	–
1.1141	Ck15	080M15	32C	XC12	C16	C15K	1370	S15C	1015	15
1.1158	Ck25	–	–	–	–	–	–	S25C	1025	25
1.8900	StE380	4360 55 E	–	–	FeE390KG	–	2145	–	A572-60	–
1.0501	C35	060A35	–	CC35	C35	F.113	1550	–	1035	35
1.0503	C45	080M46	–	CC45	C45	F.114	1650	–	1045	45
1.0726	35S20	212M36	8M	35MF4	–	F210G	1957	–	1140	–
1.1157	40Mn4	150M36	15	35M5	–	–	–	–	1039	40Mn
1.1167	36Mn5	–	–	40M5	–	36Mn5	2120	SMn438(H)	1335	35Mn2
1.1170	28Mn6	150M28	14A	20M5	C28Mn	–	–	SCMn1	1330	30Mn
1.1183	Cf35	060A35	–	XC38TS	C36	–	1572	S35C	1035	35Mn
1.1191	Ck45	080M46	–	XC42	C45	C45K	1672	S45C	1045	Ck45
1.1213	Cf53	060A52	–	XC48TS	C53	–	1674	S50C	1050	50
1.0535	C55	070M55	9	–	C55	–	1655	–	1055	55
1.0601	C60	080A62	43D	CC55	C60	–	–	–	1060	60
1.1203	Ck55	070M55	–	XC55	C50	C55K	–	S55C	1055	55
1.1221	Ck60	080A62	43D	XC60	C60	–	1678	S58C	1060	60Mn
1.1274	Ck101	060A96	–	XC100	–	F.5117	1870	–	1095	–
1.1545	C105W1	BW1A	–	Y105	C36KU	F.5118	1880	SK3	W1	–
1.1545	C105W1	BW2	–	Y120	C120KU	F.515	2900	SUP4	W210	–

■ STAL STOPOWA

Niemcy		Wielka Brytania		Francja	Włochy	Hiszpania	Szwecja	Japonia	USA	Chiny
W-nr.	DIN	BS	EN	AFNOR	UNI	UNE	SS	JIS	AISI/SAE	GB
1.0144	St.44.2	4360 43 C	–	E28-3	–	–	1412	SM400A, SM400B SM400C	A573-81	–
1.0570	St52-3	4360 50 B	–	E36-3	Fe52BFN Fe52CFN	–	2132	SM490A, SM490B SM490C	–	–
1.0841	St52-3	150M19	–	20MC5	Fe52	F.431	2172	–	5120	–
1.0904	55Si7	250A53	45	55S7	55Si8	56Si7	2085	–	9255	55Si2Mn
1.0961	60SiCr7	–	–	60SC7	60SiCr8	60SiCr8	–	–	9262	–
1.3505	100Cr6	534A99	31	100C6	100Cr6	F.131	2258	SUJ2	ASTM 52100	Gr15, 45G
1.5415	15Mo3	1501-240	–	15D3	16Mo3KW	16Mo3	2912	–	ASTM A204Gr.A	–
1.5423	16Mo5	1503-245-420	–	–	16Mo5	16Mo5	–	–	4520	–
1.5622	14Ni6	–	–	16N6	14Ni6	15Ni6	–	–	ASTM A350LF5	–
1.5662	X8Ni9	1501-509-510	–	–	X10Ni9	XBNI09	–	–	ASTM A353	–
1.5710	36NiCr6	640A35	111A	35NC6	–	–	–	SNC236	3135	–
1.5732	14NiCr10	–	–	14NC11	16NiCr11	15NiCr11	–	SNC415(H)	3415	–
1.5752	14NiCr14	655M13	36A	12NC15	–	–	–	SNC815(H)	3415, 3310	–
1.6523	21NiCrMo2	805M20	362	20NCD2	20NiCrMo2	20NiCrMo2	2506	SNCM220(H)	8620	–
1.6546	40NiCrMo22	311-Type 7	–	–	40NiCrMo2(KB)	40NiCrMo2	–	SNCM240	8740	–
1.6587	17CrNiMo6	820A16	–	18NCD6	–	14NiCrMo13	–	–	–	–
1.7015	15Cr3	523M15	–	12C3	–	–	–	SCr415(H)	5015	15Cr

Niemcy		Wielka Brytania		Francja	Włochy	Hiszpania	Szwecja	Japonia	USA	Chiny
W-nr.	DIN	BS	EN	AFNOR	UNI	UNE	SS	JIS	AISI/SAE	GB
1.7045	42Cr4	–	–	–	–	42Cr4	2245	SCr440	5140	40Cr
1.7176	55Cr3	527A60	48	55C3	–	–	–	SUP9(A)	5155	20CrMn
1.7262	15CrMo5	–	–	12CD4	–	12CrMo4	2216	SCM415(H)	–	–
1.7335	13CrMo4 4	1501-620Gr27	–	15CD3.5 15CD4.5	14CrMo45	14CrMo45	–	–	ASTM A182 F11, F12	–
1.7380	10CrMo910	1501-622 Gr31, 45	–	12CD9 12CD10	12CrMo9 12CrMo10	TU.H	2218	–	ASTM A182 F.22	–
1.7715	14MoV63	1503-660-440	–	–	–	13MoCrV6	–	–	–	–
1.8523	39CrMoV13 9	897M39	40C	–	36CrMoV12	–	–	–	–	–
1.6511	36CrNiMo4	816M40	110	40NCD3	38NiCrMo4(KB)	35NiCrMo4	–	–	9840	–
1.6582	34CrNiMo6	817M40	24	35NCD6	35NiCrMo6(KB)	–	2541	–	4340	40CrNiMoA
1.7033	34Cr4	530A32	18B	32C4	34Cr4(KB)	35Cr4	–	SCr430(H)	5132	35Cr
1.7035	41Cr4	530M40	18	42C4	41Cr4	42Cr4	–	SCr440(H)	5140	40Cr
1.7131	16MnCr5	(527M20)	–	16MC5	16MnCr5	16MnCr5	2511	–	5115	18CrMn
1.7218	25CrMo4	1717CDS110 708M20	–	25CD4	25CrMo4(KB)	55Cr3	2225	SCM420 SCM430	4130	30CrMn
1.7220	34CrMo4	708A37	19B	35CD4	35CrMo4	34CrMo4	2234	SCM432 SCCRM3	4137 4135	35CrMo
1.7223	41CrMo4	708M40	19A	42CD4TS	41CrMo4	42CrMo4	2244	SCM 440	4140 4142	40CrMoA
1.7225	42CrMo4	708M40	19A	42CD4	42CrMo4	42CrMo4	2244	SCM440(H)	4140	42CrMo 42CrMnMo
1.7361	32CrMo12	722M24	40B	30CD12	32CrMo12	F.124.A	2240	–	–	–
1.8159	50CrV4	735A50	47	50CV4	50CrV4	51CrV4	2230	SUP10	6150	50CrVA
1.8509	41CrAlMo7	905M39	41B	40CAD6 40CAD2	41CrAlMo7	41CrAlMo7	2940	–	–	–
1.2067	100Cr6	BL3	–	Y100C6	–	100Cr6	–	–	L3	CrV, 9SiCr
1.2419	105WCr6	–	–	105WC13	100WCr6 107WCr5KU	105WCr5	2140	SKS31 SKS2, SKS3	–	CrWMo
1.2713	55NiCrMoV6	BH224/5	–	55NCDV7	–	F.520.S	–	SKT4	L6	5CrNiMo
1.5662	X8Ni9	1501-509	–	–	X10Ni9	XBNI09	–	–	ASTM A353	–
1.5680	12Ni19	–	–	Z18N5	–	–	–	–	2515	–
1.6657	14NiCrMo134	832M13	36C	–	15NiCrMo13	14NiCrMo131	–	–	–	–
1.2080	X210Cr12	BD3	–	Z200C12	X210Cr13KU X250Cr12KU	X210Cr12	–	SKD1	D3 ASTM D3	Cr12
1.2601	X153CrMoV12	BD2	–	–	X160CrMoV12	–	–	SKD11	D2	Cr12MoV
1.2363	X100CrMoV5	BA2	–	Z100CDV5	X100CrMoV5	F.5227	2260	SKD12	A2	Cr5Mo1V
1.2344	X40CrMoV51 X40CrMoV51	BH13	–	Z40CDV5	X35CrMoV05KU X40CrMoV51KU	X40CrMoV5	2242	SKD61	H13 ASTM H13	40CrMoV5
1.2436	X210CrW12	–	–	–	X215CrW121KU	X210CrW12	2312	SKD2	–	–
1.2542	45WCrV7	BS1	–	–	45WCrV8KU	45WCrSi8	2710	–	S1	–
1.2581	X30WCrV93	BH21	–	Z30WCV9	X28W09KU	X30WCrV9	–	SKD5	H21	30WCrV9
1.2601	X165CrMoV12	–	–	–	X165CrMoV12KU	X160CrMoV12	2310	–	–	–
1.2833	100V1	BW2	–	Y1105V	–	–	–	SKS43	W210	V
1.3255	S 18-1-2-5	BT4	–	Z80WKCV	X78WCo1805KU	HS18-1-1-5	–	SKH3	T4	W18Cr4VCo5
1.3355	S 18-0-1	BT1	–	Z80WCV	X75W18KU	HS18-0-1	–	SKH2	T1	–
1.3401	G-X120Mn12	Z120M12	–	Z120M12	XG120Mn12	X120MN12	–	SCMnH/1	–	–
1.4718	X45CrSi93	401S45	52	Z45CS9	X45CrSi8	F.322	–	SUH1	HW3	X45CrSi93
1.3343	S6-5-2	4959BA2	–	Z40CSD10	15NiCrMo13	–	2715	SUH3	D3	–
1.3343	S6/5/2	BM2	–	Z85WDCV	HS6-5-2-2	F.5603	2722	SKH9, SKH51	M2	–
1.3348	S 2-9-2	–	–	–	HS2-9-2	HS2-9-2	2782	–	M7	–
1.3243	S6/5/2/5	BM35	–	6-5-2-5	HS6-5-2-5	F.5613	2723	SKH55	M35	–

TABELA PORÓWNAWCZA MATERIAŁÓW (METALE)

■ STAL NIERDZEWNA (FERRYTYCZNO, MARTENZYTYCZNA)

Niemcy		Wielka Brytania		Francja	Włochy	Hiszpania	Szwecja	Japonia	USA	Chiny
W-nr.	DIN	BS	EN	AFNOR	UNI	UNE	SS	JIS	AISI/SAE	GB
1.4000	X7Cr13	403S17	–	Z6C13	X6Cr13	F.3110	2301	SUS403	403	OCr13 1Cr12
1.4001	X7Cr14	–	–	–	–	F.8401	–	–	–	–
1.4005	X12CrS13	416S21	–	Z11CF13	X12CrS13	F.3411	2380	SUS416	416	–
1.4006	X10Cr13	410S21	56A	Z10C14	X12Cr13	F.3401	2302	SUS410	410	1Cr13
1.4016	X8Cr17	430S15	60	Z8C17	X8Cr17	F.3113	2320	SUS430	430	1Cr17
1.4027	G-X20Cr14	420C29	56B	Z20C13M	–	–	–	SCS2	–	–
1.4034	X46Cr13	420S45	56D	Z40CM Z38C13M	X40Cr14	F.3405	2304	SUS420J2	–	4Cr13
1.4003	–	405S17	–	Z8CA12	X6CrAl13	–	–	–	405	–
1.4021	–	420S37	–	Z8CA12	X20Cr13	–	2303	–	420	–
1.4057	X22CrNi17	431S29	57	Z15CNi6.02	X16CrNi16	F.3427	2321	SUS431	431	1Cr17Ni2
1.4104	X12CrMoS17	–	–	Z10CF17	X10CrS17	F.3117	2383	SUS430F	430F	Y1Cr17
1.4113	X6CrMo17	434S17	–	Z8CD17.01	X8CrMo17	–	2325	SUS434	434	1Cr17Mo
1.4313	X5CrNi134	425C11	–	Z4CND13.4M	(G)X6CrNi304	–	2385	SCS5	CA6-NM	–
1.4724	X10CrA113	403S17	–	Z10C13	X10CrA112	F.311	–	SUS405	405	OCr13Al
1.4742	X10CrA118	430S15	60	Z10CAS18	X8Cr17	F.3113	–	SUS430	430	Cr17
1.4747	X80CrNiSi20	443S65	59	Z80CSN20.02	X80CrSiNi20	F.320B	–	SUH4	HNV6	–
1.4762	X10CrA124	–	–	Z10CAS24	X16Cr26	–	2322	SUH446	446	2Cr25N
1.4871	X53CrMnNiN219	349S54	–	Z52CMN21.09	X53CrMnNiN219	–	–	SUH35	EV8	5Cr2Mn9Ni4N
1.4521	X1CrMoTi182	–	–	–	–	–	2326	–	S44400	–
1.4922	X20CrMoV12-1	–	–	–	X20CrMoNi1201	–	2317	–	–	–
1.4542	–	–	–	Z7CNU17-04	–	–	–	–	630	–

■ STAL NIERDZEWNA (AUSTENITYCZNA)

Niemcy		Wielka Brytania		Francja	Włochy	Hiszpania	Szwecja	Japonia	USA	Chiny
W-nr.	DIN	BS	EN	AFNOR	UNI	UNE	SS	JIS	AISI/SAE	GB
1.4306	X2CrNi1911	304S11	–	Z2CN18.10	X2CrNi18.11	–	2352	SUS304L	304L	OCr19Ni10
1.4350	X5CrNi189	304S11	58E	Z6CN18.09	X5CrNi1810	F.3551 F.3541 F.3504	2332	SUS304	304	OCr18Ni9
1.4305	X12CrNiS188	303S21	58M	Z10CNF18.09	X10CrNiS18.09	F.3508	2346	SUS303	303	1Cr18Ni9MoZr
–	–	304C12	–	Z3CN19.10	–	–	2333	SUS304L	–	–
1.4306	X2CrNi189	304S12	–	Z2CrNi1810	X2CrNi18.11	F.3503	2352	SCS19	304L	–
1.4310	X12CrNi177	–	–	Z12CN17.07	X12CrNi1707	F.3517	2331	SUS301	301	Cr17Ni7
1.4311	X2CrNiN1810	304S62	–	Z2CN18.10	–	–	2371	SUS304LN	304LN	–
1.4401	X5CrNiMo1810	316S16	58J	Z6CND17.11	X5CrNiMo1712	F.3543	2347	SUS316	316	OCr17Ni11Mo2
1.4308	G-X6CrNi189	304C15	–	Z6CN18.10M	–	–	–	SCS13	–	–
1.4408	G-X6CrNiMo1810	316C16	–	–	–	F.8414	–	SCS14	–	–
1.4581	G-X5CrNiMoNb1810	318C17	–	Z4CNDNb1812M	XG8CrNiMo1811	–	–	SCS22	–	–
1.4429	X2CrNiMoN1813	–	–	Z2CND17.13	–	–	2375	SUS316LN	316LN	OCr17Ni13Mo
1.4404	–	316S13	–	Z2CND17.12	X2CrNiMo1712	–	2348	–	316L	–
1.4435	X2CrNiMo1812	316S13	–	Z2CND17.12	X2CrNiMo1712	–	2353	SCS16 SUS316L	316L	OCr27Ni12Mo3
1.4436	–	316S13	–	Z6CND18-12-03	X8CrNiMo1713	–	2343, 2347	–	316	–
1.4438	X2CrNiMo1816	317S12	–	Z2CND19.15	X2CrNiMo1816	–	2367	SUS317L	317L	OCr19Ni13Mo
1.4539	X1NiCrMo	–	–	Z6CNT18.10	–	–	2562	–	UNS V 0890A	–
1.4541	X10CrNiTi189	321S12	58B	Z6CNT18.10	X6CrNiTi1811	F.3553 F.3523	2337	SUS321	321	1Cr18Ni9Ti
1.4550	X10CrNiNb189	347S17	58F	Z6CNNb18.10	X6CrNiNb1811	F.3552 F.3524	2338	SUS347	347	1Cr18Ni11Nb
1.4571	X10CrNiMoTi1810	320S17	58J	Z6CNDT17.12	X6CrNiMoTi1712	F.3535	2350	–	316Ti	Cr18Ni12Mo2T
1.4583	X10CrNiMoNb1812	–	–	Z6CNDNb1713B	X6CrNiMoNb1713	–	–	–	318	Cr17Ni12Mo3Mb

Niemcy		Wielka Brytania		Francja	Włochy	Hiszpania	Szwecja	Japonia	USA	Chiny
W-nr.	DIN	BS	EN	AFNOR	UNI	UNE	SS	JIS	AISI/SAE	GB
1.4828	X15CrNiSi2012	309S24	–	Z15CNS20.12	X6CrNi2520	–	–	SUH309	309	1Cr23Ni13
1.4845	X12CrNi2521	310S24	–	Z12CN2520	X6CrNi2520	F.331	2361	SUH310	310S	OCr25Ni20
1.4406	X10CrNi18.08	–	58C	Z1NCDU25.20	–	F.8414	2370	SCS17	308	–
1.4418	X4CrNiMo165	–	–	Z6CND16-04-01	–	–	–	–	–	–
1.4568	–	316S111	–	Z8CNA17-07	X2CrNiMo1712	–	–	–	17-7PH	–
1.4504	–	–	–	–	–	–	–	–	–	–
1.4563	–	–	–	Z1NCDU31-27-03 Z1CNDU20-18-06AZ	–	–	2584 2378	–	NO8028 S31254	–
1.4878	X12CrNiTi189	321S32	58B, 58C	Z6CNT18.12B	X6CrNiTi18.11	F.3523	–	SUS321	321	1Cr18Ni9Ti

■ STALE ŻAROODPORNE

Niemcy		Wielka Brytania		Francja	Włochy	Hiszpania	Szwecja	Japonia	USA	Chiny
W-nr.	DIN	BS	EN	AFNOR	UNI	UNE	SS	JIS	AISI/SAE	GB
1.4864	X12NiCrSi3616	–	–	Z12NCS35.16	–	–	–	SUH330	330	–
1.4865	G-X40NiCrSi3818	330C11	–	–	XG50NiCr3919	–	–	SCH15	HT, HT 50	–

■ ŻELIWO SZARE

Niemcy		Wielka Brytania		Francja	Włochy	Hiszpania	Szwecja	Japonia	USA	Chiny
W-nr.	DIN	BS	EN	AFNOR	UNI	UNE	SS	JIS	AISI/SAE	GB
–	–	–	–	–	–	–	0100	–	–	–
–	GG 10	–	–	Ft 10 D	–	–	0110	FC100	No 20 B	–
0.6015	GG 15	Grade 150	–	Ft 15 D	G15	FG15	0115	FC150	No 25 B	HT150
0.6020	GG 20	Grade 220	–	Ft 20 D	G20	–	0120	FC200	No 30 B	HT200
0.6025	GG 25	Grade 260	–	Ft 25 D	G25	FG25	0125	FC250	No 35 B	HT250
–	–	–	–	–	–	–	–	–	No 40 B	–
0.6030	GG 30	Grade 300	–	Ft 30 D	G30	FG30	0130	FC300	No 45 B	HT300
0.6035	GG 35	Grade 350	–	Ft 35 D	G35	FG35	0135	FC350	No 50 B	HT350
0.6040	GG 40	Grade 400	–	Ft 40 D	–	–	0140	–	No 55 B	HT400
0.6660	GGL NiCr202	L-NiCuCr202	–	L-NC 202	–	–	0523	–	A436 Type 2	–

■ ŻELIWO SFEROIDALNE (GGG)

Niemcy		Wielka Brytania		Francja	Włochy	Hiszpania	Szwecja	Japonia	USA	Chiny
W-nr.	DIN	BS	EN	AFNOR	UNI	UNE	SS	JIS	AISI/SAE	GB
0.7040	GGG 40	SNG 420/12	–	FCS 400-12	GS 370-17	FGE 38-17	07 17-02	FCD400	60-40-18	QT400-18
–	GGG 40.3	SNG 370/17	–	FGS 370-17	–	–	07 17-12	–	–	–
0.7033	GGG 35.3	–	–	–	–	–	07 17-15	–	–	–
0.7050	GGG 50	SNG 500/7	–	FGS 500-7	GS 500	FGE 50-7	07 27-02	FCD500	80-55-06	QT500-7
0.7660	GGG NiCr202	Grade S6	–	S-NC202	–	–	07 76	–	A43D2	–
–	GGG NiMn137	L-NiMn 137	–	L-MN 137	–	–	07 72	–	–	–
–	GGG 60	SNG 600/3	–	FGS 600-3	–	–	07 32-03	FCD600	–	QT600-3
0.7070	GGG 70	SNG 700/2	–	FGS 700-2	GS 700-2	FGS 70-2	07 37-01	FCD700	100-70-03	QT700-18

■ ŻELIWO CIĄGLIWE (GT)

Niemcy		Wielka Brytania		Francja	Włochy	Hiszpania	Szwecja	Japonia	USA	Chiny
W-nr.	DIN	BS	EN	AFNOR	UNI	UNE	SS	JIS	AISI/SAE	GB
–	–	8 290/6	–	MN 32-8	–	–	08 14	FCMB310	–	–
–	GTS-35	B 340/12	–	MN 35-10	–	–	08 15	FCMW330	32510	–
0.8145	GTS-45	P 440/7	–	Mn 450	GMN45	–	08 52	FCMW370	40010	–
0.8155	GTS-55	P 510/4	–	MP 50-5	GMN55	–	08 54	FCMP490	50005	–
–	GTS-65	P 570/3	–	MP 60-3	–	–	08 58	FCMP540	70003	–
0.8165	GTS-65-02	P 570/3	–	Mn 650-3	GMN 65	–	08 56	FCMP590	A220-70003	–
–	GTS-70-02	P 690/2	–	Mn 700-2	GMN 70	–	08 62	FCMP690	A220-80002	–

CHROPOWATOŚĆ POWIERZCHNI

CHROPOWATOŚĆ POWIERZCHNI

(Wg normy JIS B 0601-1994)

Typ	Symbol literowy	Sposób oznaczania	Przykład oznaczania (rysunek)
Srednie arytmetyczne odchylenie profilu chropowatosci	Ra	<p>Ra oznacza wartość obliczoną z poniższego wzoru i wyrażoną w mikrometrach (μm), w oparciu o wyniki pomiarów profilu chropowatości na długości odcinka elementarnego w kierunku linii średniej. Oś X pokrywa się z kierunkiem linii średniej a oś Y biegnie w kierunku prostopadłym (powiększenia). Krzywa chropowatości jest wyrażona wzorem $y=f(x)$:</p> $Ra = \frac{1}{l} \int_0^l f(x) dx$	
Maks. wysokość nierówności	Rz	<p>Rmax oznacza się jako odległość pomiędzy linią wzniesień a linią wgłębień profilu chropowatości mierzoną w kierunku prostopadłym do linii średniej w przedziale odcinka elementarnego. Otrzymana wartość jest wyrażona w mikrometrach (μm). Uwaga) Podczas oznaczania Rmax, jako odcinek elementarny przyjmuje się część profilu niezawierającą wyjątkowo wysokich wzniesień lub wyjątkowo niskich wgłębień (który może być uważany za wadę).</p> $Rz = R_p + R_v$	
Chropowatosc wedlug dziesieciu punktow profilu	RzJIS	<p>Rz oznacza się jako średnią arytmetyczną wartości bezwzględnych wysokości pięciu najwyższych wzniesień (Y_p) i głębokości pięciu najniższych wgłębień (Y_v) profilu chropowatości mierzoną w kierunku prostopadłym do linii średniej, w przedziale odcinka elementarnego, wyrażoną w mikrometrach (μm).</p> $Rz_{JIS} = \frac{(Y_{p1} + Y_{p2} + Y_{p3} + Y_{p4} + Y_{p5}) + (Y_{v1} + Y_{v2} + Y_{v3} + Y_{v4} + Y_{v5})}{5}$	<p>$Y_{p1}, Y_{p2}, Y_{p3}, Y_{p4}, Y_{p5}$:Wysokości pięciu najwyższych wzniesień profilu chropowatości w przedziale odcinka elementarnego o długości l.</p> <p>$Y_{v1}, Y_{v2}, Y_{v3}, Y_{v4}, Y_{v5}$:Wysokości pięciu najniższych wgłębień profilu chropowatości w przedziale odcinka elementarnego l.</p>

INFORMACJE TECHNICZNE

ZALEŻNOŚĆ MIĘDZY ŚREDNIM ARYTMETYCZNYM ODCHYLENIEM PROFILU CHROPOWATOŚCI (Ra) A POMIARAMI KONWENCJONALNYMI (DANE PORÓWNAWCZE)

Średnie arytmetyczne odchylenie profilu chropowatości		Maksymalna wysokość nierówności	Chropowatosc wedlug dziesieciu punktow profilu		Odcinek elementarny dla pomiarów Rz • RzJIS l (mm)	Oznakowanie chropowatości
Ra		Rz	RzJIS			
Szereg znormalizowany	Wartość granicznej długości fali filtru chropowatości "Cut-off" λc (mm)	Szereg znormalizowany				
0.012 a	0.08	0.05s	0.05z		0.08	▽▽▽▽
0.025 a		0.1 s	0.1 z			
0.05 a	0.25	0.2 s	0.2 z		0.25	▽▽▽▽
0.1 a		0.4 s	0.4 z			
0.2 a		0.8 s	0.8 z			
0.4 a		1.6 s	1.6 z			
0.8 a	0.8	3.2 s	3.2 z		0.8	▽▽▽
1.6 a		6.3 s	6.3 z			
3.2 a		12.5 s	12.5 z			
6.3 a	2.5	25 s	25 z		2.5	▽▽
12.5 a		50 s	50 z			
25 a	8	100 s	100 z		8	▽
50 a		200 s	200 z			
100 a		400 s	400 z			

*Porównanie pomiędzy tymi trzema parametrami chropowatości przedstawiono dla wygody, nie jest ono dokładne.

*Ra: Odcinek pomiarowy dla pomiarów Rmax i Rz to odpowiednio 5-krotność wartości granicznej długości fali filtru chropowatości "cut-off" i odcinka elementarnego.

TABELA PORÓWNAWCZA TWARDOŚCI

TABELA PORÓWNAWCZA TWARDOŚCI STALI

Twardość Brinella (HB), kuli o średnicy 10mm, nacisk: 3000KG		Twardość Vickersa	Twardość Rockwella				Twardość Shore a	Wytrzymałość na rozciąganie (w przybliżeniu) MPa	Twardość Brinella (HB), kuli o średnicy 10mm, nacisk: 3000KG		Twardość Vickersa	Twardość Rockwella				Twardość Shore a	Wytrzymałość na rozciąganie (w przybliżeniu) MPa
Znormalizowany węgliak w kształcie kulki	Kulka z węglika wolframu		Skala A, nacisk: 60KG, Węgliak diamentowy	Skala B, nacisk: 100KG, 1/16" Frezy kuliste	Skala C, nacisk: 150KG, Węgliak diamentowy	Skala D, nacisk: 100KG, Węgliak diamentowy			Znormalizowany węgliak w kształcie kulki	Kulka z węglika wolframu		Skala A, nacisk: 60KG, Węgliak diamentowy	Skala B, nacisk: 100KG, 1/16" Frezy kuliste	Skala C, nacisk: 150KG, Węgliak diamentowy	Skala D, nacisk: 100KG, Węgliak diamentowy		
(HV)	(HRA)	(HRB)	(HRC)	(HRD)	(HS)	(HV)	(HRA)	(HRB)	(HRC)	(HRD)	(HS)	(HV)	(HRA)	(HRB)	(HRC)	(HRD)	(HS)
—	—	940	85.6	—	68.0	76.9	97	—	429	429	455	73.4	—	45.7	59.7	61	1510
—	—	920	85.3	—	67.5	76.5	96	—	415	415	440	72.8	—	44.5	58.8	59	1460
—	—	900	85.0	—	67.0	76.1	95	—	401	401	425	72.0	—	43.1	57.8	58	1390
—	(767)	880	84.7	—	66.4	75.7	93	—	388	388	410	71.4	—	41.8	56.8	56	1330
—	(757)	860	84.4	—	65.9	75.3	92	—	375	375	396	70.6	—	40.4	55.7	54	1270
—	(745)	840	84.1	—	65.3	74.8	91	—	363	363	383	70.0	—	39.1	54.6	52	1220
—	(733)	820	83.8	—	64.7	74.3	90	—	352	352	372	69.3	(110.0)	37.9	53.8	51	1180
—	(722)	800	83.4	—	64.0	73.8	88	—	341	341	360	68.7	(109.0)	36.6	52.8	50	1130
—	(712)	—	—	—	—	—	—	—	331	331	350	68.1	(108.5)	35.5	51.9	48	1095
—	(710)	780	83.0	—	63.3	73.3	87	—	321	321	339	67.5	(108.0)	34.3	51.0	47	1060
—	(698)	760	82.6	—	62.5	72.6	86	—	—	—	—	—	—	—	—	—	—
—	(684)	740	82.2	—	61.8	72.1	—	—	311	311	328	66.9	(107.5)	33.1	50.0	46	1025
—	(682)	737	82.2	—	61.7	72.0	84	—	302	302	319	66.3	(107.0)	32.1	49.3	45	1005
—	(670)	720	81.8	—	61.0	71.5	83	—	293	293	309	65.7	(106.0)	30.9	48.3	43	970
—	(656)	700	81.3	—	60.1	70.8	—	—	285	285	301	65.3	(105.5)	29.9	47.6	—	950
—	(653)	697	81.2	—	60.0	70.7	81	—	277	277	292	64.6	(104.5)	28.8	46.7	41	925
—	(647)	690	81.1	—	59.7	70.5	—	—	269	269	284	64.1	(104.0)	27.6	45.9	40	895
—	(638)	680	80.8	—	59.2	70.1	80	—	262	262	276	63.6	(103.0)	26.6	45.0	39	875
—	630	670	80.6	—	58.8	69.8	—	—	255	255	269	63.0	(102.0)	25.4	44.2	38	850
—	627	667	80.5	—	58.7	69.7	79	—	248	248	261	62.5	(101.0)	24.2	43.2	37	825
—	—	—	—	—	—	—	—	—	241	241	253	61.8	100	22.8	42.0	36	800
—	—	677	80.7	—	59.1	70.0	—	—	—	—	—	—	—	—	—	—	—
—	601	640	79.8	—	57.3	68.7	77	—	235	235	247	61.4	99.0	21.7	41.4	35	785
—	—	—	—	—	—	—	—	—	229	229	241	60.8	98.2	20.5	40.5	34	765
—	—	640	79.8	—	57.3	68.7	—	—	223	223	234	—	97.3	(18.8)	—	—	—
—	578	615	79.1	—	56.0	67.7	75	—	217	217	228	—	96.4	(17.5)	—	33	725
—	—	—	—	—	—	—	—	—	212	212	222	—	95.5	(16.0)	—	—	705
—	—	607	78.8	—	55.6	67.4	—	—	—	—	—	—	—	—	—	—	—
—	555	591	78.4	—	54.7	66.7	73	2055	207	207	218	—	94.6	(15.2)	—	32	690
—	—	—	—	—	—	—	—	—	201	201	212	—	93.8	(13.8)	—	31	675
—	—	579	78.0	—	54.0	66.1	—	2015	197	197	207	—	92.8	(12.7)	—	30	655
—	534	569	77.8	—	53.5	65.8	71	1985	192	192	202	—	91.9	(11.5)	—	29	640
—	—	—	—	—	—	—	—	—	187	187	196	—	90.7	(10.0)	—	—	620
—	—	533	77.1	—	52.5	65.0	—	1915	—	—	—	—	—	—	—	—	—
—	514	547	76.9	—	52.1	64.7	70	1890	183	183	192	—	90.0	(9.0)	—	28	615
—	—	—	—	—	—	—	—	—	179	179	188	—	89.0	(8.0)	—	27	600
(495)	—	539	76.7	—	51.6	64.3	—	1855	174	174	182	—	87.8	(6.4)	—	—	585
—	—	530	76.4	—	51.1	63.9	—	1825	170	170	178	—	86.8	(5.4)	—	26	570
—	495	528	76.3	—	51.0	63.8	68	1820	167	167	175	—	86.0	(4.4)	—	—	560
(477)	—	516	75.9	—	50.3	63.2	—	1780	163	163	171	—	85.0	(3.3)	—	25	545
—	—	508	75.6	—	49.6	62.7	—	1740	156	156	163	—	82.9	(0.9)	—	—	525
—	477	508	75.6	—	49.6	62.7	66	1740	149	149	156	—	80.8	—	—	23	505
—	—	—	—	—	—	—	—	—	143	143	150	—	78.7	—	—	22	490
(461)	—	495	75.1	—	48.8	61.9	—	1680	137	137	143	—	76.4	—	—	21	460
—	—	491	74.9	—	48.5	61.7	—	1670	—	—	—	—	—	—	—	—	—
—	461	491	74.9	—	48.5	61.7	65	1670	131	131	137	—	74.0	—	—	—	450
—	—	—	—	—	—	—	—	—	126	126	132	—	72.0	—	—	20	435
444	—	474	74.3	—	47.2	61.0	—	1595	121	121	127	—	69.8	—	—	19	415
—	—	472	74.2	—	47.1	60.8	—	1585	116	116	122	—	67.6	—	—	18	400
—	444	472	74.2	—	47.1	60.8	63	1585	111	111	117	—	65.7	—	—	15	385

Uwaga 1) Powyższa lista jest identyczna z listą AMS Metals Handbook. Wytrzymałość na rozciąganie podano w jednostkach metrycznych a twardość Brinella podano tylko dla zalecanego zakresu.

Uwaga 2) 1MPa=1N/mm²

Uwaga 3) Liczby w nawiasach okrągłych () są rzadko stosowane i podano je głównie dla celów porównawczych. Listę opracowano w oparciu o podręcznik JIS Handbook Steel I.

P

INFORMACJE TECHNICZNE

POLA TOLERANCJI OTWORÓW

Wymiar nominalny (mm)		Odchyłki wymiarów nominalnych otworów dla poszczególnych klas tolerancji															
>	≤	B10	C9	C10	D8	D9	D10	E7	E8	E9	F6	F7	F8	G6	G7	H6	H7
-	3	+180	+85	+100	+34	+45	+60	+24	+28	+39	+12	+16	+20	+8	+12	+6	+10
		+140	+60	+60	+20	+20	+20	+14	+14	+14	+6	+6	+6	+2	+2	0	0
3	6	+188	+100	+118	+48	+60	+78	+32	+38	+50	+18	+22	+28	+12	+16	+8	+12
		+140	+70	+70	+30	+30	+30	+20	+20	+20	+10	+10	+10	+4	+4	0	0
6	10	+208	+116	+138	+62	+76	+98	+40	+47	+61	+22	+28	+35	+14	+20	+9	+15
		+150	+80	+80	+40	+40	+40	+25	+25	+25	+13	+13	+13	+5	+5	0	0
10	14	+220	+138	+165	+77	+93	+120	+50	+59	+75	+27	+34	+43	+17	+24	+11	+18
		+150	+95	+95	+50	+50	+50	+32	+32	+32	+16	+16	+16	+6	+6	0	0
14	18	+244	+162	+194	+98	+117	+149	+61	+73	+92	+33	+41	+53	+20	+28	+13	+21
		+160	+110	+110	+65	+65	+65	+40	+40	+40	+20	+20	+20	+7	+7	0	0
18	24	+270	+182	+220	+119	+142	+180	+75	+89	+112	+41	+50	+64	+25	+34	+16	+25
		+170	+120	+120	+80	+80	+80	+50	+50	+50	+25	+25	+25	+9	+9	0	0
30	40	+280	+192	+230	+146	+174	+220	+90	+106	+134	+49	+60	+76	+29	+40	+19	+30
		+180	+130	+130	+100	+100	+100	+60	+60	+60	+30	+30	+30	+10	+10	0	0
40	50	+310	+214	+260	+174	+207	+260	+107	+126	+159	+58	+71	+90	+34	+47	+22	+35
		+190	+140	+140	+120	+120	+120	+72	+72	+72	+36	+36	+36	+12	+12	0	0
50	65	+320	+224	+270	+208	+245	+305	+125	+148	+185	+68	+83	+106	+39	+54	+25	+40
		+200	+150	+150	+145	+145	+145	+85	+85	+85	+43	+43	+43	+14	+14	0	0
65	80	+360	+257	+310	+242	+285	+355	+146	+172	+215	+79	+96	+122	+44	+61	+29	+46
		+220	+170	+170	+170	+170	+170	+100	+100	+100	+50	+50	+50	+15	+15	0	0
80	100	+380	+267	+320	+271	+320	+400	+162	+191	+240	+88	+108	+137	+49	+69	+32	+52
		+240	+180	+180	+190	+190	+190	+110	+110	+110	+56	+56	+56	+17	+17	0	0
100	120	+420	+300	+360	+299	+350	+440	+182	+214	+265	+98	+119	+151	+54	+75	+36	+57
		+260	+200	+200	+210	+210	+210	+125	+125	+125	+62	+62	+62	+18	+18	0	0
120	140	+440	+310	+370	+327	+385	+480	+198	+232	+290	+108	+131	+165	+60	+83	+40	+63
		+280	+210	+210	+230	+230	+230	+135	+135	+135	+68	+68	+68	+20	+20	0	0
140	160	+470	+330	+390	+299	+350	+440	+182	+214	+265	+98	+119	+151	+54	+75	+36	+57
		+310	+230	+230	+210	+210	+210	+125	+125	+125	+62	+62	+62	+18	+18	0	0
160	180	+525	+355	+425	+327	+385	+480	+198	+232	+290	+108	+131	+165	+60	+83	+40	+63
		+340	+240	+240	+230	+230	+230	+135	+135	+135	+68	+68	+68	+20	+20	0	0
180	200	+565	+375	+445	+299	+350	+440	+182	+214	+265	+98	+119	+151	+54	+75	+36	+57
		+380	+260	+260	+210	+210	+210	+125	+125	+125	+62	+62	+62	+18	+18	0	0
200	225	+605	+395	+465	+299	+350	+440	+182	+214	+265	+98	+119	+151	+54	+75	+36	+57
		+420	+280	+280	+210	+210	+210	+125	+125	+125	+62	+62	+62	+18	+18	0	0
225	250	+690	+430	+510	+327	+385	+480	+198	+232	+290	+108	+131	+165	+60	+83	+40	+63
		+480	+300	+300	+230	+230	+230	+135	+135	+135	+68	+68	+68	+20	+20	0	0
250	280	+750	+460	+540	+327	+385	+480	+198	+232	+290	+108	+131	+165	+60	+83	+40	+63
		+540	+330	+330	+230	+230	+230	+135	+135	+135	+68	+68	+68	+20	+20	0	0
280	315	+830	+500	+590	+327	+385	+480	+198	+232	+290	+108	+131	+165	+60	+83	+40	+63
		+600	+360	+360	+230	+230	+230	+135	+135	+135	+68	+68	+68	+20	+20	0	0
315	355	+910	+540	+630	+299	+350	+440	+182	+214	+265	+98	+119	+151	+54	+75	+36	+57
		+680	+400	+400	+210	+210	+210	+125	+125	+125	+62	+62	+62	+18	+18	0	0
355	400	+1010	+595	+690	+327	+385	+480	+198	+232	+290	+108	+131	+165	+60	+83	+40	+63
		+760	+440	+440	+230	+230	+230	+135	+135	+135	+68	+68	+68	+20	+20	0	0
400	450	+1090	+635	+730	+327	+385	+480	+198	+232	+290	+108	+131	+165	+60	+83	+40	+63
		+840	+480	+480	+230	+230	+230	+135	+135	+135	+68	+68	+68	+20	+20	0	0

Uwaga 1) Wartości podane u góry odpowiedniego pola oznaczają odchyłkę górną a wartości podane u dołu oznaczają odchyłkę dolną.

P

INFORMACJE TECHNICZNE

Odchyłki wymiarów nominalnych otworów dla poszczególnych klas tolerancji

H8	H9	H10	JS6	JS7	K6	K7	M6	M7	N6	N7	P6	P7	R7	S7	T7	U7	X7
+14 0	+25 0	+40 0	± 3	± 5	0 -6	0 -10	-2 -8	-2 -12	-4 -10	-4 -14	-6 -12	-6 -16	-10 -20	-14 -24	-	-18 -28	-20 -30
+18 0	+30 0	+48 0	± 4	± 6	+2 -6	+3 -9	-1 -9	0 -12	-5 -13	-4 -16	-9 -17	-8 -20	-11 -23	-15 -27	-	-19 -31	-24 -36
+22 0	+36 0	+58 0	± 4.5	± 7	+2 -7	+5 -10	-3 -12	0 -15	-7 -16	-4 -19	-12 -21	-9 -24	-13 -28	-17 -32	-	-22 -37	-28 -43
+27 0	+43 0	+70 0	± 5.5	± 9	+2 -9	+6 -12	-4 -15	0 -18	-9 -20	-5 -23	-15 -26	-11 -29	-16 -34	-21 -39	-	-26 -44	-33 -51 -56
+33 0	+52 0	+84 0	± 6.5	± 10	+2 -11	+6 -15	-4 -17	0 -21	-11 -24	-7 -28	-18 -31	-14 -35	-20 -41	-27 -48	-	-33 -54	-46 -67 -77
+39 0	+62 0	+100 0	± 8	± 12	+3 -13	+7 -18	-4 -20	0 -25	-12 -28	-8 -33	-21 -37	-17 -42	-25 -50	-34 -59	-	-39 -64 -70	-51 -76 -86
+46 0	+74 0	+120 0	± 9.5	± 15	+4 -15	+9 -21	-5 -24	0 -30	-14 -33	-9 -39	-26 -45	-21 -51	-30 -60 -62	-42 -72 -78	-55 -85 -94	-76 -106 -121	-
+54 0	+87 0	+140 0	± 11	± 17	+4 -18	+10 -25	-6 -28	0 -35	-16 -38	-10 -45	-30 -52	-24 -59	-38 -73 -81	-58 -93 -101	-78 -113 -126	-111 -146 -166	-
+63 0	+100 0	+160 0	± 12.5	± 20	+4 -21	+12 -28	-8 -33	0 -40	-20 -45	-12 -52	-36 -61	-28 -68	-48 -88 -90 -93	-77 -117 -125 -133	-107 -147 -159 -171	-	-
+72 0	+115 0	+185 0	± 14.5	± 23	+5 -24	+13 -33	-8 -37	0 -46	-22 -51	-14 -60	-41 -70	-33 -79	-60 -109 -113	-105 -151 -159 -169	-	-	-
+81 0	+130 0	+210 0	± 16	± 26	+5 -27	+16 -36	-9 -41	0 -52	-25 -57	-14 -66	-47 -79	-36 -88	-74 -126 -130	-	-	-	-
+89 0	+140 0	+230 0	± 18	± 28	+7 -29	+17 -40	-10 -46	0 -57	-26 -62	-16 -73	-51 -87	-41 -98	-87 -144 -150	-	-	-	-
+97 0	+155 0	+250 0	± 20	± 31	+8 -32	+18 -45	-10 -50	0 -63	-27 -67	-17 -80	-55 -95	-45 -108	-103 -166 -172	-	-	-	-

POLA TOLERANCJI WAŁKÓW

Wymiar nominalny (mm)		Odchyłki wymiarów nominalnych wałków dla poszczególnych klas tolerancji														
>	≤	b9	c9	d8	d9	e7	e8	e9	f6	f7	f8	g5	g6	h5	h6	h7
-	3	-140	-60	-20	-20	-14	-14	-14	-6	-6	-6	-2	-2	0	0	0
		-165	-85	-34	-45	-24	-28	-39	-12	-16	-20	-6	-8	-4	-6	-10
3	6	-140	-70	-30	-30	-20	-20	-20	-10	-10	-10	-4	-4	0	0	0
		-170	-100	-48	-60	-32	-38	-50	-18	-22	-28	-9	-12	-5	-8	-12
6	10	-150	-80	-40	-40	-25	-25	-25	-13	-13	-13	-5	-5	0	0	0
		-186	-116	-62	-76	-40	-47	-61	-22	-28	-35	-11	-14	-6	-9	-15
10	14	-150	-95	-50	-50	-32	-32	-32	-16	-16	-16	-6	-6	0	0	0
		-193	-138	-77	-93	-50	-59	-75	-27	-34	-43	-14	-17	-8	-11	-18
14	18	-150	-95	-50	-50	-32	-32	-32	-16	-16	-16	-6	-6	0	0	0
		-193	-138	-77	-93	-50	-59	-75	-27	-34	-43	-14	-17	-8	-11	-18
18	24	-160	-110	-65	-65	-40	-40	-40	-20	-20	-20	-7	-7	0	0	0
		-212	-162	-98	-117	-61	-73	-92	-33	-41	-53	-16	-20	-9	-13	-21
24	30	-160	-110	-65	-65	-40	-40	-40	-20	-20	-20	-7	-7	0	0	0
		-212	-162	-98	-117	-61	-73	-92	-33	-41	-53	-16	-20	-9	-13	-21
30	40	-170	-120	-80	-80	-50	-50	-50	-25	-25	-25	-9	-9	0	0	0
		-232	-182	-119	-142	-75	-89	-112	-41	-50	-64	-20	-25	-11	-16	-25
40	50	-180	-130	-119	-142	-75	-89	-112	-41	-50	-64	-20	-25	-11	-16	-25
		-242	-192	-119	-142	-75	-89	-112	-41	-50	-64	-20	-25	-11	-16	-25
50	65	-190	-140	-100	-100	-60	-60	-60	-30	-30	-30	-10	-10	0	0	0
		-264	-214	-100	-100	-60	-60	-60	-30	-30	-30	-10	-10	0	0	0
65	80	-200	-150	-146	-174	-90	-106	-134	-49	-60	-76	-23	-29	-13	-19	-30
		-274	-224	-146	-174	-90	-106	-134	-49	-60	-76	-23	-29	-13	-19	-30
80	100	-220	-170	-120	-120	-72	-72	-72	-36	-36	-36	-12	-12	0	0	0
		-307	-257	-120	-120	-72	-72	-72	-36	-36	-36	-12	-12	0	0	0
100	120	-240	-180	-174	-207	-107	-126	-159	-58	-71	-90	-27	-34	-15	-22	-35
		-327	-267	-174	-207	-107	-126	-159	-58	-71	-90	-27	-34	-15	-22	-35
120	140	-260	-200	-145	-145	-85	-85	-85	-43	-43	-43	-14	-14	0	0	0
		-360	-300	-145	-145	-85	-85	-85	-43	-43	-43	-14	-14	0	0	0
140	160	-280	-210	-208	-245	-125	-148	-185	-68	-83	-106	-32	-39	-18	-25	-40
		-380	-310	-208	-245	-125	-148	-185	-68	-83	-106	-32	-39	-18	-25	-40
160	180	-310	-230	-208	-245	-125	-148	-185	-68	-83	-106	-32	-39	-18	-25	-40
		-410	-330	-208	-245	-125	-148	-185	-68	-83	-106	-32	-39	-18	-25	-40
180	200	-340	-240	-170	-170	-100	-100	-100	-50	-50	-50	-15	-15	0	0	0
		-455	-355	-170	-170	-100	-100	-100	-50	-50	-50	-15	-15	0	0	0
200	225	-380	-260	-242	-285	-146	-172	-215	-79	-96	-122	-35	-44	-20	-29	-46
		-495	-375	-242	-285	-146	-172	-215	-79	-96	-122	-35	-44	-20	-29	-46
225	250	-420	-280	-242	-285	-146	-172	-215	-79	-96	-122	-35	-44	-20	-29	-46
		-535	-395	-242	-285	-146	-172	-215	-79	-96	-122	-35	-44	-20	-29	-46
250	280	-480	-300	-190	-190	-110	-110	-110	-56	-56	-56	-17	-17	0	0	0
		-610	-430	-190	-190	-110	-110	-110	-56	-56	-56	-17	-17	0	0	0
280	315	-540	-330	-271	-320	-162	-191	-240	-88	-108	-137	-40	-49	-23	-32	-52
		-670	-460	-271	-320	-162	-191	-240	-88	-108	-137	-40	-49	-23	-32	-52
315	355	-600	-360	-210	-210	-125	-125	-125	-62	-62	-62	-18	-18	0	0	0
		-740	-500	-210	-210	-125	-125	-125	-62	-62	-62	-18	-18	0	0	0
355	400	-680	-400	-299	-350	-182	-214	-265	-98	-119	-151	-43	-54	-25	-36	-57
		-820	-540	-299	-350	-182	-214	-265	-98	-119	-151	-43	-54	-25	-36	-57
400	450	-760	-440	-230	-230	-135	-135	-135	-68	-68	-68	-20	-20	0	0	0
		-915	-595	-230	-230	-135	-135	-135	-68	-68	-68	-20	-20	0	0	0
450	500	-840	-480	-327	-385	-198	-232	-290	-108	-131	-165	-47	-60	-27	-40	-63
		-995	-635	-327	-385	-198	-232	-290	-108	-131	-165	-47	-60	-27	-40	-63

Uwaga 1) Wartości podane u góry odpowiedniego pola oznaczają odchyłkę górną a wartości podane u dołu oznaczają odchyłkę dolną.

P

INFORMACJE TECHNICZNE

Odchyłki wymiarów nominalnych wałków dla poszczególnych klas tolerancji

h8	h9	js5	js6	js7	k5	k6	m5	m6	n6	p6	r6	s6	t6	u6	x6
0 -14	0 -25	± 2	± 3	± 5	+4 0	+6 0	+6 +2	+8 +2	+10 +4	+12 +6	+16 +10	+20 +14	—	+24 +18	+26 +20
0 -18	0 -30	± 2.5	± 4	± 6	+6 +1	+9 +1	+9 +4	+12 +4	+16 +8	+20 +12	+23 +15	+27 +19	—	+31 +23	+36 +28
0 -22	0 -36	± 3	± 4.5	± 7	+7 +1	+10 +1	+12 +6	+15 +6	+19 +10	+24 +15	+28 +19	+32 +23	—	+37 +28	+43 +34
0 -27	0 -43	± 4	± 5.5	± 9	+9 +1	+12 +1	+15 +7	+18 +7	+23 +12	+29 +18	+34 +23	+39 +28	—	+44 +33	+51 +40 +56 +45
0 -33	0 -52	± 4.5	± 6.5	± 10	+11 +2	+15 +2	+17 +8	+21 +8	+28 +15	+35 +22	+41 +28	+48 +35	— +54 +41	+54 +61 +48	+67 +54 +77 +64
0 -39	0 -62	± 5.5	± 8	± 12	+13 +2	+18 +2	+20 +9	+25 +9	+33 +17	+42 +26	+50 +34	+59 +43	+64 +48 +70 +54	+76 +60 +86 +70	—
0 -46	0 -74	± 6.5	± 9.5	± 15	+15 +2	+21 +2	+24 +11	+30 +11	+39 +20	+51 +32	+60 +41 +62 +43	+72 +53 +78 +59	+85 +66 +94 +75	+106 +87 +121 +102	—
0 -54	0 -87	± 7.5	± 11	± 17	+18 +3	+25 +3	+28 +13	+35 +13	+45 +23	+59 +37	+73 +51 +76 +54	+93 +71 +101 +79	+113 +91 +126 +104	+146 +124 +166 +144	—
0 -63	0 -100	± 9	± 12.5	± 20	+21 +3	+28 +3	+33 +15	+40 +15	+52 +27	+68 +43	+88 +63 +90 +65 +93 +68	+117 +92 +125 +100 +133 +108	+147 +122 +159 +134 +171 +146	—	—
0 -72	0 -115	± 10	± 14.5	± 23	+24 +4	+33 +4	+37 +17	+46 +17	+60 +31	+79 +50	+106 +77 +109 +80 +113 +84	+151 +122 +159 +130 +169 +140	—	—	—
0 -81	0 -130	± 11.5	± 16	± 26	+27 +4	+36 +4	+43 +20	+52 +20	+66 +34	+88 +56	+126 +94 +130 +98	—	—	—	—
0 -89	0 -140	± 12.5	± 18	± 28	+29 +4	+40 +4	+46 +21	+57 +21	+73 +37	+98 +62	+144 +108 +150 +114	—	—	—	—
0 -97	0 -155	± 13.5	± 20	± 31	+32 +5	+45 +5	+50 +23	+63 +23	+80 +40	+108 +68	+166 +126 +172 +132	—	—	—	—

ŚREDNICE WIERTEŁ POD GWINT

● Gwint metryczny zwykły (grubozwojny)

Wymiar nominalny	Średnica wiertła	
	HSS	Węglik spiekany
M1 ×0.25	0.75	0.75
M1.1×0.25	0.85	0.85
M1.2×0.25	0.95	0.95
M1.4×0.3	1.10	1.10
M1.6×0.35	1.25	1.30
M1.7×0.35	1.35	1.40
M1.8×0.35	1.45	1.50
M2 ×0.4	1.60	1.65
M2.2×0.45	1.75	1.80
M2.3×0.4	1.90	1.95
M2.5×0.45	2.10	2.15
M2.6×0.45	2.15	2.20
M3 ×0.5	2.50	2.55
M3.5×0.6	2.90	2.95
M4 ×0.7	3.3	3.4
M4.5×0.75	3.8	3.9
M5 ×0.8	4.2	4.3
M6 ×1.0	5.0	5.1
M7 ×1.0	6.0	6.1
M8 ×1.25	6.8	6.9
M9 ×1.25	7.8	7.9
M10×1.5	8.5	8.7
M11×1.5	9.5	9.7
M12×1.75	10.3	10.5
M14×2.0	12.0	12.2
M16×2.0	14.0	14.2
M18×2.5	15.5	15.7
M20×2.5	17.5	17.7
M22×2.5	19.5	19.7
M24×3.0	21.0	—
M27×3.0	24.0	—
M30×3.5	26.5	—
M33×3.5	29.5	—
M36×4.0	32.0	—
M39×4.0	35.0	—
M42×4.5	37.5	—
M45×4.5	40.5	—
M48×5.0	43.0	—

● Gwint metryczny drobnozwojny

Wymiar nominalny	Średnica wiertła	
	HSS	Węglik spiekany
M1 ×0.2	0.80	0.80
M1.1×0.2	0.90	0.90
M1.2×0.2	1.00	1.00
M1.4×0.2	1.20	1.20
M1.6×0.2	1.40	1.40
M1.8×0.2	1.60	1.60
M2 ×0.25	1.75	1.75
M2.2×0.25	1.95	2.00
M2.5×0.35	2.20	2.20
M3 ×0.35	2.70	2.70
M3.5×0.35	3.20	3.20
M4 ×0.5	3.50	3.55
M4.5×0.5	4.00	4.05
M5 ×0.5	4.50	4.55
M5.5×0.5	5.00	5.05
M6 ×0.75	5.30	5.35
M7 ×0.75	6.30	6.35
M8 ×1.0	7.00	7.10
M8 ×0.75	7.30	7.35
M9 ×1.0	8.00	8.10
M9 ×0.75	8.30	8.35
M10×1.25	8.80	8.90
M10×1.0	9.00	9.10
M10×0.75	9.30	9.35
M11×1.0	10.0	10.1
M11×0.75	10.3	10.3
M12×1.5	10.5	10.7
M12×1.25	10.8	10.9
M12×1.0	11.0	11.1
M14×1.5	12.5	12.7
M14×1.0	13.0	13.1
M15×1.5	13.5	13.7
M15×1.0	14.0	14.1
M16×1.5	14.5	14.7
M16×1.0	15.0	15.1
M17×1.5	15.5	15.7
M17×1.0	16.0	16.1
M18×2.0	16.0	16.3
M18×1.5	16.5	16.7
M18×1.0	17.0	17.1

Wymiar nominalny	Średnica wiertła	
	HSS	Węglik spiekany
M20×2.0	18.0	18.3
M20×1.5	18.5	18.7
M20×1.0	19.0	19.1
M22×2.0	20.0	—
M22×1.5	20.5	—
M22×1.0	21.0	—
M24×2.0	22.0	—
M24×1.5	22.5	—
M24×1.0	23.0	—
M25×2.0	23.0	—
M25×1.5	23.5	—
M25×1.0	24.0	—
M26×1.5	24.5	—
M27×2.0	25.0	—
M27×1.5	25.5	—
M27×1.0	26.0	—
M28×2.0	26.0	—
M28×1.5	26.5	—
M28×1.0	27.0	—
M30×3.0	27.0	—
M30×2.0	28.0	—
M30×1.5	28.5	—
M30×1.0	29.0	—
M32×2.0	30.0	—
M32×1.5	30.5	—
M33×3.0	30.0	—
M33×2.0	31.0	—
M33×1.5	31.5	—
M35×1.5	33.5	—
M36×3.0	33.0	—
M36×2.0	34.0	—
M36×1.5	34.5	—
M38×1.5	36.5	—
M39×3.0	36.0	—
M39×2.0	37.0	—
M39×1.5	37.5	—
M40×3.0	37.0	—
M40×2.0	38.0	—
M40×1.5	38.5	—
M42×4.0	38.0	—

Wymiar nominalny	Średnica wiertła	
	HSS	Węglik spiekany
M42×3.0	39.0	—
M42×2.0	40.0	—
M42×1.5	40.5	—
M45×4.0	41.0	—
M45×3.0	42.0	—
M45×2.0	43.0	—
M45×1.5	43.5	—
M48×4.0	44.0	—
M48×3.0	45.0	—
M48×2.0	46.0	—
M48×1.5	46.5	—
M50×3.0	47.0	—
M50×2.0	48.0	—
M50×1.5	48.5	—

Uwaga 1) Wymiary otworów należy mierzyć, ponieważ dokładność wierconego otworu może ulec zmianie zależnie od parametrów wiercenia i jeśli okażą się niewłaściwe pod gwint, należy odpowiednio dobrać średnicę wiertła.

WYMIARY GNIAZD ŚRUB IMBUSOWYCH

WYMIARY POGŁĘBIŃ NA ŚRUBY IMBUSOWE I OTWORÓW NA ŚRUBĘ Jednostka : mm

Średnica nominalna gwintu d	M3	M4	M5	M6	M8	M10	M12	M14	M16	M18	M20	M22	M24	M27	M30
d₁	3	4	5	6	8	10	12	14	16	18	20	22	24	27	30
d'	3.4	4.5	5.5	6.6	9	11	14	16	18	20	22	24	26	30	33
D	5.5	7	8.5	10	13	16	18	21	24	27	30	33	36	40	45
D'	6.5	8	9.5	11	14	17.5	20	23	26	29	32	35	39	43	48
H	3	4	5	6	8	10	12	14	16	18	20	22	24	27	30
H'	2.7	3.6	4.6	5.5	7.4	9.2	11	12.8	14.5	16.5	18.5	20.5	22.5	25	28
H''	3.3	4.4	5.4	6.5	8.6	10.8	13	15.2	17.5	19.5	21.5	23.5	25.5	29	32

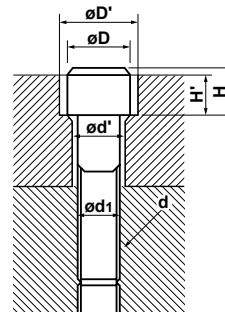
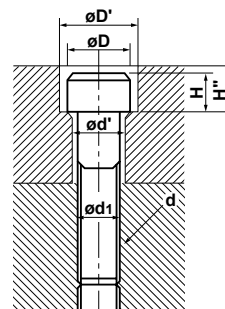

MIĘDZYNARODOWY UKŁAD JEDNOSTEK MIARY

■ TABELA PRZELICZENIOWA JEDNOSTEK MIARY do łatwiejszego przeliczania na jednostki SI (czcionką pogrubioną zaznaczono jednostki SI)

● Ciśnienie

Pa	kPa	MPa	bar	kgf/cm ²	atm	mmH ₂ O	mmHg lub Torr
1	1×10 ⁻³	1×10 ⁻⁶	1×10 ⁻⁵	1.01972×10 ⁻⁵	9.86923×10 ⁻⁶	1.01972×10 ⁻¹	7.50062×10 ⁻³
1×10 ³	1	1×10 ⁻³	1×10 ⁻²	1.01972×10 ⁻²	9.86923×10 ⁻³	1.01972×10 ²	7.50062
1×10 ⁶	1×10 ³	1	1×10	1.01972×10	9.86923	1.01972×10 ⁵	7.50062×10 ³
1×10 ⁵	1×10 ²	1×10 ⁻¹	1	1.01972	9.86923×10 ⁻¹	1.01972×10 ⁴	7.50062×10 ²
9.80665×10 ⁴	9.80665×10	9.80665×10 ⁻²	9.80665×10 ⁻¹	1	9.67841×10 ⁻¹	1×10 ⁴	7.35559×10 ²
1.01325×10 ⁵	1.01325×10 ²	1.01325×10 ⁻¹	1.01325	1.03323	1	1.03323×10 ⁴	7.60000×10 ²
9.80665	9.80665×10 ⁻³	9.80665×10 ⁻⁶	9.80665×10 ⁻⁵	1×10 ⁻⁴	9.67841×10 ⁻⁵	1	7.35559×10 ⁻²
1.33322×10 ²	1.33322×10 ⁻¹	1.33322×10 ⁻⁴	1.33322×10 ⁻³	1.35951×10 ⁻³	1.31579×10 ⁻³	1.35951×10	1

Uwaga 1) 1Pa=1N/m²

● Siła

N	dyn	kgf
1	1×10 ⁵	1.01972×10 ⁻¹
1×10 ⁻⁵	1	1.01972×10 ⁻⁶
9.80665	9.80665×10 ⁵	1

● Napężenie

Pa	MPa lub N/mm ²	kgf/mm ²	kgf/cm ²
1	1×10 ⁻⁶	1.01972×10 ⁻⁷	1.01972×10 ⁻⁵
1×10 ⁶	1	1.01972×10 ⁻¹	1.01972×10
9.80665×10 ⁶	9.80665	1	1×10 ²
9.80665×10 ⁴	9.80665×10 ⁻²	1×10 ⁻²	1

Uwaga 1) 1Pa=1N/m²

● Praca / Energia / Ciepło

J	kW·h	kgf·m	kcal
1	2.77778×10 ⁻⁷	1.01972×10 ⁻¹	2.38889×10 ⁻⁴
3.600 ×10 ⁶	1	3.67098×10 ⁵	8.6000 ×10 ²
9.80665	2.72407×10 ⁻⁶	1	2.34270×10 ⁻³
4.18605×10 ³	1.16279×10 ⁻³	4.26858×10 ²	1

Uwaga 1) 1J=1W·s, 1J=1N·m

1cal=4.18605J

(Według obowiązującej ustawy o wagach i miarach)

● Moc (Strumień energii / Siła napędowa) / Strumień ciepła

W	kgf·m/s	PS	kcal/h
1	1.01972×10 ⁻¹	1.35962×10 ⁻³	8.6000 ×10 ⁻¹
9.80665	1	1.33333×10 ⁻²	8.43371
7.355 ×10 ²	7.5 ×10	1	6.32529×10 ²
1.16279	1.18572×10 ⁻¹	1.58095×10 ⁻³	1

Uwaga 1) 1W=1J/s, PS:Korń mechaniczny (francuski)

1PS=0.7355kW

1cal=4.18605J

(Według obowiązującej ustawy o wagach i miarach)

INFORMACJE TECHNICZNE

Notatki

A series of horizontal dashed lines for writing notes, spanning the width of the page.

INDEKS

INDEKS OZNACZEŃ NARZĘDZI

A.....	2
B.....	2
C.....	2
D.....	2
E.....	2
F.....	2
G.....	2
H.....	2
J.....	2
K.....	2
L.....	2
M.....	3
N.....	3
P.....	3
R.....	3
S.....	3
T.....	4
U.....	4
V.....	4
W.....	4



INDEKS OZNACZEŃ NARZĘDZI

Numer zamówieniowy	Nazwa produktu	Strona	Numer zamówieniowy	Nazwa produktu	Strona
A			F		
AJS	Wkręt dociskowy	N003	FC400890T	Wkręt dociskowy	N004
AMS	Płytko dociskowa	N015	G		
B			GY05016S	Wkręt dociskowy	N004
BCP	Tuleja sprężysta	N014	GY06013M	Wkręt dociskowy	N004
BOES101	Śruba zaciskowa	N009	H		
BPT322	Płytko podporowa	N011	HBH	Wkręt dociskowy	N002
BRS	Wkręt dociskowy	N003	HBHA	Wkręt dociskowy	N002
C			HDS	Wkręt dociskowy	N009
CA	Płytko dociskowa	N015	HFF06015	Wkręt dociskowy	N004
CAS51T	Wkręt mocujący	N003	HFF080	Wkręt dociskowy	N009
CBS	Łamacz wióra	N017	HKY	Śrubokręt	N002
CBS	Łamacz wióra	N017	HKY	Klucz flagowy	N002
CBT	Łamacz wióra	N017	HKY	Klucz typu L	N002
CBT	Łamacz wióra	N017	HKY	Klucz typu L	N002
CBT	Łamacz wióra	N017	HKY	Klucz z gniazdem czworokątnym	N002
CCK	Płytko dociskowa	N015	HKY	Klucz flagowy	N002
CCP	Tuleja sprężysta	N014	HS	Wkręt dociskowy	N004
CCTC1	Płytko dociskowa	N015	HSC	Wkręt dociskowy	N002, N009
CK	Płytko dociskowa	N015	HSC	Śruba zaciskowa	N009
CKW6	Płytko dociskowa	N016	HSCX	Śruba zaciskowa	N009
CS	Płytko podporowa	N011	HSP05008C	Wkręt zaciskowy	N004
CSF401260T	Wkręt dociskowy	N003	HSS	Wkręt dociskowy	N002
CS	Wkręt dociskowy	N003	HY	Śruba	N004
CS	Wkręt dociskowy	N003	HY-A1	Śruba	N004
CS	Wkręt dociskowy	N003	HY-V1	Śruba	N004
CS	Wkręt dociskowy	N003	J		
CT	Płytko podporowa	N011	JFS	Numer zestawu tulei mimośrodowej	M172
CT32T1	Płytko podporowa	N012	JFS	Tuleja mimośrodowa JFS	M172
D			JSS	Śruba płytki podporowej	N004
DCK	Płytko dociskowa	N016	K		
DCSVN32	Płytko podporowa	N011	KGC1	Płytko dociskowa	N016
DC	Wkręt dociskowy	N003	KS	Śruba mocująca w kierunku poosiowym	N004
DKS	Wkręt dociskowy	N003	KS	Śruba zaciskowa	N004
DLE	Wiodący typ nawiertaków DLE	M012, M013	KSN	Wkręt dociskowy	N010
DSAS	Wiertło typu DSAS	M096–M098	KSN3	Nakrętka do mikroregulacji	N010
DVAS	Wiertło typu MINI-DVAS	M028–M031	KS	Śruba ustalająca	N004
DWAE	Wiertło typu MINI-DWAE	M020	KSS	Wkręt dociskowy	N010
DWAE	Wiertło typu DWAE	M021–M026	KSS2	Śruba do regulacji zgrubnej	N010
E			L		
EGS	Wkręt dociskowy	N004	LK1	Płytko dociskowa	N016
ESS42	Płytko podporowa	N011	LLCL	Dźwignia dociskowa	N014
EST	Płytko podporowa	N011	LLCL	Dźwignia dociskowa	N014
			LLCS	Wkręt dociskowy	N005

INDEKS OZNACZEŃ NARZĘDZI

Numer zamówieniowy	Nazwa produktu	Strona	Numer zamówieniowy	Nazwa produktu	Strona
SETS	Wkręt dociskowy	N006	W		
SLCS	Wkręt dociskowy	N006	WCS	Śruba płytki podporowej	N008
SOMX	Płytki (Do wiertła typu MVX)	M168	WPSTN	Płytki podporowe	N013
SPSVN32	Płytki podporowe	N013	WPSWC43	Płytki podporowe	N013
SPS1	Śruba lokatora	N006	WPSWN43	Płytki podporowe	N013
SRK1R	Płytki dociskowe	N016	WPT4405	Płytki czyszcząca (Do wiertła typu TAW)	M150–M154
SRS5	Wkręt dociskowy	N006	WS	Wkręt dociskowy	N008
STASX	Płytki podporowe	N013	WS	Wkręt dociskowy	N008
STAWN	Wiertło typu STAW	M141–M143	T		
STAWN	Płytki (Do wiertła typu STAW)	M145	TAWN	Płytki (Do wiertła typu TAW)	M155, M156
STAWN	Płytki (Do wiertła typu STAW)	M144, M145	TAWN	Wiertło typu TAW (Zastosowanie uniwersalne)	M150–M154
STAW	Wiertło typu STAW	M141–M143	TIP	Klucz płaski	N002
STBS500N	Płytki podporowe	N013	TKYD	Śrubokręt	N002
STS1	Śruba płytki podporowej	N006	TKYF	Klucz flagowy	N002
T			TKYL	Długi klucz	N002
TAWN	Płytki (Do wiertła typu TAW)	M155, M156	TKYR	Klucz typu L	N002
TAWN	Wiertło typu TAW (Zastosowanie uniwersalne)	M150–M154	TKYT	Klucz z gniazdem czworokątnym	N002
TIP	Klucz płaski	N002	TKYW	Klucz flagowy	N002
TKYD	Śrubokręt	N002	TPS	Wkręt dociskowy	N008
TKYF	Klucz flagowy	N002	TPS	Wkręt dociskowy	N008
TKYL	Długi klucz	N002	TPS	Wkręt dociskowy	N008
TKYR	Klucz typu L	N002	TPS	Wkręt dociskowy	N008
TKYT	Klucz z gniazdem czworokątnym	N002	TPS-1	Wkręt dociskowy	N008
TKYW	Klucz flagowy	N002	TS	Wkręt dociskowy	N007
TPS	Wkręt dociskowy	N008	TS	Wkręt dociskowy	N007
TPS	Wkręt dociskowy	N008	TS	Wkręt dociskowy	N007
TPS	Wkręt dociskowy	N008	TS	Wkręt dociskowy	N007
TPS-1	Wkręt dociskowy	N008	TSR	Wkręt dociskowy	N008
TS	Wkręt dociskowy	N007	TSS	Śruba mocująca w kierunku promieniowym	N008
TS	Wkręt dociskowy	N007	TSS	Wkręt dociskowy	N008
TS	Wkręt dociskowy	N007	U		
TSR	Wkręt dociskowy	N008	UCR	Płytki dociskowe	N016
TSS	Śruba mocująca w kierunku promieniowym	N008	V		
TSS	Wkręt dociskowy	N008	VAPDM	Wiertła VIOLET	M179–M181
U			VAPDS	Wiertła VIOLET	M174–M177
UCR	Płytki dociskowe	N016	VAPDSCB	Wiertła VIOLET	M185, M186
V			VSD	Wiertła VIOLET, chwyt walcowy	M183, M184
VAPDM	Wiertła VIOLET	M179–M181			
VAPDS	Wiertła VIOLET	M174–M177			
VAPDSCB	Wiertła VIOLET	M185, M186			
VSD	Wiertła VIOLET, chwyt walcowy	M183, M184			

GERMANY

MMC HARTMETALL GMBH
Comeniusstr. 2 . 40670 Meerbusch
Phone +49 2159 91890 . Fax +49 2159 918966
Email admin@mmchg.de

U.K.

MMC HARDMETAL U.K. LTD.
Mitsubishi House . Galena Close . Tamworth . Staffs. B77 4AS
Phone +44 1827 312312 . Fax +44 1827 312314
Email sales@mitsubishicarbide.co.uk

SPAIN

MITSUBISHI MATERIALS ESPAÑA, S.A.
Calle Emperador 2 . 46136 Museros/Valencia
Phone +34 96 1441711 . Fax +34 96 1443786
Email comercial@mmevalencia.es

FRANCE

MMC METAL FRANCE S.A.R.L.
6, Rue Jacques Monod . 91400 Orsay
Phone +33 1 69 35 53 53 . Fax +33 1 69 35 53 50
Email mmfsales@mmc-metal-france.fr

POLAND

MMC HARDMETAL POLAND SP. Z O.O
Al. Armii Krajowej 61 . 50 - 541 Wrocław
Phone +48 71335 1620 . Fax +48 71335 1621
Email sales@mitsubishicarbide.com.pl

ITALY

MMC ITALIA S.R.L.
Viale Certosa 144 . 20156 Milano
Phone +39 0293 77031 . Fax +39 0293 589093
Email info@mmc-italia.it

TURKEY

MMC HARTMETALL GMBH ALMANYA - İZMİR MERKEZ ŞUBESİ
Adalet Mahallesi Anadolu Caddesi No: 41-1 . 15001 35580 Bayraklı/İzmir
Phone +90 232 5015000 . Fax +90 232 5015007
Email info@mmchg.com.tr